

54010-1 ✓ ACTIVE

AMP | AMP CPC

TE Internal #: 54010-1

Circular Connector Seals, Cable Seal, Cable-to-Cable, .625-24
UNEF-2B, Sealable, Wire & Cable, Cable Mount (Free-Hanging),
AMP CPC

[View on TE.com >](#)



Connectors > Circular Connectors > Circular Connector Accessories > Circular Connector Seals > HEAT SHRINK STRAIN RELIEFS-CPC



Connector Seal Type: **Cable Seal**

Connector System: **Cable-to-Cable**

Accepts Cable Diameter Range: **6.35 – 15.24 mm [.25 – .6 in]**

Screw & Hole Thread Size: **.625-24 UNEF-2B**

Sealable: **Yes**

[All HEAT SHRINK STRAIN RELIEFS-CPC \(7\)](#)

Features

Product Type Features

| | |
|-----------------------------------|----------------|
| Connector Seal Type | Cable Seal |
| Connector System | Cable-to-Cable |
| Sealable | Yes |
| Connector & Contact Terminates To | Wire & Cable |

Body Features

| | |
|-------|-------|
| Color | Black |
|-------|-------|

Mechanical Attachment

| | |
|--------------------------|----------------------------|
| Screw & Hole Thread Size | .625-24 UNEF-2B |
| Connector Mounting Type | Cable Mount (Free-Hanging) |

Dimensions

| | |
|------------------------------|-------------------------------|
| Accepts Cable Diameter Range | 6.35 – 15.24 mm [.25 – .6 in] |
|------------------------------|-------------------------------|

Usage Conditions



| | |
|-----------------------------|----------------------------|
| Operating Temperature Range | -55 – 110 °C[-67 – 230 °F] |
|-----------------------------|----------------------------|

Packaging Features

| | |
|--------------------|--------|
| Packaging Quantity | 50 |
| Packaging Method | Carton |

Product Compliance

[For compliance documentation, visit the product page on TE.com>](#)

| | |
|---|--|
| EU RoHS Directive 2011/65/EU | Compliant |
| EU ELV Directive 2000/53/EC | Compliant |
| China RoHS 2 Directive MIIT Order No 32, 2016 | No Restricted Materials Above Threshold |
| EU REACH Regulation (EC) No. 1907/2006 | Current ECHA Candidate List: JUNE 2022 (224) Candidate List Declared Against: JAN 2021 (211) SVHC > Threshold: Not Yet Reviewed |
| Halogen Content | BFR/CFR/PVC Free, but Br/Cl >900 ppm in other sources. |
| Solder Process Capability | Not applicable for solder process capability |

Product Compliance Disclaimer

This information is provided based on reasonable inquiry of our suppliers and represents our current actual knowledge based on the information they provided. This information is subject to change. The part numbers that TE has identified as EU RoHS compliant have a maximum concentration of 0.1% by weight in homogenous materials for lead, hexavalent chromium, mercury, PBB, PBDE, DBP, BBP, DEHP, DIBP, and 0.01% for cadmium, or qualify for an exemption to these limits as defined in the Annexes of Directive 2011/65/EU (RoHS2). Finished electrical and electronic equipment products will be CE marked as required by Directive 2011/65/EU. Components may not be CE marked. Additionally, the part numbers that TE has identified as EU ELV compliant have a maximum concentration of 0.1% by weight in homogenous materials for lead, hexavalent chromium, and mercury, and 0.01% for cadmium, or qualify for an exemption to these limits as defined in the Annexes of Directive 2000/53/EC (ELV). Regarding the REACH Regulation, the information TE provides on SVHC in articles for this part number is based on the latest European Chemicals Agency (ECHA) 'Guidance on requirements for substances in articles' posted at this URL: <https://echa.europa.eu/guidance-documents/guidance-on-reach>

Compatible Parts

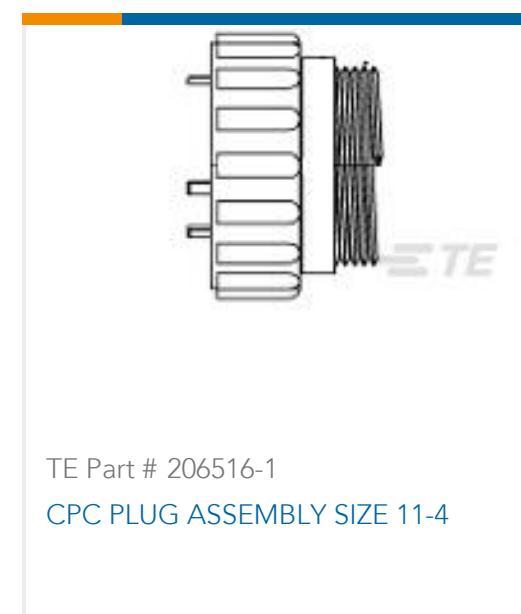



Also in the Series | AMP CPC

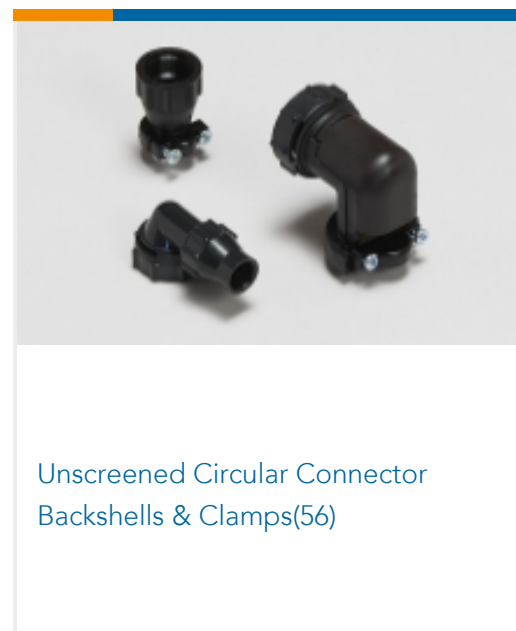
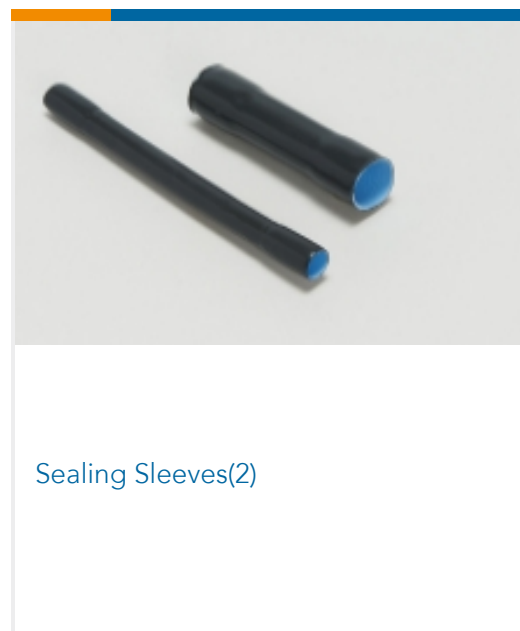
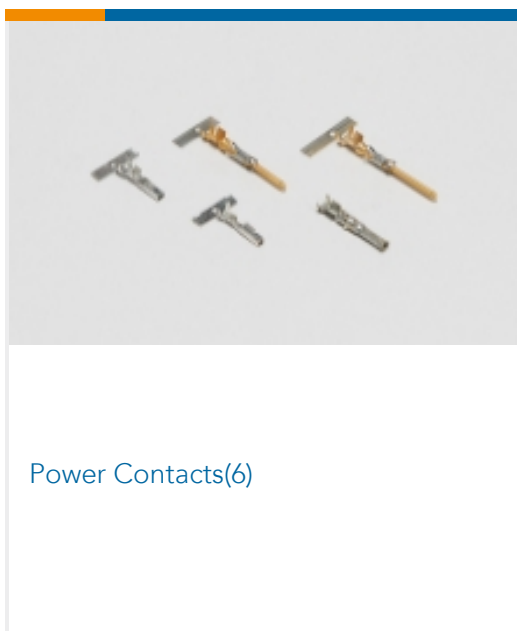
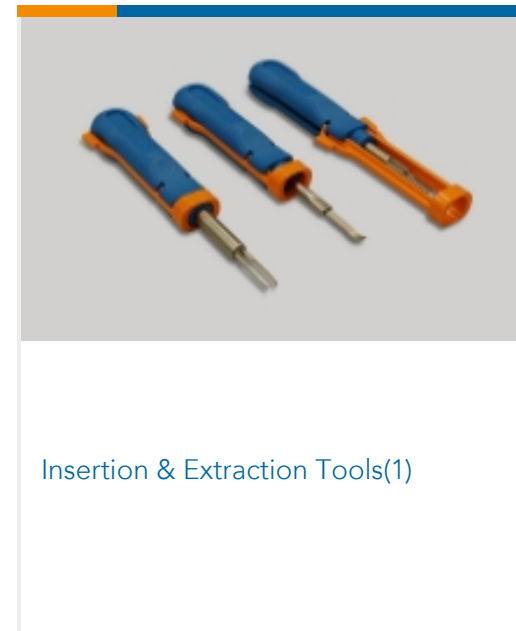
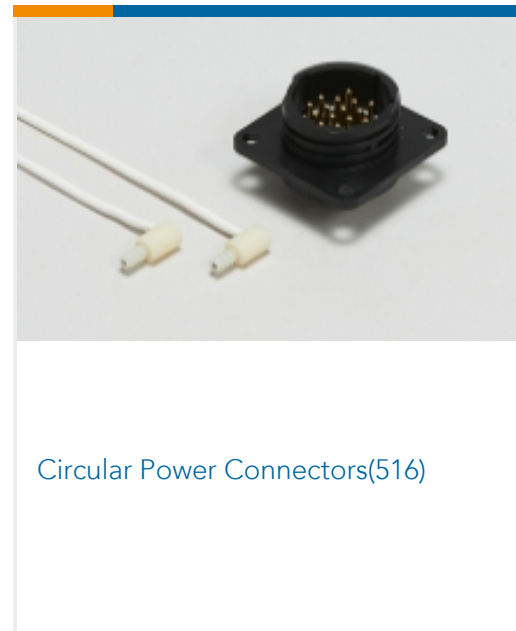
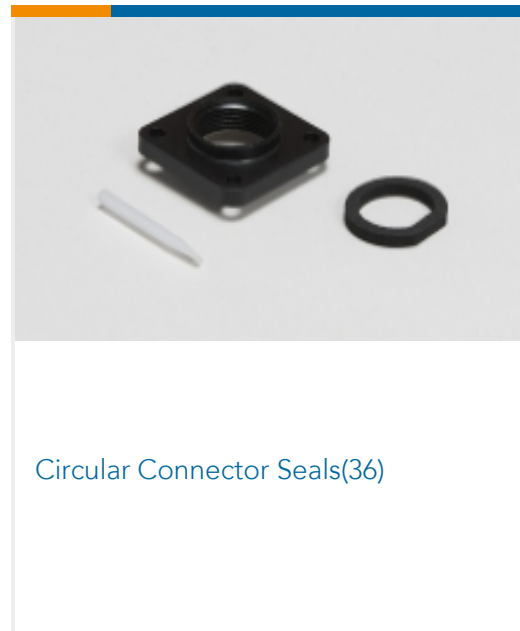
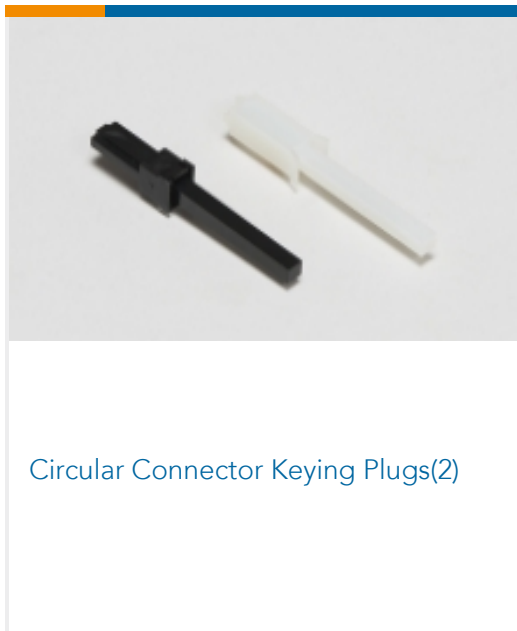
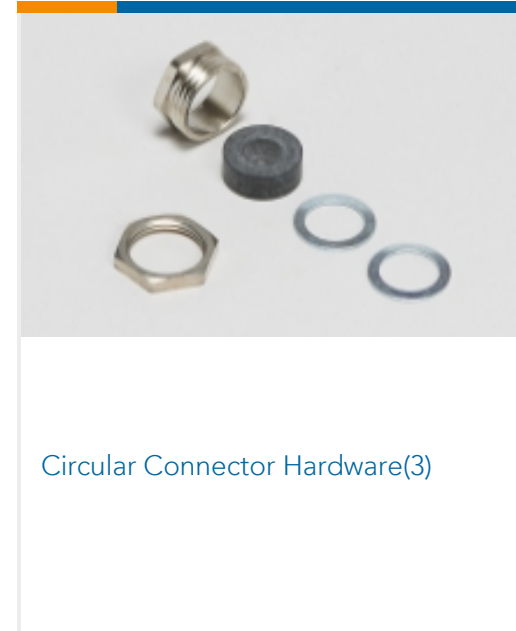
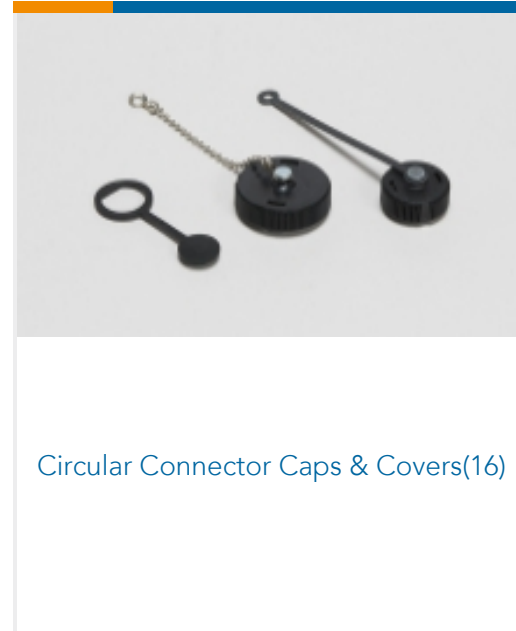
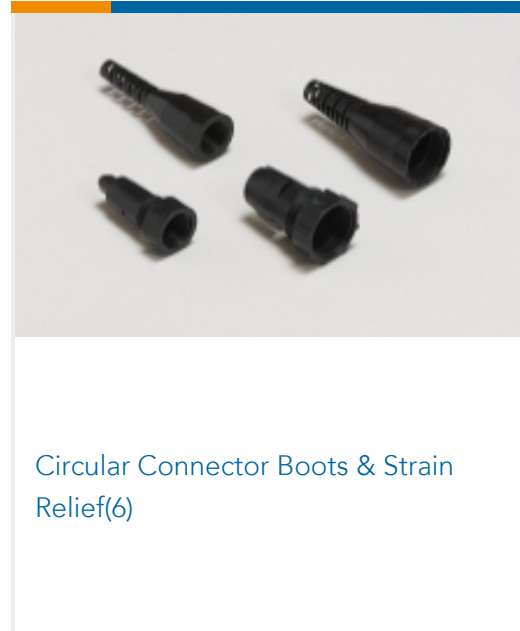
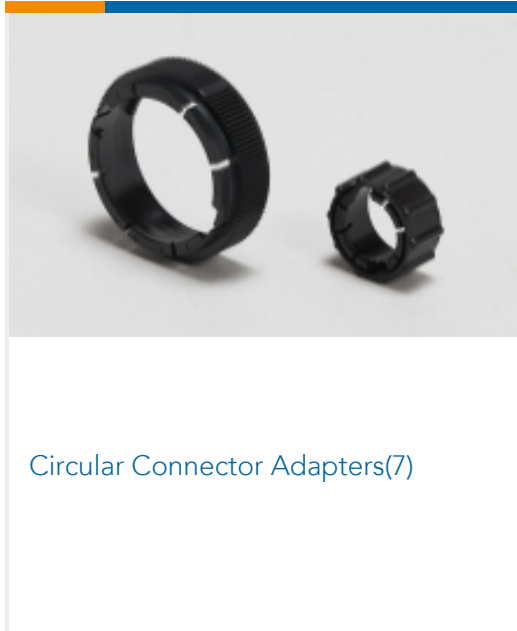

Customers Also Bought



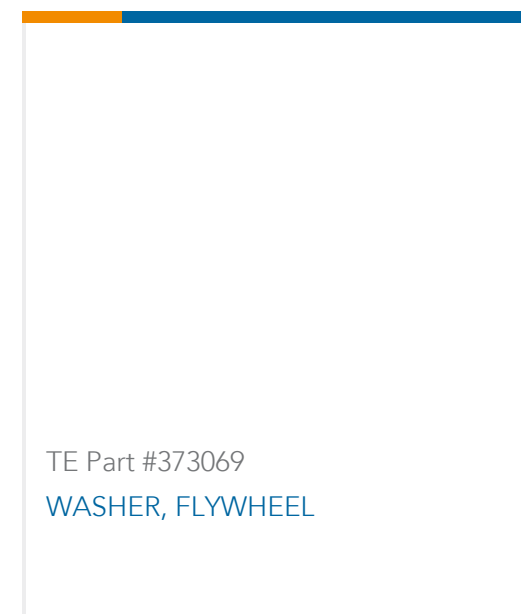

Documents

Product Drawings

CPC STRAIN RELIEF,SIZE 11

English

CAD Files

3D PDF

English

Customer View Model

[ENG_CVM_54010-1_AC.3d_igs.zip](#)

English

Customer View Model

[ENG_CVM_54010-1_AC.3d_stp.zip](#)

English

Customer View Model

[ENG_CVM_54010-1_AC.2d_dxf.zip](#)

English

3D PDF

3D

Customer View Model

[ENG_CVM_CVM_54010-1_AB.2d_dxf.zip](#)

English

Customer View Model

[ENG_CVM_CVM_54010-1_AB.3d_igs.zip](#)

English

Customer View Model

[ENG_CVM_CVM_54010-1_AB.3d_stp.zip](#)

English

By downloading the CAD file I accept and agree to the [Terms and Conditions](#) of use.

Datasheets & Catalog Pages

AMP Circular Connectors for Commercial Signal & Power Applications Continued

English

Product Specifications

Application Specification

English



Product Environmental Compliance

Product Compliance

English

Product Compliance

English

Instruction Sheets

Instruction Sheet (U.S.)

English