

52043-2 ✓ ACTIVE

PLASTI-GRIP

TE Internal #: 52043-2

Ring Terminals & Spade Terminals, Ring Tongue, 4 AWG Wire Size,
21.2 mm² Wire Size, 33100 – 52600 CMA Wire Size, Stud Size #10,
PLASTI-GRIP

[View on TE.com >](#)



Terminals & Splices > Ring Terminals & Spade Terminals

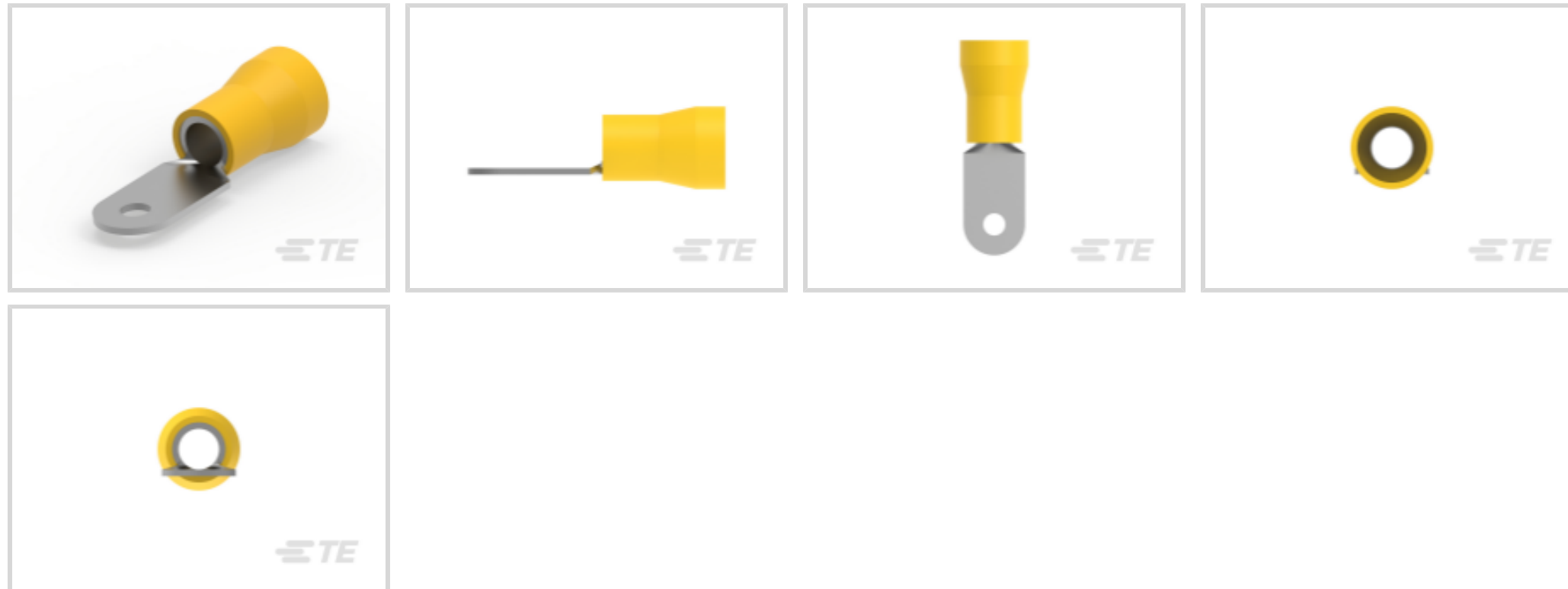

Ring & Spade Terminal Type: **Ring Tongue**

Wire Size: **33100 – 52600 CMA**

Stud Size: **#10**

Features

Product Type Features

Shape Description	RING-044
Stud Size	#10
Sealable	No
Wire Insulation Support Retention Type	Insulation Support

Configuration Features

Number of Holes	1
Terminal Angle	180 °

Electrical Characteristics

Voltage (Max)	600 V
---------------	-------

Body Features

Inspection Slot	No
-----------------	----

Contact Features

Ring & Spade Terminal Type	Ring Tongue
Barrel Type	Closed
Terminal Orientation	Offset



Terminal Plating Material	Tin
---------------------------	-----

Mechanical Attachment

Wire Insulation Support	With
-------------------------	------

Dimensions

Wire Size	33100 – 52600 CMA
-----------	-------------------

Stud Diameter	5 mm[.197 in]
---------------	---------------

Tongue Thickness	.79 mm[.031 in]
------------------	-----------------

Overall Product Length	49.48 mm[1.948 in]
------------------------	--------------------

Accepts Wire Insulation Diameter (Max)	11.43 mm[.45 in]
--	------------------

Accepts Wire Insulation Diameter Range	11.43 mm[.45 in]
--	------------------

Usage Conditions

Insulation Option	Partially Insulated
-------------------	---------------------

Operating Temperature Range	105 °C[221 °F]
-----------------------------	----------------

Operation/Application

Compatible With Wire Base Material	Copper
------------------------------------	--------

Compatible With Wire Plating Material	Tin
---------------------------------------	-----

Heavy Duty	No
------------	----

Industry Standards

Government Qualified	No
----------------------	----

Packaging Features

Packaging Quantity	100
--------------------	-----

Packaging Method	Loose Piece
------------------	-------------

Product Compliance

[For compliance documentation, visit the product page on TE.com>](#)

EU RoHS Directive 2011/65/EU	Compliant
------------------------------	-----------

EU ELV Directive 2000/53/EC	Compliant
-----------------------------	-----------

China RoHS 2 Directive MIIT Order No 32, 2016	No Restricted Materials Above Threshold
---	---

EU REACH Regulation (EC) No. 1907/2006	Current ECHA Candidate List: JUNE 2022 (224) Candidate List Declared Against: JAN 2022 (223) SVHC > Threshold: Not Yet Reviewed
--	--



Halogen Content	Not Low Halogen - contains Br or Cl > 900 ppm.
-----------------	--

Solder Process Capability	Not applicable for solder process capability
---------------------------	--

Product Compliance Disclaimer

This information is provided based on reasonable inquiry of our suppliers and represents our current actual knowledge based on the information they provided. This information is subject to change. The part numbers that TE has identified as EU RoHS compliant have a maximum concentration of 0.1% by weight in homogenous materials for lead, hexavalent chromium, mercury, PBB, PBDE, DBP, BBP, DEHP, DIBP, and 0.01% for cadmium, or qualify for an exemption to these limits as defined in the Annexes of Directive 2011/65/EU (RoHS2). Finished electrical and electronic equipment products will be CE marked as required by Directive 2011/65/EU. Components may not be CE marked. Additionally, the part numbers that TE has identified as EU ELV compliant have a maximum concentration of 0.1% by weight in homogenous materials for lead, hexavalent chromium, and mercury, and 0.01% for cadmium, or qualify for an exemption to these limits as defined in the Annexes of Directive 2000/53/EC (ELV). Regarding the REACH Regulation, the information TE provides on SVHC in articles for this part number is based on the latest European Chemicals Agency (ECHA) 'Guidance on requirements for substances in articles' posted at this URL: <https://echa.europa.eu/guidance-documents/guidance-on-reach>

Compatible Parts



TE Part # 1490599-1
HYP10 TERMINYL 4AWG DIE SET



TE Part # 47822
HYP8 TERMINYL 4AWG DIE SET



TE Part # 1490536-1
HYP10 PLASTI-GRIP 4AWG DIE SET



TE Part # 48754-1
HYP8 PLASTI-GRIP 4AWG 69051 DIE SET



TE Part # 48860-1
HYP8/10 PLASTI-GRIP/10 4AWG DIE SET

Also in the Series | PLASTI-GRIP



Compression Connectors(3)



Crimp Wire Pins, Tabs & Ferrules(25)



Ring Terminals & Spade Terminals(537)



Special Purpose Terminals(1)



Splices(49)

Customers Also Bought



TE Part #326882
TERMINAL,PIDG R 16-14 6

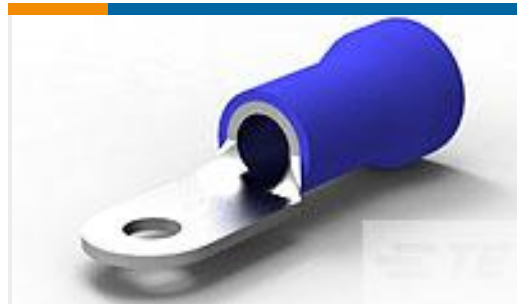

TE Part #52265
TERMINAL R PG 6 10

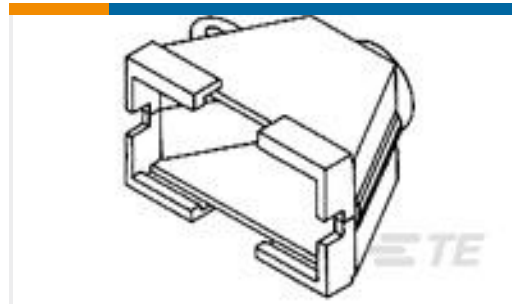

TE Part #350373-1
06P STR/REL HSG HNGD



TE Part #36808
TERMINAL,SOLIS R 6 1/2

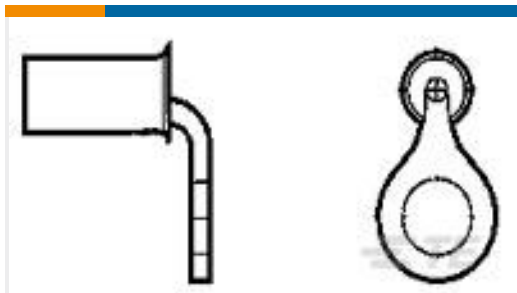

TE Part #322906
TERMINAL,SOLIS R 90DEG 1/0 3/8



TE Part #323291
TERMINAL,SOLIS R 2 1/2



TE Part #52042-2
TERMINAL,R PG 6 8



TE Part #52043-1
TERMINAL R PG 4 1/4



TE Part #52266
TERMINAL R PG 4 5/16

Documents

Product Drawings

[TERMINAL R PG 4 10](#)

English

CAD Files

[3D PDF](#)

3D

[Customer View Model](#)

[ENG_CVM_CVM_52043-2_P.2d_dxf.zip](#)



English

Customer View Model

[ENG_CVM_CVM_52043-2_P.3d_igs.zip](#)

English

Customer View Model

[ENG_CVM_CVM_52043-2_P.3d_stp.zip](#)

English

3D PDF

English

Customer View Model

[ENG_CVM_52043-2_L.2d_dxf.zip](#)

English

Customer View Model

[ENG_CVM_52043-2_L.3d_igs.zip](#)

English

Customer View Model

[ENG_CVM_52043-2_L.3d_stp.zip](#)

English

By downloading the CAD file I accept and agree to the [Terms and Conditions](#) of use.

Product Specifications

Application Specification

English

Product Environmental Compliance

MD_52043-2_01142014849_dmtec

English

MD_52043-2_01142014849_dmtec

English

Instruction Sheets

Instruction Sheet (U.S.)

English

Agency Approvals

UL Report

English