

52955-3 ✓ ACTIVE

PLASTI-GRIP

TE Internal #: 52955-3

Ring Terminals & Spade Terminals, Spring Spade, 16 – 14 AWG

Wire Size, 1.25 – 2 mm² Wire Size, 2050 – 5180 CMA Wire Size,

PLASTI-GRIP

[View on TE.com >](#)



Terminals & Splices > Ring Terminals & Spade Terminals

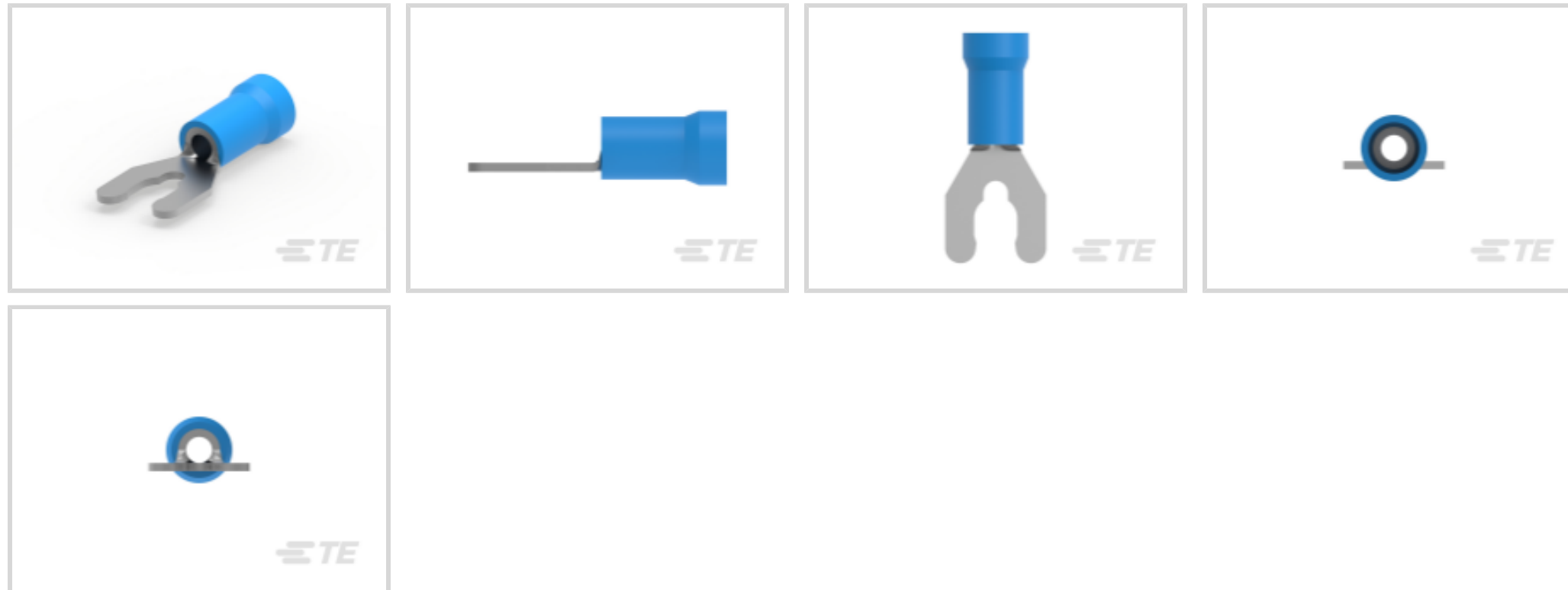

Ring & Spade Terminal Type: **Spring Spade**

Wire Size: **2050 – 5180 CMA**

Stud Size: **#6, M3.5**

Features

Product Type Features

Shape Description	SPADE-029
Stud Size	#6, M3.5
Sealable	No
Wire Insulation Support Retention Type	Insulation Support

Configuration Features

Terminal Angle	180 °
----------------	-------

Electrical Characteristics

Voltage (Max)	600 V
---------------	-------

Body Features

Inspection Slot	No
Insulation Sleeve Color	Red
Stripe Color	Red

Contact Features

Ring & Spade Terminal Type	Spring Spade
Barrel Type	Closed



Terminal Orientation	Offset
Terminal Plating Material	Tin

Mechanical Attachment

Wire Insulation Support	With
-------------------------	------

Dimensions

Wire Size	2050 – 5180 CMA
Stud Diameter	3.56 mm[.14 in]
Tongue Thickness	.79 mm[.031 in]
Overall Product Length	21.84 mm[.86 in]
Accepts Wire Insulation Diameter (Max)	6.35 mm[.25 in]
Accepts Wire Insulation Diameter Range	3.81 – 6.35 mm[.15 – .25 in]

Usage Conditions

Insulation Option	Partially Insulated
Operating Temperature Range	105 °C[221 °F]

Operation/Application

Compatible With Wire Base Material	Copper
Compatible With Wire Plating Material	Tin
Heavy Duty	No

Industry Standards

Government Qualified	No
----------------------	----

Packaging Features

Packaging Quantity	2500
Packaging Method	Tape Mounted

Product Compliance

[For compliance documentation, visit the product page on TE.com>](#)

EU RoHS Directive 2011/65/EU	Compliant
EU ELV Directive 2000/53/EC	Compliant
China RoHS 2 Directive MIIT Order No 32, 2016	No Restricted Materials Above Threshold
EU REACH Regulation (EC) No. 1907/2006	Current ECHA Candidate List: JUNE 2022 (224) Candidate List Declared Against: JAN 2022 (223)











SVHC > Threshold:
Not Yet Reviewed

Halogen Content	Not Low Halogen - contains Br or Cl > 900 ppm.
Solder Process Capability	Not applicable for solder process capability

Product Compliance Disclaimer

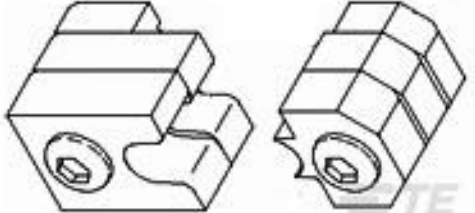
This information is provided based on reasonable inquiry of our suppliers and represents our current actual knowledge based on the information they provided. This information is subject to change. The part numbers that TE has identified as EU RoHS compliant have a maximum concentration of 0.1% by weight in homogenous materials for lead, hexavalent chromium, mercury, PBB, PBDE, DBP, BBP, DEHP, DIBP, and 0.01% for cadmium, or qualify for an exemption to these limits as defined in the Annexes of Directive 2011/65/EU (RoHS2). Finished electrical and electronic equipment products will be CE marked as required by Directive 2011/65/EU. Components may not be CE marked. Additionally, the part numbers that TE has identified as EU ELV compliant have a maximum concentration of 0.1% by weight in homogenous materials for lead, hexavalent chromium, and mercury, and 0.01% for cadmium, or qualify for an exemption to these limits as defined in the Annexes of Directive 2000/53/EC (ELV). Regarding the REACH Regulation, the information TE provides on SVHC in articles for this part number is based on the latest European Chemicals Agency (ECHA) 'Guidance on requirements for substances in articles' posted at this URL: <https://echa.europa.eu/guidance-documents/guidance-on-reach>

Compatible Parts

 <p>TE Part # 59824-1 TETRA-CRIMP PIDG PG FASTON 22-10 ASSY</p>	 <p>TE Part # 58433-3 PRO CR ASSY, RBY IS9252</p>	 <p>TE Part # 47387 DAHT PG PIDG 20-14 ASSY</p>	 <p>TE Part # 58423-1 DIE, RBY IS9252</p>
 <p>TE Part # 47807-1 DIES PIDG 16-14 DIE SET</p>	 <p>TE Part # 1SET191001R0000 CRIMP-HT</p>	 <p>TE Part # 1SET191002R0000 TET CRIMP-HT</p>	 <p>TE Part # 169404 CERTI-LOK DIE</p>

Also in the Series | **PLASTI-GRIP**



Compression Connectors(3)



Crimp Wire Pins, Tabs & Ferrules(25)



Ring Terminals & Spade Terminals(537)



Special Purpose Terminals(1)



Splices(49)

Customers Also Bought



TE Part #2-34806-2
PIDG RING TONGUE TERMINALS



TE Part #52957-1
TERMINAL,PG SPR SPD 16-14 10

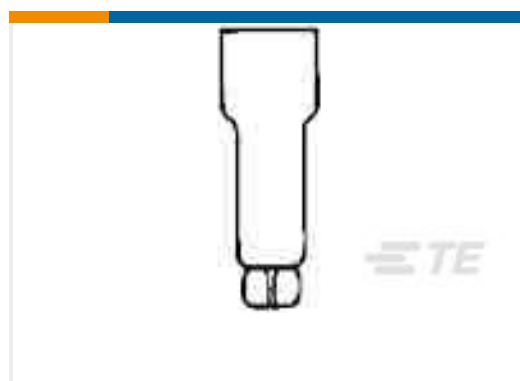

TE Part #55843-1
SPLICE,CE 22-14



TE Part #62109-1
250 FASTON REC 18-14 AWG BR



TE Part #2-32952-1
PG R 22-16 COMM 22-18 MIL 10



TE Part #52955-1
TERMINAL,PG SPR SPD 16-14 6

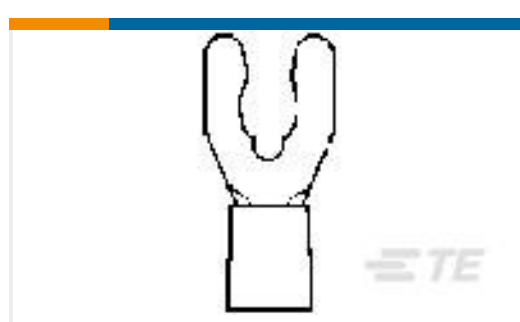

TE Part #52956-3
TERMINAL,PG SPR SPD 16-14 8



TE Part #52930-1
PIDG SP SPD 22-16COMM22-18MIL8

Documents

Product Drawings

[TERMINAL,PG SPR SPD 16-14 6](#)

English

CAD Files

[3D PDF](#)

English

[Customer View Model](#)

[ENG_CVM_52955-3_N1.3d_igs.zip](#)



English

Customer View Model

[ENG_CVM_52955-3_N1.3d_stp.zip](#)

English

Customer View Model

[ENG_CVM_52955-3_N1.2d_dxf.zip](#)

English

[3D PDF](#)

3D

Customer View Model

[ENG_CVM_CVM_52955-3_U.2d_dxf.zip](#)

English

Customer View Model

[ENG_CVM_CVM_52955-3_U.3d_igs.zip](#)

English

Customer View Model

[ENG_CVM_CVM_52955-3_U.3d_stp.zip](#)

English

By downloading the CAD file I accept and agree to the [Terms and Conditions](#) of use.

Product Specifications

[Application Specification](#)

English

Product Environmental Compliance

[MD_52955-3_05042018847_dmtec](#)

English

[MD_52955-3_05042018847_dmtec](#)

English

Instruction Sheets

[Instruction Sheet \(U.S.\)](#)

English

[LARGE EXPANSION PRODUCTS \(FOR WIRE INSTULATION WITH 1/16" AND 5/64" WA](#)

English

Agency Approvals

[UL Report](#)

English