

521358-1 ✓ ACTIVE

FASTON | FASTON 250

TE Internal #: 521358-1

Crimp Terminal Housings, Receptacle, Receptacle, 2 Position,
Straight, UL 94V-2, Natural, Nylon, Mating Alignment, FASTON 250

[View on TE.com >](#)



Terminals & Splices > Terminal Housings, Insulation Sleeves & Blocks > Crimp Terminal Housings



Terminal Type: **Receptacle**

Housing Type: **Receptacle**

Number of Positions: **2**

Terminal Orientation: **Straight**

UL Flammability Rating: **UL 94V-2**

Features

Product Type Features

Product Type	Terminal Housing
Sealable	No
Housing Type	Receptacle
Insulated	No

Configuration Features

Number of Positions	2
---------------------	---

Body Features

Primary Product Color	Natural
-----------------------	---------

Contact Features

Terminal Type	Receptacle
Terminal Orientation	Straight
Contact Mating Retention	Without

Mechanical Attachment

Mating Alignment	With
------------------	------



Crimp Terminal Housing Mounting Style

Cable Mount (Free-Hanging)

Housing Features

Housing Material

Nylon

Centerline (Pitch)

12.6 mm[.496 in]

Dimensions

Length

23.11 mm[.91 in]

Wire Size

5.26 mm²

Usage Conditions

Operating Temperature Range

-40 – 105 °C[-40 – 221 °F]

Industry Standards

UL Flammability Rating

UL 94V-2

Packaging Features

Packaging Quantity

1

Packaging Method

Carton

Product Compliance

[For compliance documentation, visit the product page on TE.com>](#)

EU RoHS Directive 2011/65/EU

Compliant

EU ELV Directive 2000/53/EC

Compliant

China RoHS 2 Directive MIIT Order No 32, 2016

No Restricted Materials Above Threshold

EU REACH Regulation (EC) No. 1907/2006

Current ECHA Candidate List: JUNE 2022 (224)
 Candidate List Declared Against: JAN 2022 (223)
 SVHC > Threshold:
 Not Yet Reviewed

Halogen Content

Low Halogen - Br, Cl, F, I < 900 ppm per homogenous material. Also BFR/CFR/PVC Free

Solder Process Capability

Not applicable for solder process capability

Product Compliance Disclaimer

This information is provided based on reasonable inquiry of our suppliers and represents our current actual knowledge based on the information they provided. This information is subject to change. The part numbers that TE has identified as EU RoHS compliant have a maximum concentration of 0.1% by weight in homogenous materials for lead, hexavalent chromium, mercury, PBB, PBDE, DBP, BBP, DEHP, DIBP, and 0.01% for cadmium, or qualify for an exemption to these limits as defined in the Annexes of Directive 2011/65/EU (RoHS2). Finished electrical and electronic equipment products will be CE marked as required by Directive 2011/65/EU. Components may not be CE marked. Additionally, the part

numbers that TE has identified as EU ELV compliant have a maximum concentration of 0.1% by weight in homogenous materials for lead, hexavalent chromium, and mercury, and 0.01% for cadmium, or qualify for an exemption to these limits as defined in the Annexes of Directive 2000/53/EC (ELV). Regarding the REACH Regulation, the information TE provides on SVHC in articles for this part number is based on the latest European Chemicals Agency (ECHA) 'Guidance on requirements for substances in articles' posted at this URL: <https://echa.europa.eu/guidance-documents/guidance-on-reach>

Compatible Parts



Also in the Series | FASTON 250

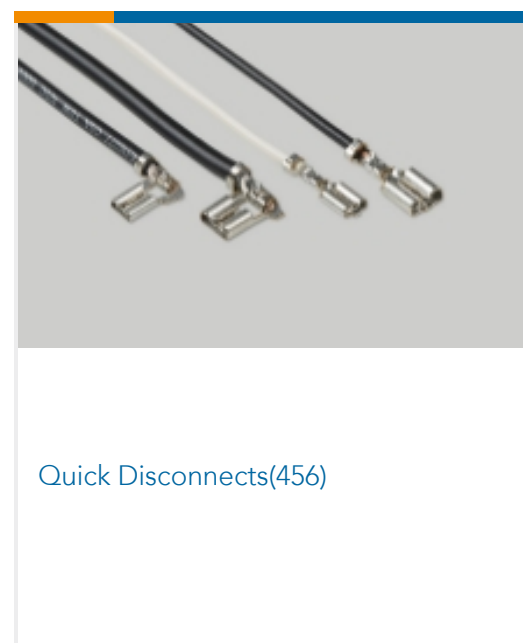
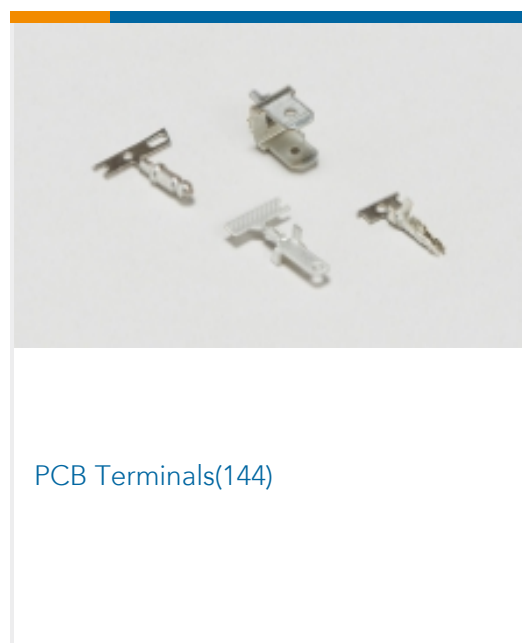
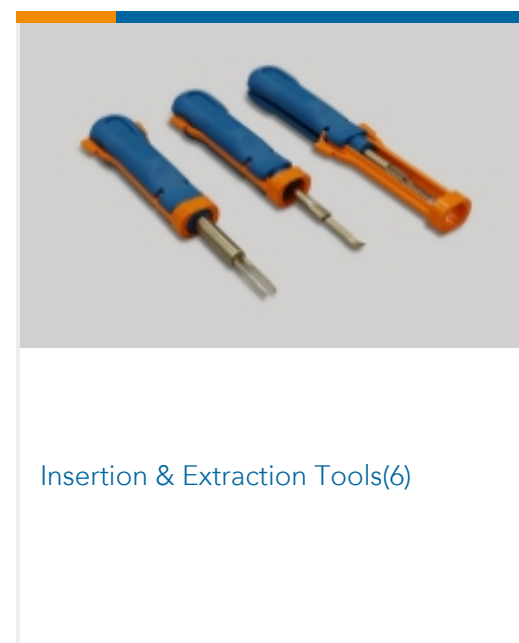
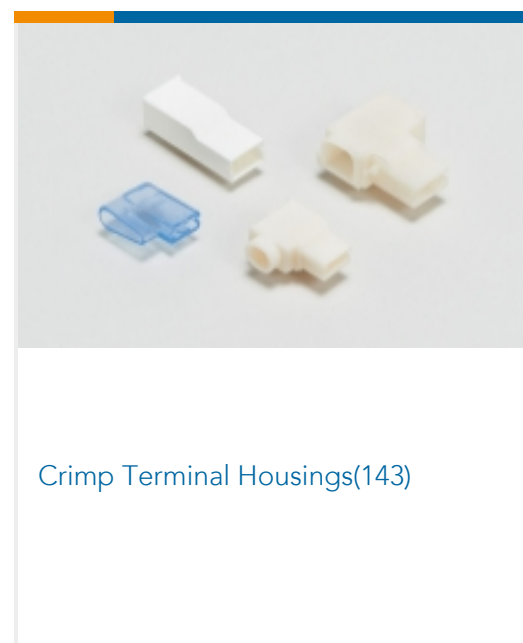
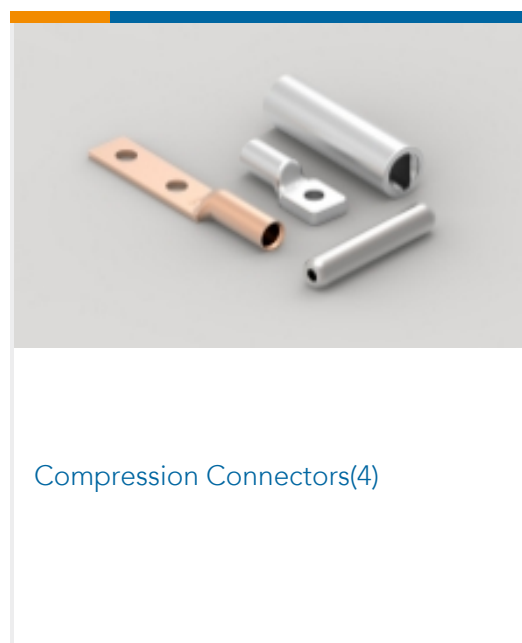

Customers Also Bought

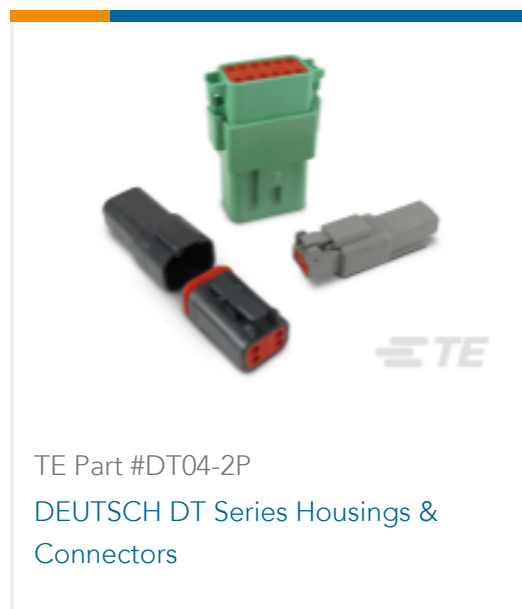

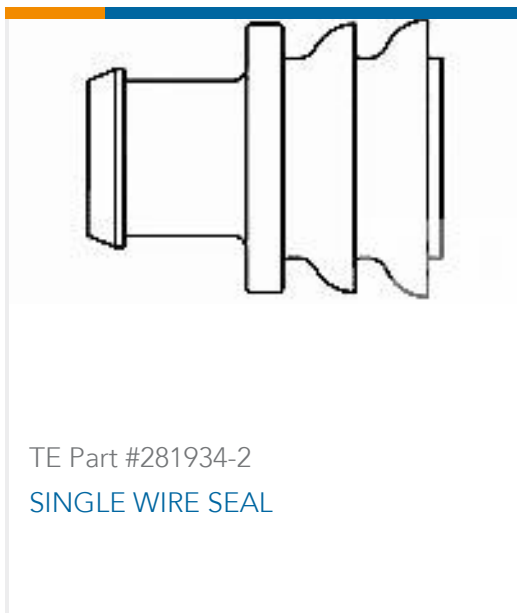

Documents

CAD Files

3D PDF

3D

Customer View Model

[ENG_CVM_CVM_521358-1_V_c-521358-1-v.2d_dxf.zip](#)

English

Customer View Model

[ENG_CVM_CVM_521358-1_V_c-521358-1-v.3d_igs.zip](#)

English

Customer View Model

[ENG_CVM_CVM_521358-1_V_c-521358-1-v.3d_stp.zip](#)

English

By downloading the CAD file I accept and agree to the [Terms and Conditions](#) of use.

Product Environmental Compliance

TE Material Declaration

English