

520947-1 ✓ ACTIVE

FASTIN-FASTON | FASTIN-FASTON 250, FASTIN-FASTON 375

TE Internal #: 520947-1

Crimp Terminal Housings, Receptacle, Receptacle, 4 Position, Straight, Natural, Polyester, Contact Mating Retention, FASTIN-FASTON 375

[View on TE.com >](#)



Terminals & Splices > Terminal Housings, Insulation Sleeves & Blocks > Crimp Terminal Housings

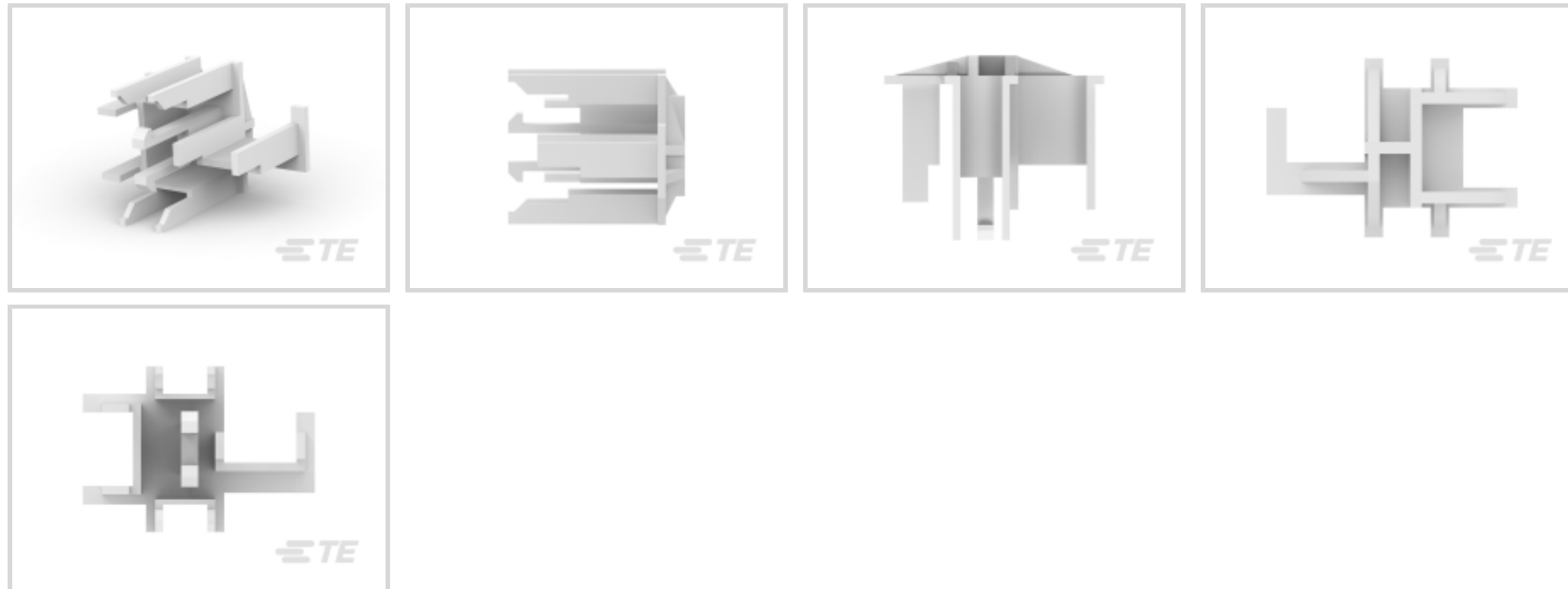

Terminal Type: **Receptacle**

Housing Type: **Receptacle**

Number of Positions: **4**

Terminal Orientation: **Straight**

Primary Product Color: **Natural**

Features

Product Type Features

Product Type	Terminal Housing
Sealable	No
Housing Type	Receptacle
Insulated	No

Configuration Features

Number of Positions	4
---------------------	---

Body Features

Primary Product Color	Natural
-----------------------	---------

Contact Features

Terminal Type	Receptacle
Terminal Orientation	Straight
Contact Mating Retention	With

Mechanical Attachment



Mating Alignment	With
Crimp Terminal Housing Mounting Style	Cable Mount (Free-Hanging)

Housing Features

Housing Material	Polyester
------------------	-----------

Usage Conditions

Operating Temperature Range	-40 – 105 °C[-40 – 221 °F]
-----------------------------	----------------------------

Packaging Features

Packaging Method	Carton
------------------	--------

Product Compliance

[For compliance documentation, visit the product page on TE.com>](#)

EU RoHS Directive 2011/65/EU	Compliant
EU ELV Directive 2000/53/EC	Compliant
China RoHS 2 Directive MIIT Order No 32, 2016	No Restricted Materials Above Threshold
EU REACH Regulation (EC) No. 1907/2006	Current ECHA Candidate List: JUNE 2022 (224) Candidate List Declared Against: JUL 2021 (219) SVHC > Threshold: Not Yet Reviewed
Halogen Content	Low Halogen - Br, Cl, F, I < 900 ppm per homogenous material. Also BFR/CFR/PVC Free
Solder Process Capability	Not applicable for solder process capability

Product Compliance Disclaimer

This information is provided based on reasonable inquiry of our suppliers and represents our current actual knowledge based on the information they provided. This information is subject to change. The part numbers that TE has identified as EU RoHS compliant have a maximum concentration of 0.1% by weight in homogenous materials for lead, hexavalent chromium, mercury, PBB, PBDE, DBP, BBP, DEHP, DIBP, and 0.01% for cadmium, or qualify for an exemption to these limits as defined in the Annexes of Directive 2011/65/EU (RoHS2). Finished electrical and electronic equipment products will be CE marked as required by Directive 2011/65/EU. Components may not be CE marked. Additionally, the part numbers that TE has identified as EU ELV compliant have a maximum concentration of 0.1% by weight in homogenous materials for lead, hexavalent chromium, and mercury, and 0.01% for cadmium, or qualify for an exemption to these limits as defined in the Annexes of Directive 2000/53/EC (ELV). Regarding the REACH Regulation, the information TE provides on SVHC in articles for this part number is based on the latest European Chemicals Agency (ECHA) 'Guidance on requirements for substances in articles' posted at this URL: <https://echa.europa.eu/guidance-documents/guidance-on-reach>

Compatible Parts



Also in the Series | **FASTIN-FASTON 250**

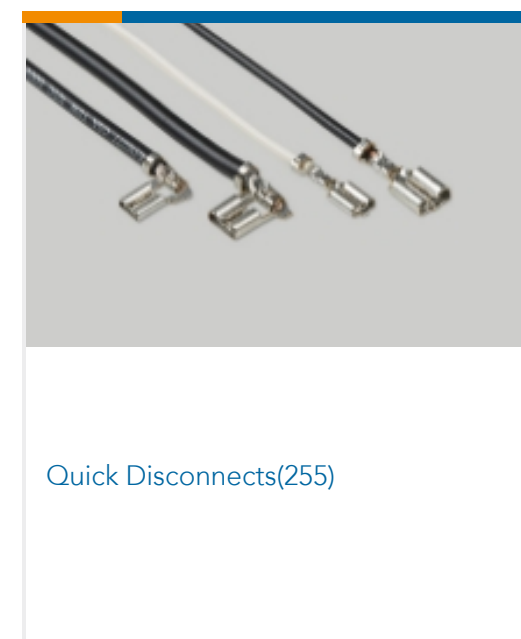
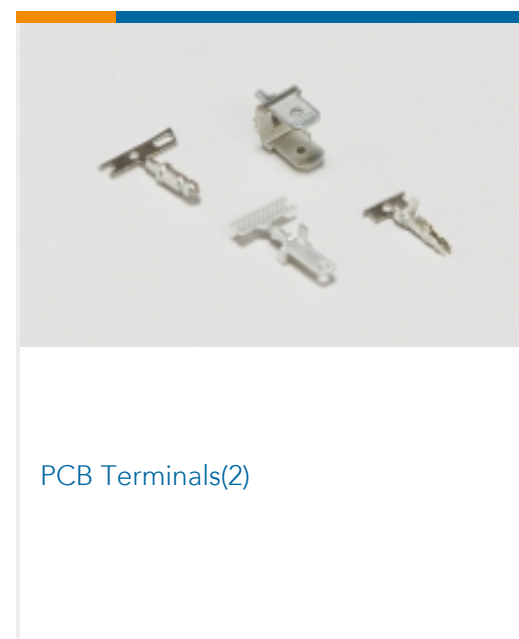
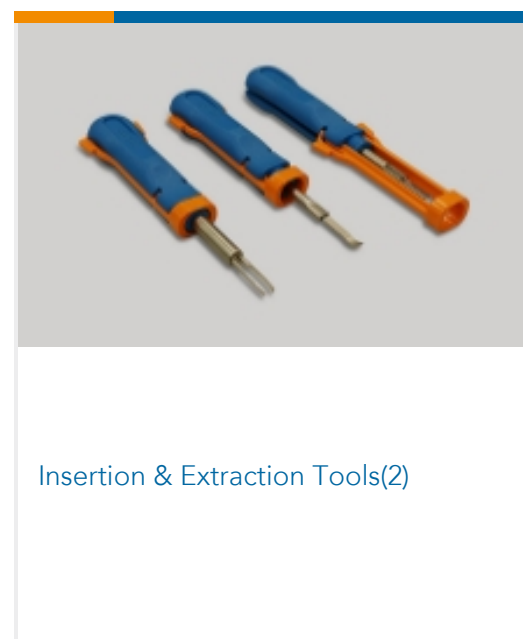
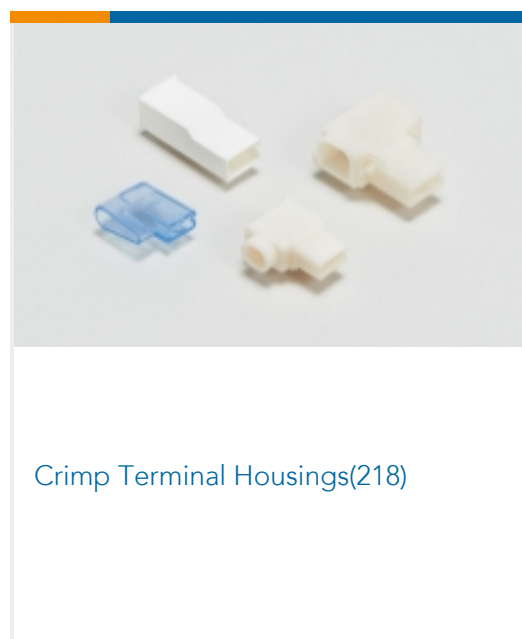

Also in the Series | **FASTIN-FASTON 375**



Crimp Terminal Housings(9)



Insertion & Extraction Tools(1)

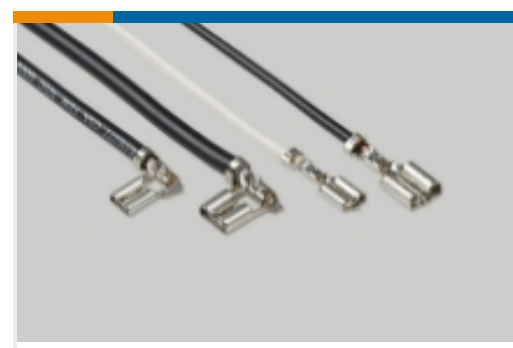

Quick Disconnects(20)

Customers Also Bought

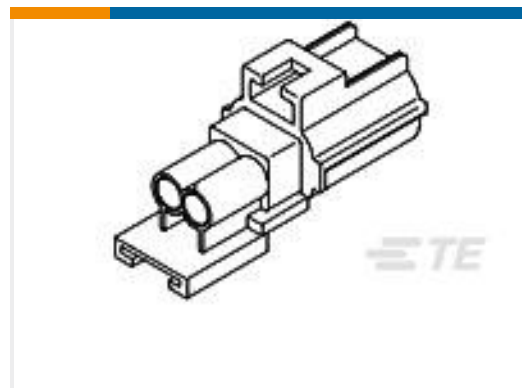
TE Part #184152-1
2 POS. END CAP HSG., KEY BTE Part #2837509-2
OCEAN-2.0-APPLICATOR-S-120F2320ATE Part #2837671-2
OCEAN-2.0-APPLICATOR-S-120F2500TE Part #2837787-2
OCEAN-2.0-APPLICATOR-S-079F2500TE Part #1488208-8
0.64MM PIN CONTACT, AU, 22 AWG

Documents

Product Drawings

[FF 250/375 REC HSG 4P SECONDARY LOCK](#)

English

CAD Files

[3D PDF](#)

3D

Customer View Model

[ENG_CVM_CVM_520947-1_E_c-520947-1-e.2d_dxf.zip](#)

English

Customer View Model

[ENG_CVM_CVM_520947-1_E_c-520947-1-e.3d_igs.zip](#)

English

Customer View Model

[ENG_CVM_CVM_520947-1_E_c-520947-1-e.3d_stp.zip](#)

English

By downloading the CAD file I accept and agree to the [Terms and Conditions](#) of use.



Datasheets & Catalog Pages

White Paper: Nylon Discoloration

English

Product Specifications

Application Specification

English