

5100145-1 ✓ ACTIVE

Z-PACK | Z-PACK 2mm HM

TE Internal #: 5100145-1

Hard Metric Backplane Connectors, PCB Mount Receptacle,  $\leq 1$  Gb/s, 25 Column, 5 Row, Mezzanine, Board-to-Board, 125 Position, Z-PACK 2mm HM

[View on TE.com >](#)



[Connectors](#) > [PCB Connectors](#) > [Backplane Connectors](#) > [Hard Metric Connectors](#) >

HM Receptacle Connector: Traditional Backplane, Coplanar, 2mm



PCB Connector Assembly Type: **PCB Mount Receptacle**

Data Rate:  $\leq 1$  Gb/s

Number of Columns: **25**

Number of Rows: **5**

Backplane Architecture: **Mezzanine**

[All HM Receptacle Connector: Traditional Backplane, Coplanar, 2mm \(48\)](#)

## Features

### Product Type Features

Backplane Interface Type	2mm HM
PCB Connector Assembly Type	PCB Mount Receptacle
Connector System	Board-to-Board
Sealable	No
Connector & Contact Terminates To	Printed Circuit Board

### Configuration Features

Rows Loaded	A, B, C, D, E
Number of Columns	25
Number of Rows	5
Backplane Architecture	Mezzanine
Number of Positions	125
PCB Mount Orientation	Right Angle



### Signal Characteristics

Crosstalk Version	Standard
Data Rate	≤1 Gb/s

### Contact Features

Feedthrough Post Length	3.7 mm
Contact Type	Socket
Contact Underplating Material	Nickel
PCB Contact Termination Area Plating Material	Tin
Contact Base Material	Phosphor Bronze
CompactPCI Designation	None
Contact Mating Area Plating Material	Performance Based
Contact Mating Area Plating Material Thickness	1.27 μm[50 μin]
Contact Current Rating (Max)	1.5 A

### Mechanical Attachment

Connector Mounting Type	Board Mount
-------------------------	-------------

### Housing Features

Housing Material	Polyester - GF
Centerline (Pitch)	2 mm[.078 in]
Housing Color	Gray

### Dimensions

Backplane Module Length	50 mm
-------------------------	-------

### Usage Conditions

Operating Temperature Range	-55 – 125 °C[-67 – 257 °F]
-----------------------------	----------------------------

### Operation/Application

Shielded	No
Circuit Application	Power & Signal

### Industry Standards

UL Flammability Rating	UL 94V-0
AdvancedTCA Specified Product	No

### Packaging Features

Packaging Quantity	11
--------------------	----



Packaging Method

Tube

**Other**

Comment	Connector conforms to all testing according to IEC 61076-4-101, Performance Level 2.
---------	--

**Product Compliance**

[For compliance documentation, visit the product page on TE.com>](#)

EU RoHS Directive 2011/65/EU	Compliant
EU ELV Directive 2000/53/EC	Compliant
China RoHS 2 Directive MIIT Order No 32, 2016	No Restricted Materials Above Threshold
EU REACH Regulation (EC) No. 1907/2006	Current ECHA Candidate List: JUNE 2022 (224) Candidate List Declared Against: JAN 2022 (223) SVHC > Threshold: Not Yet Reviewed
Halogen Content	Not Low Halogen - contains Br or Cl > 900 ppm.
Solder Process Capability	Not applicable for solder process capability

Product Compliance Disclaimer

This information is provided based on reasonable inquiry of our suppliers and represents our current actual knowledge based on the information they provided. This information is subject to change. The part numbers that TE has identified as EU RoHS compliant have a maximum concentration of 0.1% by weight in homogenous materials for lead, hexavalent chromium, mercury, PBB, PBDE, DBP, BBP, DEHP, DIBP, and 0.01% for cadmium, or qualify for an exemption to these limits as defined in the Annexes of Directive 2011/65/EU (RoHS2). Finished electrical and electronic equipment products will be CE marked as required by Directive 2011/65/EU. Components may not be CE marked. Additionally, the part numbers that TE has identified as EU ELV compliant have a maximum concentration of 0.1% by weight in homogenous materials for lead, hexavalent chromium, and mercury, and 0.01% for cadmium, or qualify for an exemption to these limits as defined in the Annexes of Directive 2000/53/EC (ELV). Regarding the REACH Regulation, the information TE provides on SVHC in articles for this part number is based on the latest European Chemicals Agency (ECHA) 'Guidance on requirements for substances in articles' posted at this URL: <https://echa.europa.eu/guidance-documents/guidance-on-reach>

**Compatible Parts**



TE Part # CAT-472-Z12  
Hard Metric Male Connector:  
Traditional Backplane, Mezzanine,  
2mm



TE Part # 5106014-1  
Z-PACK/B RAMH.125P.



TE Part # 106138-2  
Z-PACK/B SHRD.125P.

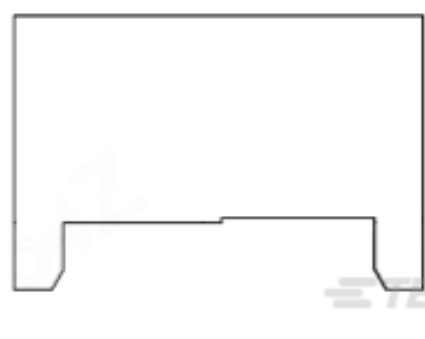

TE Part # 122559-1  
SEATING TOOL 2MM HM 7 ROW

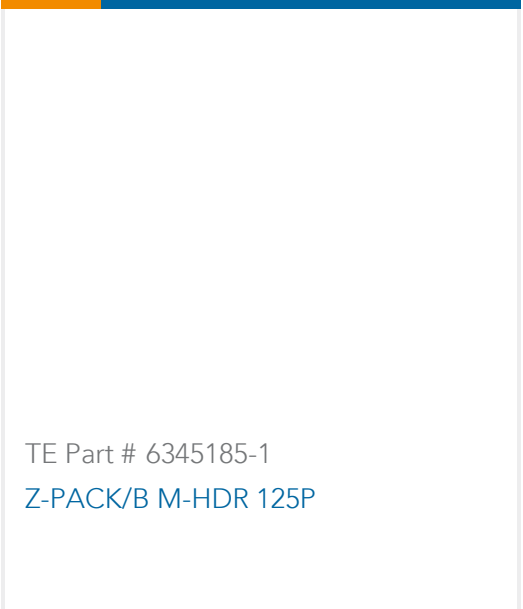
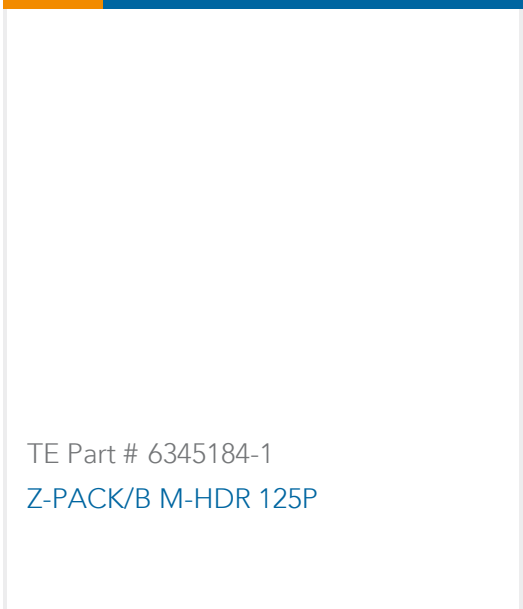
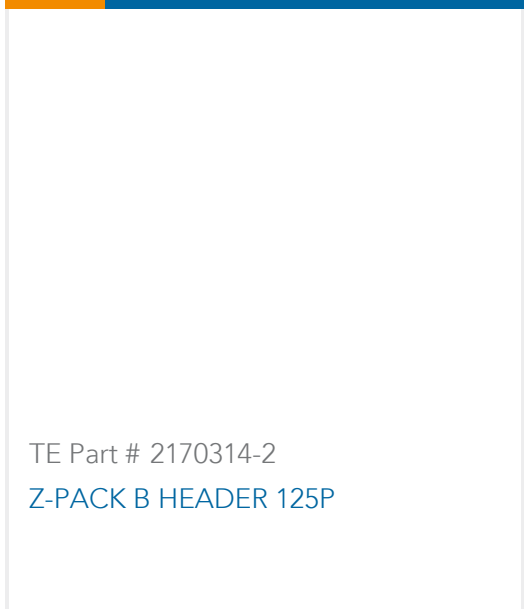
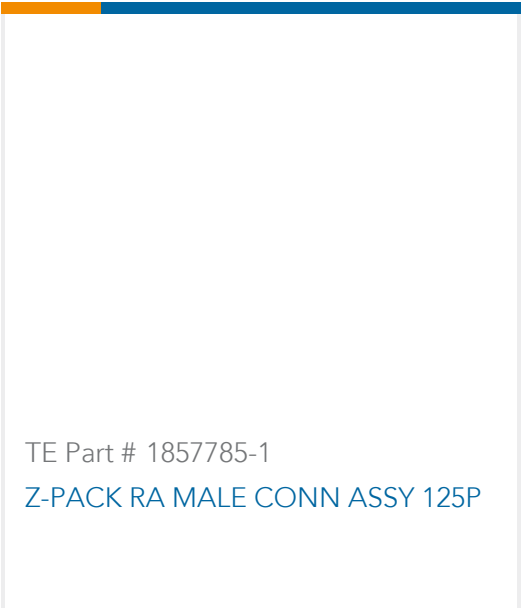
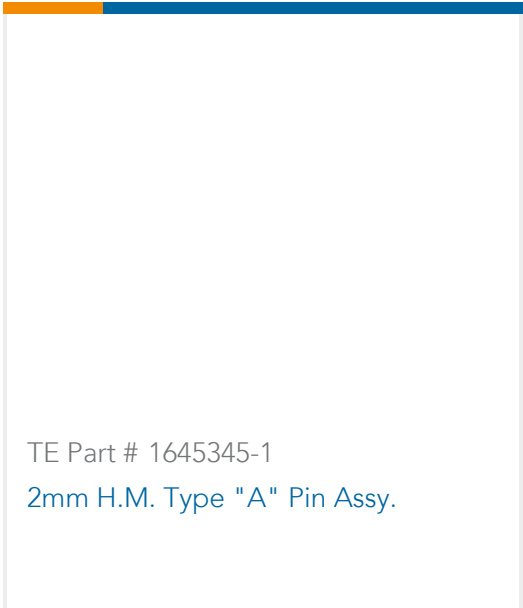
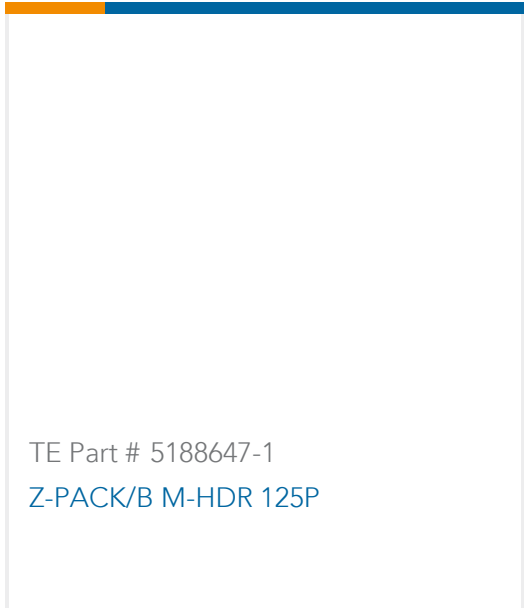

## Also in the Series | Z-PACK 2mm HM

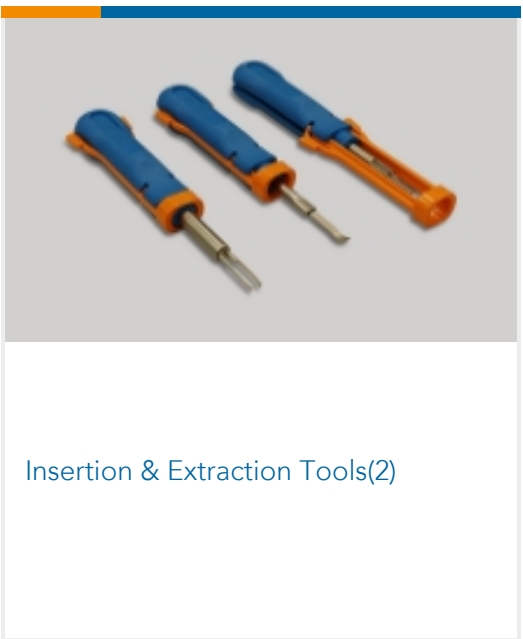
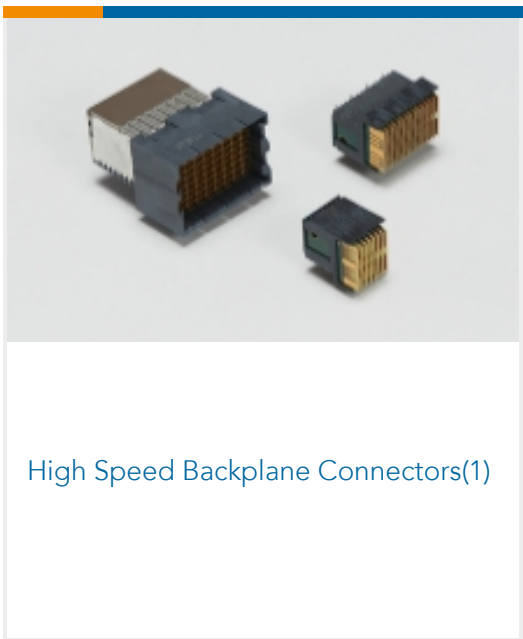
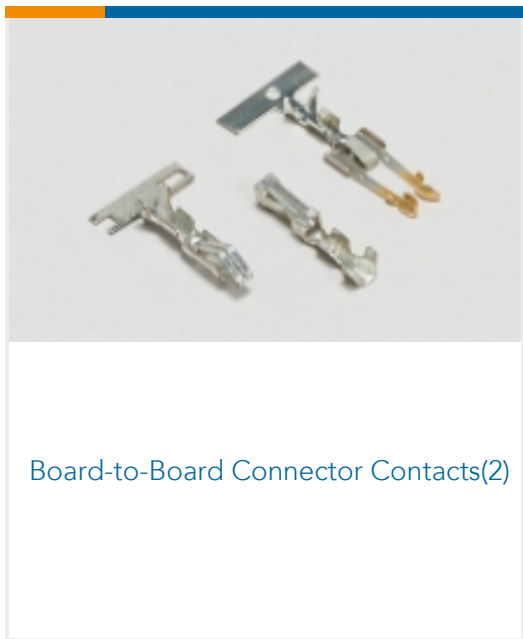
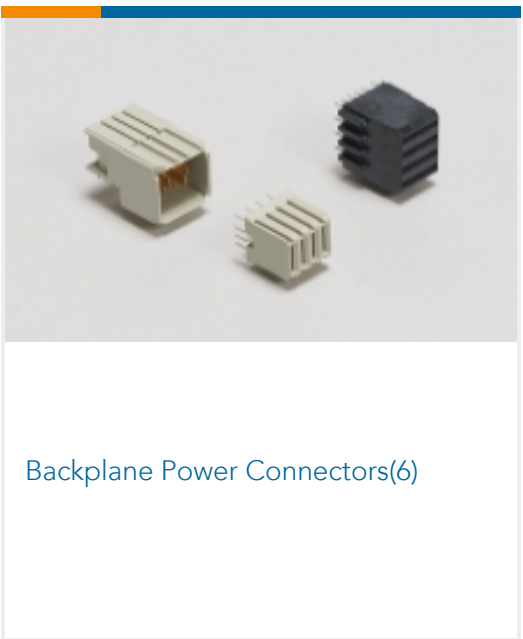
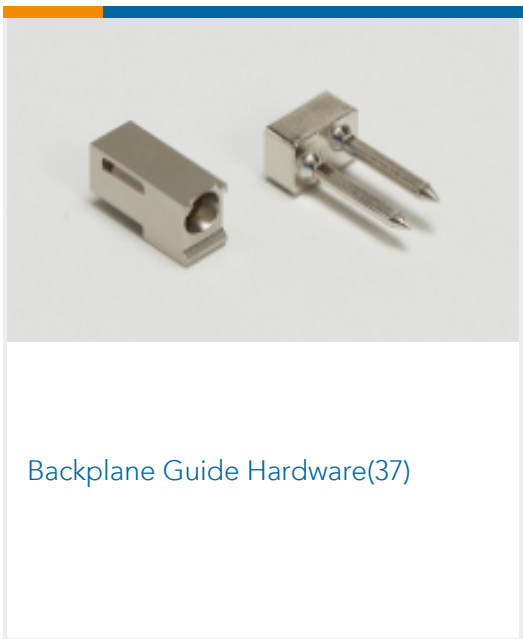
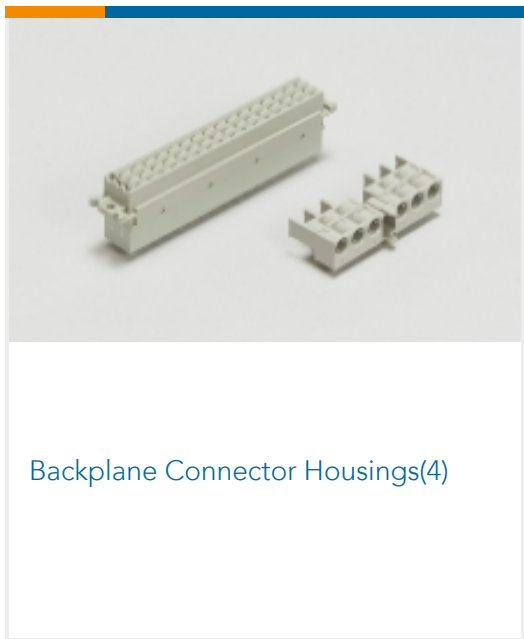
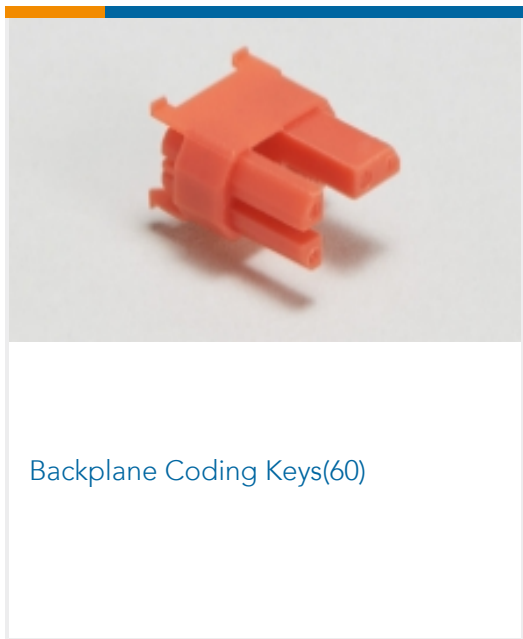



Rectangular Power Connectors(87)

## Customers Also Bought



TE Part #5646347-1  
Hard Metric Male Connector:  
Traditional Backplane, Mezzanine,  
2mm



TE Part #5352069-1  
Z-PACK/B25 RAF 125P

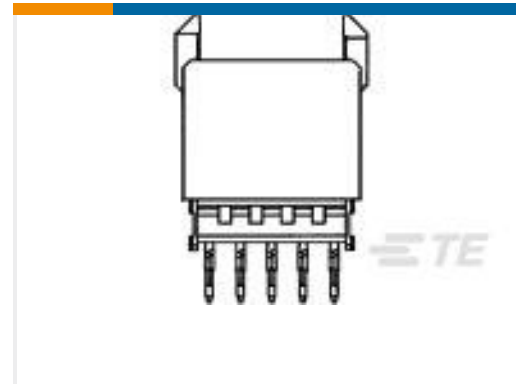

TE Part #5106774-1  
Z-PACK/B25 VF 125P



TE Part #6469083-1  
HMZD 3PAIR, HDR ASSY, 25MM MOD



TE Part #1-316132-2  
DYNAMIC D-3200 HDR ASSY 5P V



TE Part #5646956-2  
UPM PIN ASSEMBLY, SEQUENCED

## Documents

### Product Drawings

#### Z-PACK/B25 RAF 125P

English

### CAD Files

#### 3D PDF

English

#### Customer View Model

[ENG\\_CVM\\_5100145-1\\_B.2d\\_dxf.zip](#)

English

#### Customer View Model

[ENG\\_CVM\\_5100145-1\\_B.3d\\_igs.zip](#)

English

#### Customer View Model

[ENG\\_CVM\\_5100145-1\\_B.3d\\_stp.zip](#)

English

By downloading the CAD file I accept and agree to the [Terms and Conditions](#) of use.



---

**Product Specifications**

**Application Specification**

English

---

**Product Environmental Compliance**

**MD\_5100145-1\_06122018440\_dmtec**

English

**MD\_5100145-1\_06122018440\_dmtec**

English