

PLEASE CHECK WWW.MOLEX.COM FOR LATEST PART INFORMATION

Part Number: [5051520500](#)
Status: **Active**
Overview: [DuraClik Connector System](#)
Description: [DuraClik Wire-to-Board 2-Way Terminal Position Assurance \(TPA\) Retainer, 5 Circuits](#)

Documents:

3D Model	Application Specification AS-505151-001-001 (PDF)
Drawing (PDF)	Application Specification AS-505151-002-001 (PDF)
3D Model (PDF)	Packaging Specification SPK-505152-001-001 (PDF)
Product Specification 5051510002-000 (PDF)	Datasheet (PDF)
Product Specification PS-505151-001-001 (PDF)	RoHS Certificate of Compliance (PDF)

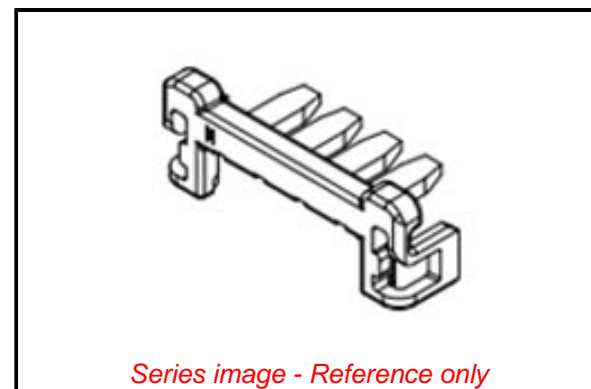

General

Product Family	Accessories
Series	505152
Application	Automotive
Component Type	Terminal Position Assurance
Overview	DuraClik Connector System
Product Name	DuraClik
UPC	887191735177

Physical

Circuits (Loaded)	5
Circuits (maximum)	5
Lock to Mating Part	Yes
Material - Resin	PBT
Net Weight	67.300/mg
Number of Rows	1
Packaging Type	Bag
Polarized to Mating Part	Yes
Temperature Range - Operating	-40° to +125°C
Termination Interface: Style	Crimp or Compression

Electrical

Current - Maximum per Contact	3.0A
-------------------------------	------

Material Info

Reference - Drawing Numbers

Application Specification	AS-505151-001-001, AS-505151-002-001
Packaging Specification	SPK-505152-001-001
Product Specification	5051510002-000, PS-505151-001-001
Sales Drawing	SD-505152-001

EU ELV

Compliant

EU RoHS

Compliant

REACH SVHC

Not Contained Per -
D(2020)4578-DC (25
June 2020)

Halogen-Free

Status

Not Low-Halogen

For more information, please visit [Contact US](#)

China ROHS

ELV

RoHS Phthalates

China RoHS

Green Image

Compliant

Not Contained

Search Parts in this Series

[505152](#) Series

Use With

[505151](#) DuraClik TPA Wire-to-Board Housing, [505153](#) DuraClik TPA Wire-to-Board Terminal