

**PLEASE CHECK WWW.MOLEX.COM FOR LATEST PART INFORMATION**

**Part Number:** [5041931100](#)  
**Status:** **Active**  
**Overview:** [Micro-Lock™ Connectors](#)  
**Description:** [Micro-Lock 1.25mm Pitch Single-Row Crimp Housing, White, 11 Circuits, 5041931100](#)

**Documents:**

<a href="#">3D Model</a>	<a href="#">Application Specification AS-504193-002-001 (PDF)</a>
<a href="#">Drawing (PDF)</a>	<a href="#">Packaging Specification SPK-504193-001-001 (PDF)</a>
<a href="#">Product Specification PS-504193-001-001 (PDF)</a>	<a href="#">RoHS Certificate of Compliance (PDF)</a>
<a href="#">Application Specification AS-504193-001-001 (PDF)</a>	

**General**

Product Family	Crimp Housings
Series	<a href="#">504193</a>
Application	Wire-to-Board
Overview	<a href="#">Micro-Lock™ Connectors</a>
Product Name	Micro-Lock
UPC	887191164984

**Physical**

Circuits (maximum)	11
Color - Resin	White
Gender	Receptacle
Glow-Wire Capable	No
Lock to Mating Part	Yes
Material - Resin	Polyester
Net Weight	192.447/mg
Number of Rows	1
Packaging Type	Tray
Panel Mount	No
Pitch - Mating Interface	1.25mm
Pitch - Termination Interface	1.25mm
Polarized to Mating Part	Yes
Temperature Range - Operating	-25° to +85°C

**Electrical**

Current - Maximum per Contact	1.5A
-------------------------------	------

**Material Info**

**Reference - Drawing Numbers**

Application Specification	AS-504193-001-001, AS-504193-002-001
Packaging Specification	SPK-504193-001-001
Product Specification	PS-504193-001-001
Sales Drawing	SD-504193-001

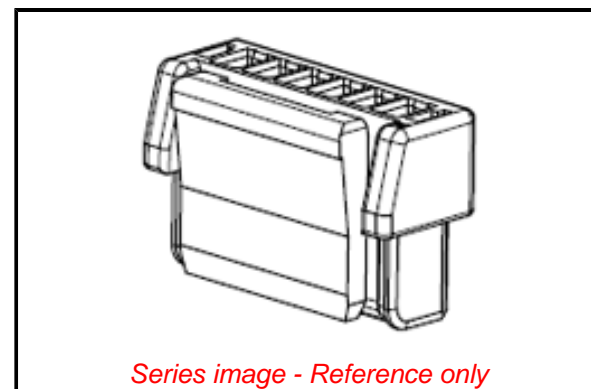

*Series image - Reference only*

**EU ELV**

**Not Relevant**

**EU RoHS**

**Compliant**

**REACH SVHC**

Not Contained Per -  
ED/71/2019 (16 July  
2019)

**Halogen-Free**

**Status**

**Not Low-Halogen**

For more information, please visit [Contact US](#)

China ROHS

ELV

RoHS Phthalates

**China RoHS**

Green Image

Not Relevant

Not Contained

**Search Parts in this Series**

[504193 Series](#)

**Mates With**

[504194](#) Micro-Lock 1.25mm Pitch Vertical Header, [504195](#) Micro-Lock 1.25mm Pitch Right Angle Header

**Use With**

Micro-Lock Wire-to-Board Crimp Terminal [5041851000](#)