

10 9 8 7 6 5 4 3 2 1

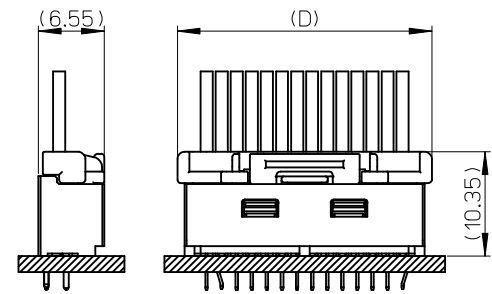

嵌合図 (SCALE 2:1)
MATED CONNECTORS (SCALE 2:1)

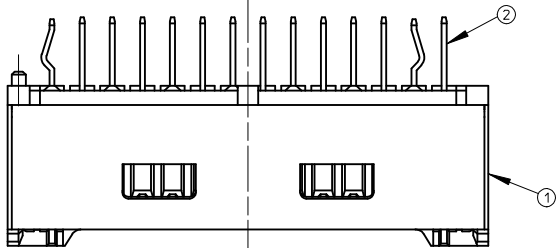
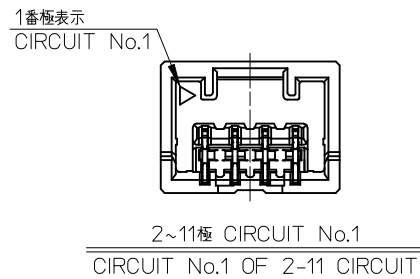
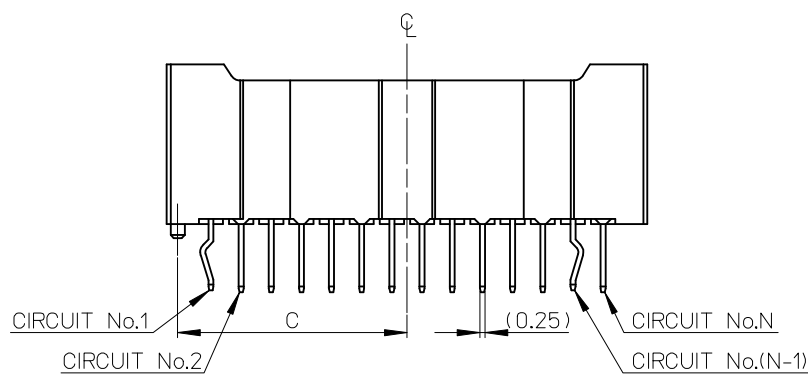
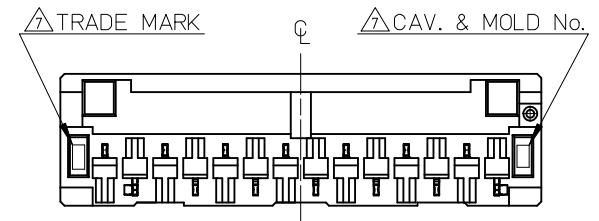
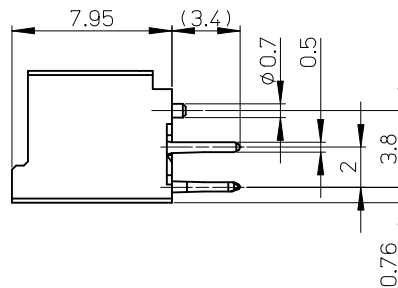
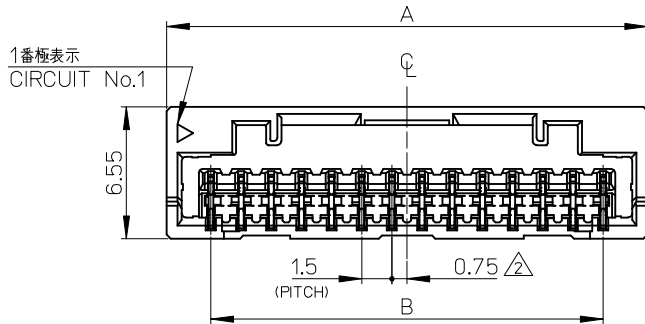

26.8	12.15	21	25.4	503159-15**	15
25.3	11.4	19.5	23.9	503159-14**	14
23.8	10.65	18	22.4	503159-13**	13
22.3	9.9	16.5	20.9	503159-12**	12
20.8	9.15	15	19.4	503159-11**	11
19.3	8.4	13.5	17.9	503159-10**	10
17.8	7.65	12	16.4	503159-09**	9
16.3	6.9	10.5	14.9	503159-08**	8
14.8	6.15	9	13.4	503159-07**	7
13.3	5.4	7.5	11.9	503159-06**	6
11.8	4.65	6	10.4	503159-05**	5
10.3	3.9	4.5	8.9	503159-04**	4
8.8	3.15	3	7.4	503159-03**	3
7.3	2.4	1.5	5.9	503159-02**	2
D	C	B	A	TRAY PACKAGE	CIRCUIT
				ORDER No.	

No.	部品 PART	材料 MATERIAL
①	ハウジング HOUSING	ポリアミド(PA) UL94V-0 POLYAMIDE UL94V-0 色:注記 5. 参照 COLOR:SEE NOTES 5.
②	ターミナル TERMINAL	銅合金 COPPER ALLOY 錫めっき(1.0μm以上) TIN PLATING OVERALL SURFACES (1.0 MICROMETER MINIMUM) 下地:ニッケルめっき(1.0μm以上) UNDER PLATE:NICKEL OVERALL (1.0 MICROMETER MINIMUM)

REVISED EC NO: J2014-1798 DRWN:YAJI MA01 2014/06/10 CHKD:KASAKAWA 2014/06/11 APPR:NUKITA 2014/06/12	DESCRIPTION REV	GENERAL TOLERANCES (UNLESS SPECIFIED)		DIMENSION STYLE MM ONLY		SCALE 4:1		DESIGN UNITS METRIC		THIRD ANGLE PROJECTION			
		10 UNDER	±0.2	DRAWN BY SKUROSE DATE 2008/06/06		TITLE		1.5 W/B CONN. SINGLE DIP ST REC. ASS'Y 2-15CKT					
		10 OVER 30 UNDER	±0.25	CHECKED BY KASAKAWA DATE 2008/06/06		DOCUMENT NO.						SHEET NO.	
		30 OVER	±0.3	APPROVED BY SICHIKAWA DATE 2008/06/06		SD-503159-001						1 OF 3	
ANGULAR ±3 °		MATERIAL NO.		SEE TABLE									
DRAFT WHERE APPLICABLE MUST REMAIN WITHIN DIMENSIONS				SIZE A3		THIS DRAWING CONTAINS INFORMATION THAT IS PROPRIETARY TO MOLEX INCORPORATED AND SHOULD NOT BE USED WITHOUT WRITTEN PERMISSION							

9 8 7 6 5 4 3 2

10 9 8 7 6 5 4 3 2 1

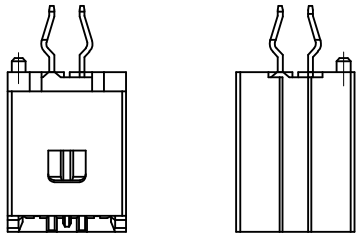

2~3 極形状 (ロック面及び反ロック面)

FIGURE OF 2-3 CIRCUIT (LOOK SIDE AND UN-LOCK SIDE)

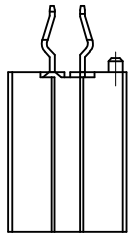

4~5 極形状 (ロック面及び反ロック面)

FIGURE OF 4-5 CIRCUIT (LOOK SIDE AND UN-LOCK SIDE)

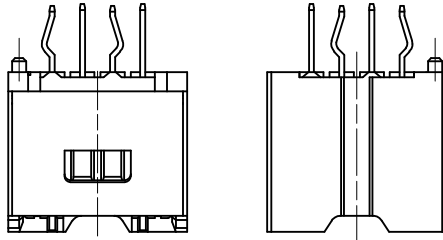

6~7 極形状 (ロック面及び反ロック面)

FIGURE OF 6-7 CIRCUIT (LOOK SIDE AND UN-LOCK SIDE)

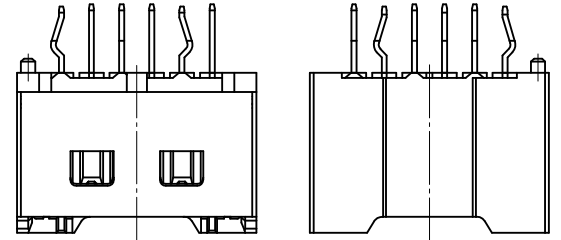

8~10 極形状 (反ロック面)

FIGURE OF 8-10 CIRCUIT (UN-LOCK SIDE)

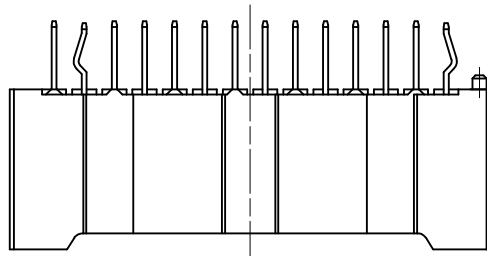

11~15 極形状 (反ロック面)

FIGURE OF 11-15 CIRCUIT (UN-LOCK SIDE)

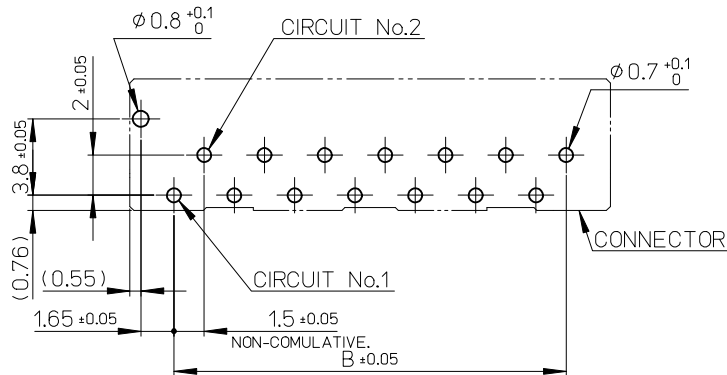

基板取付穴推奨寸法 (マウント面)
 RECOMMENDED P.C.BOARD
 HOLE DIMENSION
 (MOUNTING SIDE)
 $(t=1.6)$

REVISED EC NO: J2014-1798 DRWN:YAJI MA01 2014/06/10 CHKD:KASAKAWA 2014/06/11 APPR:NUKITA 2014/06/12 J	DESCRIPTION GENERAL TOLERANCES (UNLESS SPECIFIED) 10 UNDER ± 0.2 10 OVER 30 UNDER ± 0.25 30 OVER ± 0.3 ANGULAR $\pm 3^\circ$ DRAFT WHERE APPLICABLE MUST REMAIN WITHIN DIMENSIONS	DIMENSION STYLE MM ONLY	SCALE 4:1	DESIGN UNITS METRIC	THIRD ANGLE PROJECTION	
		DRAWN BY SKUROSE	DATE 2008/06/06	TITLE 1.5 W/B CONN. SINGLE DIP ST REC. ASS'Y 2-15CKT		
		CHECKED BY KASAKAWA	DATE 2008/06/06	APPROVED BY SICHIKAWA		
		DATE 2008/06/06	MATERIAL NO. SEE TABLE	DOCUMENT NO. SD-503159-001	SHEET NO. 2 OF 3	

THIS DRAWING CONTAINS INFORMATION THAT IS PROPRIETARY TO MOLEX
 INCORPORATED AND SHOULD NOT BE USED WITHOUT WRITTEN PERMISSION

9 8 7 6 5 4 3 2

NOTES

1. 嵌合相手: 502578 シリーズ
MATE WITH : 502578 SERIES.
- △ 極数/2=偶数に適用
APPLY FOR CIRCUIT SIZE/2=EVEN.
3. 端子テール部に錫めっきを使用している為、外観に摺動痕が付く場合があります。
THE WOUND OF FRICTION MIGHT ADHERE TO EXTERNALS BECAUSE THE TIN PLATING IS USED FOR THE TAIL.

4. 製品番号
MATERIAL No.
503159-***

極数
CIRCUIT SIZE

ボス、色
BOSS, COLOR

ボス有り		CIRCUIT	No.	COLOR
02~15	0	0	ベージュ	BEIGE
		1	黒	BLACK
		2	赤	RED
		3	黄	YELLOW
		4	青	BLUE
		5	桃	PINK
		6	緑	GREEN
		7	茶	BROWN
		8	橙	ORANGE
02~05	2	1	灰	GRAY
		4	水	PALE BLUE
		6	黄緑	YELLOWISH GREEN
02	2	3	蛍光黄	FLUORESCENCE YELLOW

5. 本製品のプラスチック部に黒点・白点等が確認される場合や色合いが異なる場合がありますが、製品性能に影響はありません。
THERE IS NO INFLUENCE IN THE PRODUCT PERFORMANCE THOUGH THE BLACK AND WHITE SPOT ETC. MIGHT BE CONFIRMED TO THE PLASTIC PART OF THIS PRODUCT AND THE SHADE MIGHT BE DIFFERENT.

6. ELV及びRoHS適合品
ELV AND RoHS COMPLIANT

△ トレードマーク: Mプラス1~2文字のアルファベットにて構成。(例 MXJ)
但し"J"はJAPANを示す。
キャビティ番号: 1桁~2桁の数字で構成。
金型番号: アルファベット1文字にて構成。
TRADE MARK: FORMED BY M AND 1~2 MORE LETTER OF ALPHABET (e.g. MXJ), BUT "J" MEANS JAPAN.
CAVITY NO.: FORMED BY 1 DIGIT TO 2 DIGIT NUMBERS.
MOLD NO.: FORMED BY 1 LETTER OF ALPHABET.

REVISED EC No: J2014-4798 DRWN:TYAJIMA01 2014/06/10 CHKD:KASAKAWA 2014/06/11 APPR:NUKITA 2014/06/12	DESCRIPTION REV	GENERAL TOLERANCES (UNLESS SPECIFIED)		DIMENSION STYLE MM ONLY		SCALE 4:1	DESIGN UNITS METRIC	THIRD ANGLE PROJECTION		
		10 UNDER	±0.2	DRAWN BY TYAJIMA01	DATE 2014/06/10	TITLE 1.5 W/B CONN. SINGLE DIP ST REC. ASS'Y 2-15CKT				
		10 OVER 30 UNDER	±0.25	CHECKED BY KASAKAWA	DATE 2014/06/11					
		30 OVER	±0.3	APPROVED BY NUKITA	DATE 2014/06/12					
ANGULAR ±3 ° DRAFT WHERE APPLICABLE MUST REMAIN WITHIN DIMENSIONS		MATERIAL NO. SEE TABLE		DOCUMENT NO. SD-503159-001		SHEET NO. 3 OF 3				
SIZE A3		THIS DRAWING CONTAINS INFORMATION THAT IS PROPRIETARY TO MOLEX INCORPORATED AND SHOULD NOT BE USED WITHOUT WRITTEN PERMISSION								