

**PLEASE CHECK WWW.MOLEX.COM FOR LATEST PART INFORMATION**

**Part Number:** [5051521300](#)  
**Status:** **Active**  
**Overview:** [DuraClik Connector System](#)  
**Description:** [DuraClik Wire-to-Board 2-Way Terminal Position Assurance \(TPA\) Retainer, 13 Circuits](#)

**Documents:**

<a href="#">3D Model</a>	<a href="#">Application Specification AS-505151-001-001 (PDF)</a>
<a href="#">3D Model (PDF)</a>	<a href="#">Application Specification AS-505151-002-001 (PDF)</a>
<a href="#">Drawing (PDF)</a>	<a href="#">Packaging Specification SPK-505152-001-001 (PDF)</a>
<a href="#">Product Specification 5051510002-000 (PDF)</a>	<a href="#">Datasheet (PDF)</a>
<a href="#">Product Specification PS-505151-001-001 (PDF)</a>	<a href="#">RoHS Certificate of Compliance (PDF)</a>

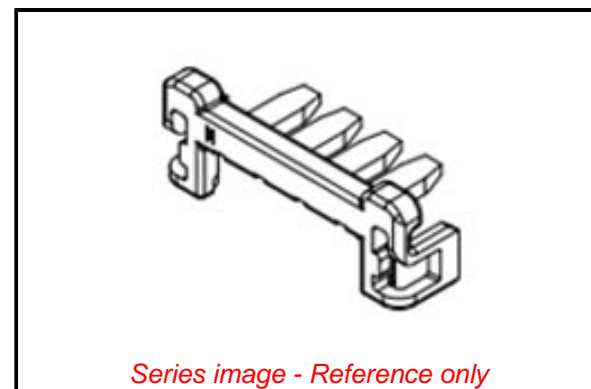

**General**

Product Family	Accessories
Series	<a href="#">505152</a>
Application	Automotive
Component Type	Terminal Position Assurance
Overview	<a href="#">DuraClik Connector System</a>
Product Name	DuraClik
UPC	887191735252

**Physical**

Circuits (Loaded)	13
Circuits (maximum)	13
Lock to Mating Part	Yes
Material - Resin	PBT
Net Weight	154.200/mg
Number of Rows	1
Packaging Type	Bag
Polarized to Mating Part	Yes
Temperature Range - Operating	-40° to +125°C
Termination Interface: Style	Crimp or Compression

**Electrical**

Current - Maximum per Contact	3.0A
-------------------------------	------

**Material Info**

**Reference - Drawing Numbers**

Application Specification	AS-505151-001-001, AS-505151-002-001
Packaging Specification	SPK-505152-001-001
Product Specification	5051510002-000, PS-505151-001-001
Sales Drawing	SD-505152-001

**EU ELV**

**Compliant**

**EU RoHS**

**Compliant**

**REACH SVHC**

Not Contained Per -  
D(2020)4578-DC (25  
June 2020)

**Halogen-Free**

**Status**

**Not Low-Halogen**

For more information, please visit [Contact US](#)

China ROHS

ELV

RoHS Phthalates

**China RoHS**

Green Image

Compliant

Not Contained

**Search Parts in this Series**

[505152](#) Series

**Use With**

[505151](#) DuraClik TPA Wire-to-Board Housing, [505153](#) DuraClik TPA Wire-to-Board Terminal