

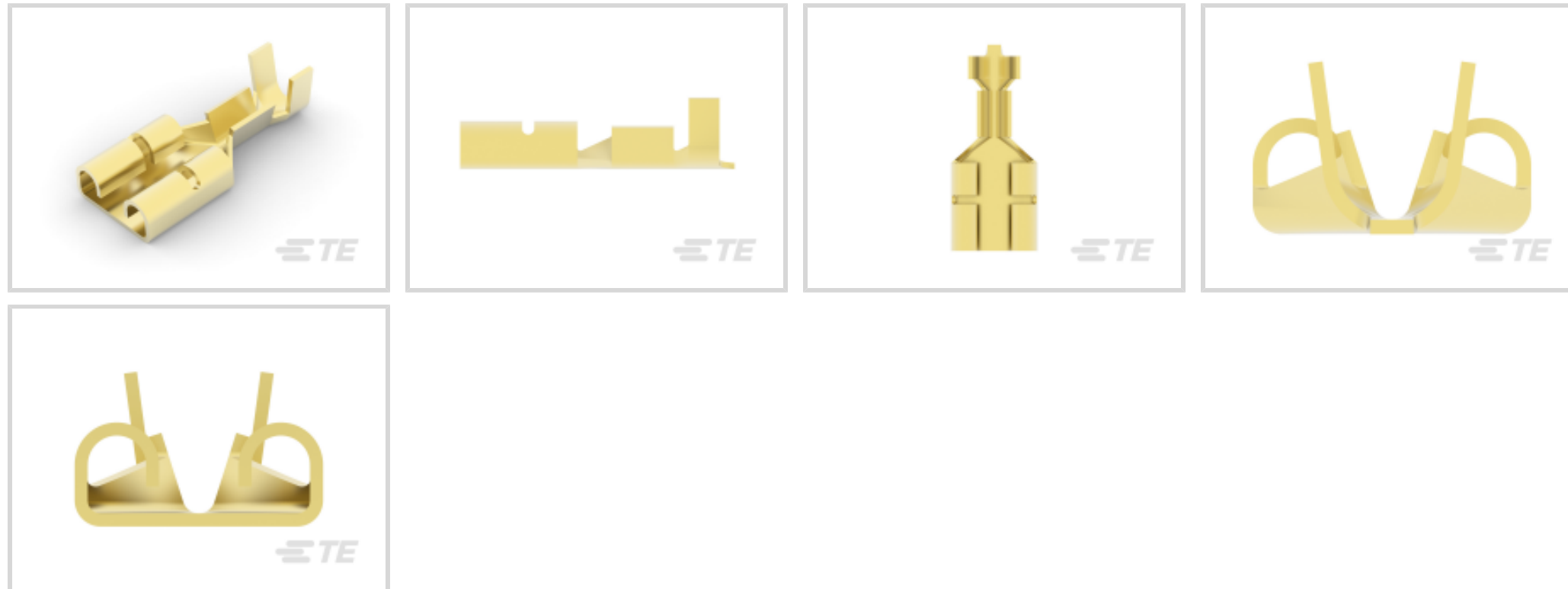

Terminals & Splices > Quick Disconnects



Quick Disconnect Terminal Type: **Receptacle**

Wire Size: .32 – .82 mm<sup>2</sup>

Mating Tab Width: 6.35 mm [ .25 in ]

Mating Tab Thickness: .81 mm [ .032 in ]

## Features

### Product Type Features

Terminates To	Wire & Cable
Wire Stop	No
Wire/Cable Type	Discrete Wire
Insertion Force	Low
Sealable	No

### Electrical Characteristics

Voltage (Max)	240 V
---------------	-------

### Contact Features

Quick Disconnect Terminal Type	Receptacle
Mating Tab Width	6.35 mm[.25 in]
Mating Tab Thickness	.81 mm[.032 in]
Terminal Orientation	Straight
Contact Base Material	Brass
Terminal Plating Material	Unplated
Crimp Type	F-Crimp



Barrel Type	Open
-------------	------

### Mechanical Attachment

Mating Retention Type	Dimple
Extraction Force	40 Newton
Wire Insulation Support	With

### Dimensions

Accepts Wire Insulation Diameter Range	2.31 – 3.3 mm [.091 – .13 in]
Overall Length	17.1 mm [.67 in]
Receptacle Terminal Stock Thickness	.41 mm [.016 in]
Wire Size	.32 – .82 mm <sup>2</sup>

### Usage Conditions

Insulation Option	Uninsulated
Operating Temperature Range	-40 – 110 °C [-40 – 230 °F]

### Industry Standards

UL Rating	Listed
-----------	--------

### Packaging Features

Packaging Quantity	10000
Packaging Method	Strip/Reel

### Product Compliance





[For compliance documentation, visit the product page on TE.com>](#)

EU RoHS Directive 2011/65/EU	Compliant
EU ELV Directive 2000/53/EC	Compliant
China RoHS 2 Directive MIIT Order No 32, 2016	No Restricted Materials Above Threshold
EU REACH Regulation (EC) No. 1907/2006	Current ECHA Candidate List: JUNE 2022 (224) Candidate List Declared Against: JAN 2022 (223) SVHC > Threshold: Not Yet Reviewed
Halogen Content	Low Halogen - Br, Cl, F, I < 900 ppm per homogenous material. Also BFR/CFR/PVC Free
Solder Process Capability	Not applicable for solder process capability

## Product Compliance Disclaimer

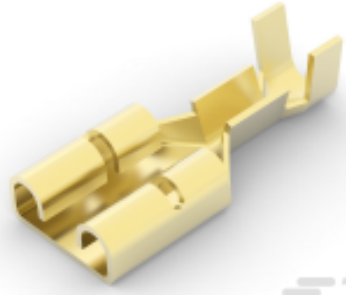
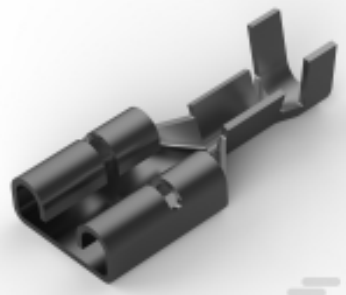
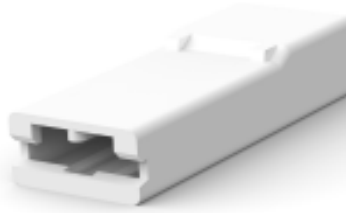
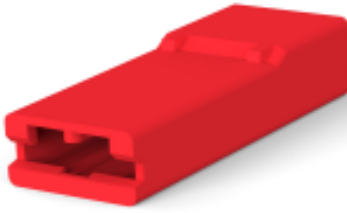
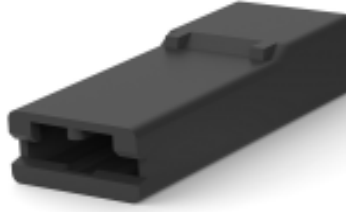
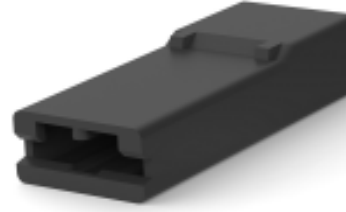
This information is provided based on reasonable inquiry of our suppliers and represents our current actual knowledge based on the information they provided. This information is subject to change. The part numbers that TE has identified as EU RoHS compliant have a maximum concentration of 0.1% by weight in homogenous materials for lead, hexavalent chromium, mercury, PBB, PBDE, DBP, BBP, DEHP, DIBP, and 0.01% for cadmium, or qualify for an exemption to these limits as defined in the Annexes of Directive 2011/65/EU (RoHS2). Finished electrical and electronic equipment products will be CE marked as required by Directive 2011/65/EU. Components may not be CE marked. Additionally, the part numbers that TE has identified as EU ELV compliant have a maximum concentration of 0.1% by weight in homogenous materials for lead, hexavalent chromium, and mercury, and 0.01% for cadmium, or qualify for an exemption to these limits as defined in the Annexes of Directive 2000/53/EC (ELV). Regarding the REACH Regulation, the information TE provides on SVHC in articles for this part number is based on the latest European Chemicals Agency (ECHA) 'Guidance on requirements for substances in articles' posted at this URL: <https://echa.europa.eu/guidance-documents/guidance-on-reach>

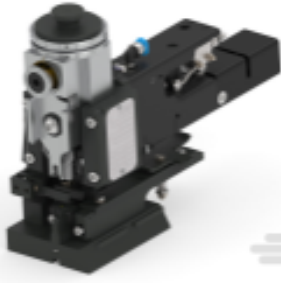
## Compatible Parts

 <p>TE Part # 444334-3 250 FASTON REC 22-18 AWG BR</p>	 <p>TE Part # 444334-2 250 FASTON REC 22-18 AWG TPBR</p>	 <p>TE Part # 1-2133346-0 250 FASTON HSG.,REC.,1 POS, NATURAL</p>	 <p>TE Part # 1-2133346-1 250 FASTON HSG.,REC.,1 POS,RED</p>
 <p>TE Part # 1-2133346-4 250 FASTON HSG.,REC.,1 POS,BLACK</p>	 <p>TE Part # 2-2133346-0 250 FASTON HSG.,REC.,1 POS,BLACK</p>	 <p>TE Part # 2-2150161-1 OCEAN_2.0_Applicator-E-090F130F</p>	 <p>TE Part # 2-2150161-2 OCEAN_2.0_Applicator-E-090F130F</p>
 <p>TE Part # 2150161-1 OCEAN_2.0_Applicator-E-090F130F</p>	 <p>TE Part # 2150161-2 OCEAN_2.0_Applicator-E-090F130F</p>	 <p><b>KIT</b> REPRESENTATION ONLY</p> <p>TE Part # 7-2150161-7 OCEAN_2.0_SPARE_PART_KIT- 090F130F</p>	

Also in the Series | **FASTON 250**



Compression Connectors(4)



Crimp Terminal Housings(143)



Insertion & Extraction Tools(6)



Magnet Wire Terminals(1)



PCB Terminals(144)



Quick Disconnects(456)



Splices(4)

## Customers Also Bought



TE Part #880688-1  
FF 250 TERMINAL 0.5-1.0MM2 0.39 X13.2 BR



TE Part #926820-5  
PL 250 REC TERMINAL-FLAG 20-15 AWG BR

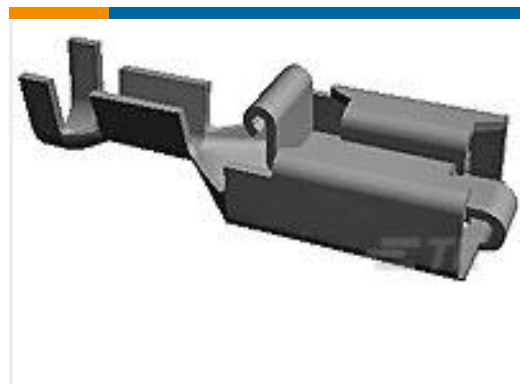

TE Part #880646-1  
PL REC 0.5-1.0MM2 0.40 X 52.32 BR



TE Part #4-280050-1  
250 FASTON,FLAG,REC.,16-20 AWG, BR



TE Part #626041-1  
110 FASTON REC 22-16 AWG BR

## Documents

### Product Drawings

250 FASTON REC 22-18 AWG BR

English

### CAD Files

3D PDF

3D

Customer View Model

ENG\_CVM\_CVM\_444334-1\_J\_c-444334-1-j.2d\_dxf.zip



English

**Customer View Model**

[ENG\\_CVM\\_CVM\\_444334-1\\_J\\_c-444334-1-j.3d\\_igs.zip](#)

English

**Customer View Model**

[ENG\\_CVM\\_CVM\\_444334-1\\_J\\_c-444334-1-j.3d\\_stp.zip](#)

English

By downloading the CAD file I accept and agree to the [Terms and Conditions](#) of use.

---

**Product Specifications**

**Product Specification**

English

---

**Product Environmental Compliance**

[MD\\_444334-1\\_101220171239\\_dmtec](#)

English

[MD\\_444334-1\\_101220171239\\_dmtec](#)

English

---

**Agency Approvals**

**Agency Approval Document**

English