

PLEASE CHECK WWW.MOLEX.COM FOR LATEST PART INFORMATION

Part Number: [5041930600](#)
Status: **Active**
Overview: [Micro-Lock™ Connectors](#)
Description: [Micro-Lock 1.25mm Pitch Single-Row Crimp Housing, White, 6 Circuits, 5041930600](#)

Documents:

3D Model	Application Specification AS-504193-002-001 (PDF)
Drawing (PDF)	Packaging Specification SPK-504193-001-001 (PDF)
Product Specification PS-504193-001-001 (PDF)	RoHS Certificate of Compliance (PDF)
Application Specification AS-504193-001-001 (PDF)	

General

Product Family	Crimp Housings
Series	504193
Application	Wire-to-Board
Overview	Micro-Lock™ Connectors
Product Name	Micro-Lock
UPC	887191165622

Physical

Circuits (maximum)	6
Color - Resin	White
Gender	Receptacle
Glow-Wire Capable	No
Lock to Mating Part	Yes
Material - Resin	Polyester
Net Weight	125.257/mg
Number of Rows	1
Packaging Type	Tray
Panel Mount	No
Pitch - Mating Interface	1.25mm
Pitch - Termination Interface	1.25mm
Polarized to Mating Part	Yes
Temperature Range - Operating	-25° to +85°C

Electrical

Current - Maximum per Contact	1.5A
-------------------------------	------

Material Info

Reference - Drawing Numbers

Application Specification	AS-504193-001-001, AS-504193-002-001
Packaging Specification	SPK-504193-001-001
Product Specification	PS-504193-001-001
Sales Drawing	SD-504193-001

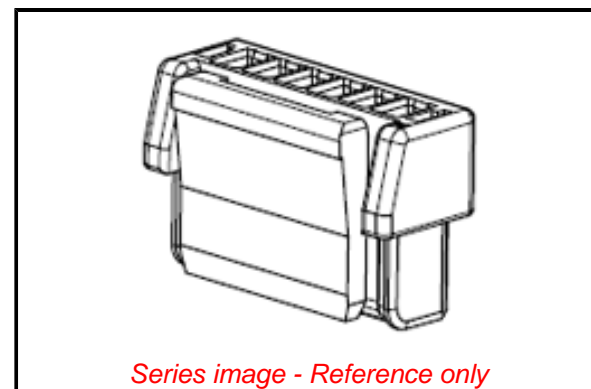

Series image - Reference only

EU ELV

Not Relevant

EU RoHS

Compliant

REACH SVHC

Not Contained Per -
ED/71/2019 (16 July
2019)

Halogen-Free

Status

Not Low-Halogen

For more information, please visit [Contact US](#)

China ROHS

ELV

RoHS Phthalates

China RoHS

Green Image

Not Relevant

Not Contained

Search Parts in this Series

[504193 Series](#)

Mates With

[504194](#) Micro-Lock 1.25mm Pitch Vertical Header, [504195](#) Micro-Lock 1.25mm Pitch Right Angle Header

Use With

Micro-Lock Wire-to-Board Crimp Terminal
[5041851000](#)