

5-103669-9 ✓ ACTIVE

AMPMODU | AMPMODU MTE

TE Internal #: 5-103669-9

PCB Mount Header, Vertical, Wire-to-Board, 10 Position, .1 in [2.54 mm] Centerline, Fully Shrouded, Tin, Through Hole - Solder, Signal, AMPMODU MTE

[View on TE.com >](#)



Connectors > PCB Connectors > PCB Headers & Receptacles

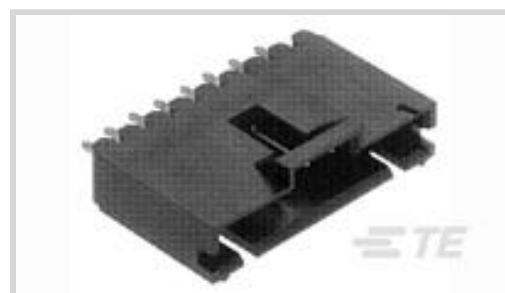

Connector System: **Wire-to-Board**

Number of Positions: **10**

Number of Rows: **1**

Centerline (Pitch): **2.54 mm [.1 in]**

PCB Mount Orientation: **Vertical**

Features

Product Type Features

Connector System	Wire-to-Board
Header Type	Fully Shrouded
Sealable	No
Connector & Contact Terminates To	Printed Circuit Board
PCB Connector Assembly Type	PCB Mount Header

Configuration Features

Number of Positions	10
Number of Rows	1
PCB Mount Orientation	Vertical

Electrical Characteristics

Termination Resistance	15 mΩ
Insulation Resistance	5000 MΩ
Dielectric Withstanding Voltage (Max)	600 V

Body Features

Primary Product Color	Black
-----------------------	-------

Contact Features

Contact Mating Area Length	5.84 mm[.23 in]
Mating Square Post Dimension	.64 mm[.025 in]



PCB Contact Termination Area Plating Material Thickness	2.54 µm[100 µin]
Contact Mating Area Plating Material Thickness	2.54 µm[100 µin]
PCB Contact Termination Area Plating Material Finish	Matte
Contact Shape & Form	Square
Contact Mating Area Plating Material Finish	Bright
PCB Contact Termination Area Plating Material	Tin
Contact Base Material	Brass
Contact Mating Area Plating Material	Tin
Contact Type	Pin
Contact Current Rating (Max)	3 A

Termination Features

Square Termination Post & Tail Dimension	.64 mm[.025 in]
Termination Post & Tail Length	3.3 mm[.13 in]
Termination Method to Printed Circuit Board	Through Hole - Solder

Mechanical Attachment

Mating Alignment Type	Latched, Polarization
Mating Retention	With
PCB Mount Retention Type	Swaged Retention Tails
Mating Retention Type	Hold-Down
Connector Mounting Type	Board Mount
Mating Alignment	With
PCB Mount Alignment	Without
PCB Mount Retention	With

Housing Features

Housing Material	Thermoplastic
Centerline (Pitch)	2.54 mm[.1 in]

Dimensions

Connector Length	27.94 mm[1.1 in]
Connector Height	13.59 mm[.535 in]
PCB Thickness (Recommended)	1.57 mm[.062 in]

Usage Conditions

Operating Temperature Range	-65 – 105 °C[-85 – 221 °F]
-----------------------------	----------------------------



Operation/Application

Circuit Application	Signal
---------------------	--------

Industry Standards

CSA Rating	Certified
Approved Standards	CSA LR7189, UL E28476
UL Flammability Rating	UL 94V-0

Packaging Features

Packaging Quantity	19
Packaging Type	Box, Tube

Product Compliance

[For compliance documentation, visit the product page on TE.com>](#)

EU RoHS Directive 2011/65/EU	Compliant
EU ELV Directive 2000/53/EC	Compliant
China RoHS 2 Directive MIIT Order No 32, 2016	No Restricted Materials Above Threshold
EU REACH Regulation (EC) No. 1907/2006	Current ECHA Candidate List: JUNE 2022 (224) Candidate List Declared Against: JAN 2022 (223) SVHC > Threshold: Not Yet Reviewed
Halogen Content	Low Halogen - Br, Cl, F, I < 900 ppm per homogenous material. Also BFR/CFR/PVC Free
Solder Process Capability	Reflow solder capable to 260°C

Product Compliance Disclaimer

This information is provided based on reasonable inquiry of our suppliers and represents our current actual knowledge based on the information they provided. This information is subject to change. The part numbers that TE has identified as EU RoHS compliant have a maximum concentration of 0.1% by weight in homogenous materials for lead, hexavalent chromium, mercury, PBB, PBDE, DBP, BBP, DEHP, DIBP, and 0.01% for cadmium, or qualify for an exemption to these limits as defined in the Annexes of Directive 2011/65/EU (RoHS2). Finished electrical and electronic equipment products will be CE marked as required by Directive 2011/65/EU. Components may not be CE marked. Additionally, the part numbers that TE has identified as EU ELV compliant have a maximum concentration of 0.1% by weight in homogenous materials for lead, hexavalent chromium, and mercury, and 0.01% for cadmium, or qualify for an exemption to these limits as defined in the Annexes of Directive 2000/53/EC (ELV). Regarding the REACH Regulation, the information TE provides on SVHC in articles for this part number is based on the latest European Chemicals Agency (ECHA) 'Guidance on requirements for substances in articles' posted at this URL: <https://echa.europa.eu/guidance-documents/guidance-on-reach>

Compatible Parts



TE Part # 487526-9
010 HOUSING FFC RCPT 100CL SR



TE Part # 103648-9
10 MTE RCPT HSG SR RIB .100CL



TE Part # 5-103956-9
2X10 MTE RCPT SR LATCH .100CL



TE Part # 5-103959-9
2X10 MTE RCPT SR LATCH .100CL



TE Part # 91417-1
TOOL, KEYING (AMPMODU MTE)

Also in the Series | AMPMODU MTE



Insertion & Extraction Tools(2)



PCB Connector Shrouds(40)



PCB Headers & Receptacles(763)



Ribbon Connector Accessories(1)



Standard Rectangular Connectors(2)



Wire-to-Board Connector Assemblies & Housings(585)



Wire-to-Board Connector Contacts(32)

Customers Also Bought



TE Part #1-745494-5
15 HDE MS PLUG,22-26,LEAD FREE



TE Part #205201-7
SOCKET CONT.



TE Part #1-480438-0
16P CMNL PLUG HSG M/M NATL



TE Part #5-103957-9
2X10 MTE RCPT SR LATCH .100CL



Documents

CAD Files

3D PDF

3D

Customer View Model

[ENG_CVM_CVM_5-103669-9_AB.2d_dxf.zip](#)

English

Customer View Model

[ENG_CVM_CVM_5-103669-9_AB.3d_igs.zip](#)

English

Customer View Model

[ENG_CVM_CVM_5-103669-9_AB.3d_stp.zip](#)

English

By downloading the CAD file I accept and agree to the [Terms and Conditions](#) of use.

Datasheets & Catalog Pages

[AMP MODU MTE Section of Catalog 1307819](#)

English

[AMPMODU_INTERCONNECTION_SYSTEM_SECTION5_CONT](#)

English

[AMPMODU MTE INTERCONNECT SYSTEM](#)

English

Product Specifications

[Application Specification](#)

English