

**PLEASE CHECK WWW.MOLEX.COM FOR LATEST PART INFORMATION**

**Part Number:** **5037763010**  
**Status:** **Active**  
**Overview:** SlimStack™ 0.40mm Pitch Board-to-Board Connectors  
**Description:** 0.40mm Pitch SlimStack B8 Board-to-Board Plug, Surface Mount, Dual Row, Vertical, 0.80mm Stacking Height, 30 Circuits

**Documents:**

<a href="#">3D Model</a>	<a href="#">Application Specification AS-503772-001-001 (PDF)</a>
<a href="#">Drawing (PDF)</a>	<a href="#">Packaging Specification SPK-503776-001-001 (PDF)</a>
<a href="#">Product Specification PS-503772-001-001 (PDF)</a>	<a href="#">RoHS Certificate of Compliance (PDF)</a>
<a href="#">Product Specification PS-503772-002-001 (PDF)</a>	

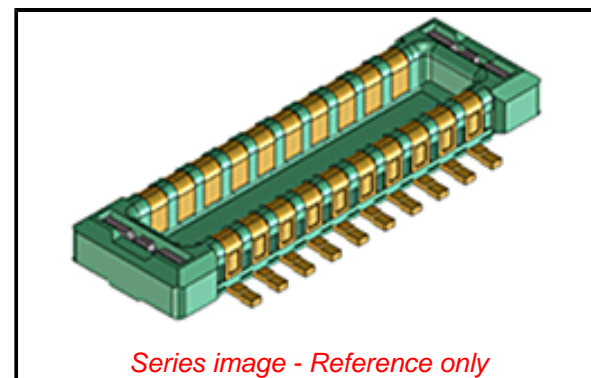

**General**

Product Family	PCB Headers
Series	503776
Application	Board-to-Board, Signal
Overview	SlimStack™ 0.40mm Pitch Board-to-Board Connectors
Product Name	SlimStack
Series Name	B8
UPC	884982408937

**Physical**

Breakaway	No
Circuits (Loaded)	30
Circuits (maximum)	30
Color - Resin	Black
Durability (mating cycles max)	30
Glow-Wire Capable	No
Lock to Mating Part	Yes
Mated Height	0.80mm
Mated Width	2.50mm
Material - Metal	Copper Alloy
Material - Plating Mating	Gold
Material - Plating Termination	Gold
Net Weight	13.750/mg
Number of Rows	2
Orientation	Vertical
PCB Locator	No
PCB Retention	Yes
Packaging Type	Embossed Tape on Reel
Pitch - Mating Interface	0.40mm
Polarized to Mating Part	No
Polarized to PCB	No
Stackable	No
Temperature Range - Operating	-40° to +85°C
Termination Interface: Style	Surface Mount

**Electrical**

Current - Maximum per Contact	0.3A
Voltage - Maximum	50V AC/DC

**Material Info**

**Reference - Drawing Numbers**

Application Specification	AS-503772-001-001
Packaging Specification	SPK-503776-001-001
Product Specification	PS-503772-001-001, PS-503772-002-001
Sales Drawing	5037760000-000, 5037761000-000

**EU ELV**

**Not Relevant**

**EU RoHS**

**Compliant**

**REACH SVHC**

Not Contained Per -  
ED/61/2018 (27 June  
2018)

**Halogen-Free**

**Status**

**Low-Halogen**

**Need more information on product  
environmental compliance?**

Email [productcompliance@molex.com](mailto:productcompliance@molex.com)  
Please visit the [Contact Us](#) section for any  
non-product compliance questions.

China ROHS

ELV

RoHS Phthalates

Green Image

Not Relevant

Not Contained

**Search Parts in this Series**

503776 Series

**Mates With**

SlimStack B8 Board-to-Board Receptacle  
503772-3010

This document was generated on 08/15/2018

**PLEASE CHECK [WWW.MOLEX.COM](http://WWW.MOLEX.COM) FOR LATEST PART INFORMATION**