

5-583853-3 ✓ ACTIVE

AMP | AMP Twin-Leaf

TE Internal #: 5-583853-3

Connector Contact, Socket, Wire-to-Board, .156 in [3.18 mm / 3.96 mm / 2.54 mm] Centerline, 24 – 20 AWG Wire Size, AMP Twin-Leaf

[View on TE.com >](#)



Connectors > PCB Connectors > Wire-to-Board Connectors > Wire-to-Board Connector Contacts

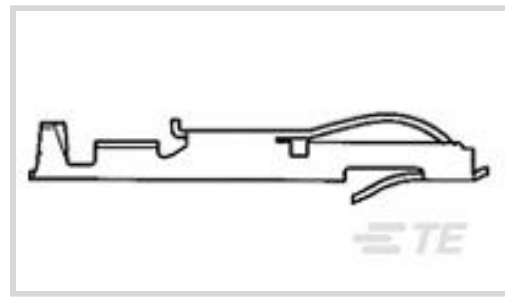

Contact Type: **Socket**

Connector System: **Wire-to-Board**

Centerline (Pitch): **2.54 mm, 3.18 mm, 3.96 mm [.156 in]**

Wire Size: **404 – 1020 CMA**

Features

Product Type Features

Connector System	Wire-to-Board
Sealable	No
Connector & Contact Terminates To	Wire & Cable

Contact Features

Contact Retention Within Housing	With
Wire Contact Termination Area Plating Material	Tin
	30 µin
PCB Contact Termination Area Plating Material Finish	Matte
PCB Contact Termination Area Plating Material	Tin
Contact Base Material	Phosphor Bronze
Contact Type	Socket
Contact Mating Area Plating Material	Gold
Contact Current Rating (Max)	5 A

Termination Features

Termination Method to Wire & Cable	Crimp
------------------------------------	-------

Mechanical Attachment

Contact Retention Type Within Housing	Locking Lance
---------------------------------------	---------------

Housing Features

Centerline (Pitch)	2.54 mm, 3.18 mm, 3.96 mm [.156 in]
--------------------	-------------------------------------

Dimensions

Accepts Wire Insulation Diameter Range	1.22 – 1.52 mm [.048 – .06 in]
Wire Size	.2 – .6 mm ²

Usage Conditions

Operating Temperature Range	-40 – 85 °C [-40 – 185 °F]
-----------------------------	----------------------------

Operation/Application

Circuit Application	Power & Signal
---------------------	----------------

Identification Marking

Wire Range Color Code	Green
-----------------------	-------

Packaging Features

Packaging Quantity	7000
Packaging Method	Strip

Product Compliance

[For compliance documentation, visit the product page on TE.com>](#)

EU RoHS Directive 2011/65/EU	Compliant
EU ELV Directive 2000/53/EC	Compliant
China RoHS 2 Directive MIIT Order No 32, 2016	No Restricted Materials Above Threshold
EU REACH Regulation (EC) No. 1907/2006	Current ECHA Candidate List: JUNE 2022 (224) Candidate List Declared Against: JAN 2022 (223) SVHC > Threshold: Not Yet Reviewed
Halogen Content	Low Halogen - Br, Cl, F, I < 900 ppm per homogenous material. Also BFR/CFR/PVC Free
Solder Process Capability	Not applicable for solder process capability

Product Compliance Disclaimer

This information is provided based on reasonable inquiry of our suppliers and represents our current actual knowledge based on the information they provided. This information is subject to change. The part numbers that TE has identified as EU RoHS compliant have a maximum concentration of 0.1% by weight in homogenous materials for lead, hexavalent chromium, mercury, PBB, PBDE, DBP, BBP, DEHP, DIBP, and 0.01% for cadmium, or qualify for an exemption to these limits as defined in the Annexes of Directive 2011/65/EU (RoHS2). Finished electrical and electronic equipment products will be CE marked as required by Directive 2011/65/EU. Components may not be CE marked. Additionally, the part numbers that TE has identified as EU ELV compliant have a maximum concentration of 0.1% by weight in homogenous materials for lead, hexavalent chromium, and mercury, and 0.01% for cadmium, or qualify for an exemption to these limits as defined in the Annexes of Directive 2000/53/EC (ELV). Regarding the REACH Regulation, the information TE provides

on SVHC in articles for this part number is based on the latest European Chemicals Agency (ECHA) 'Guidance on requirements for substances in articles' posted at this URL: <https://echa.europa.eu/guidance-documents/guidance-on-reach>

Compatible Parts

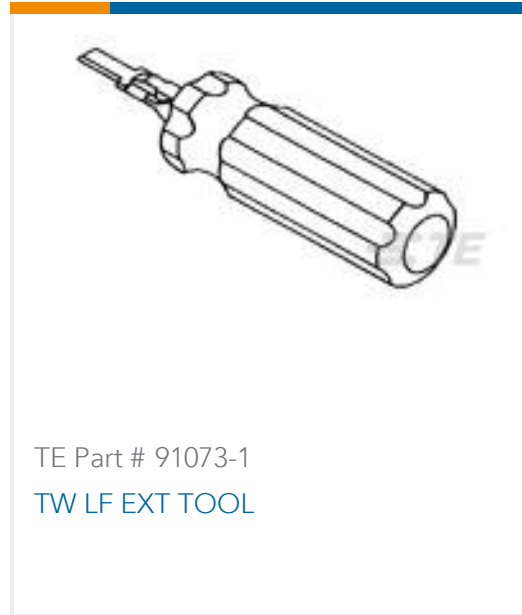

Also in the Series | AMP Twin-Leaf

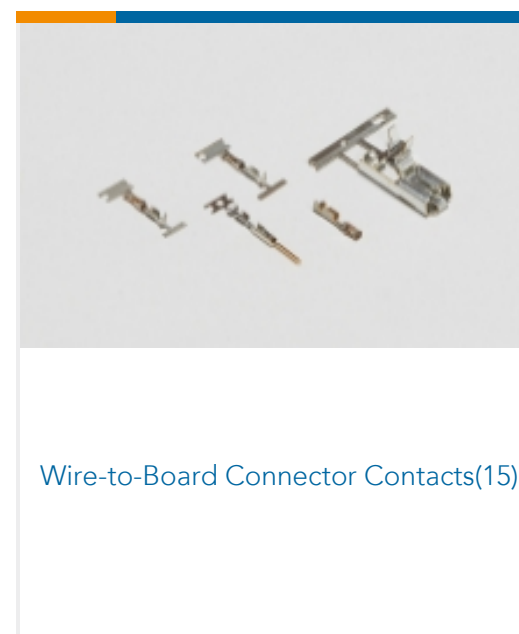
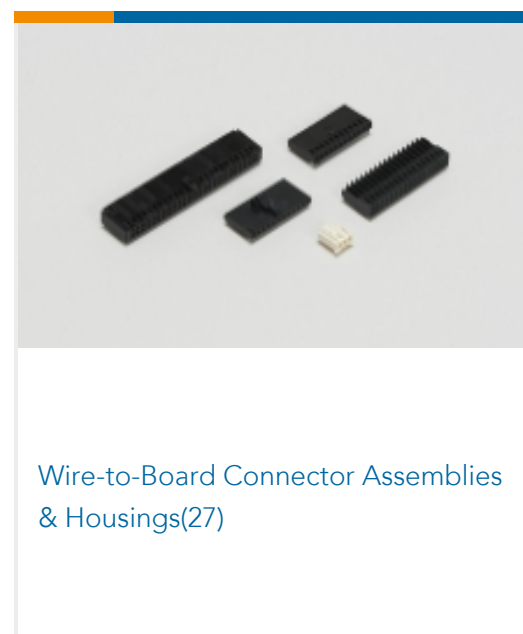
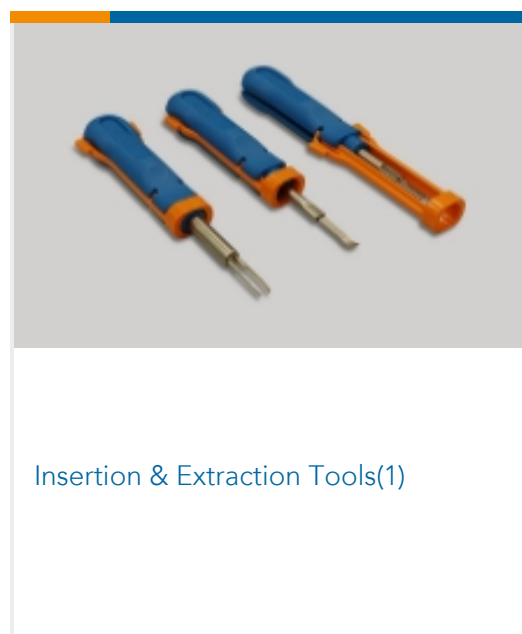

Customers Also Bought



TE Part #8-2176070-1
3521 22K 1% 2W

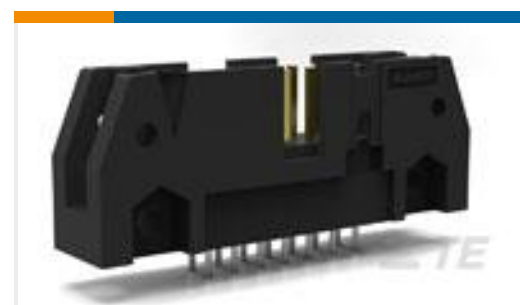

TE Part #5102153-8
A/L UNIV HDR 34P VERT



TE Part #3-643816-4
04P MTA100 CONN ASSY POL RIB

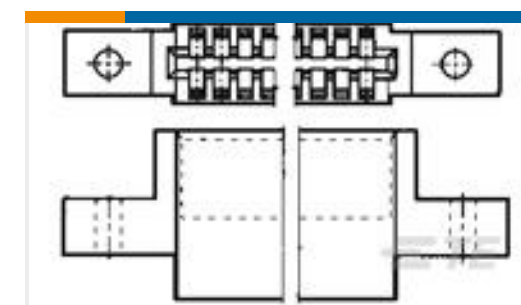

TE Part #2-583718-7
TW-LEAF CRP HSG 32 POS 100C/L



TE Part #640051-1
RING TONGUE .164 18-14 AWG SST



TE Part #1-1658620-2
064 NOVO MIL 15DP FT

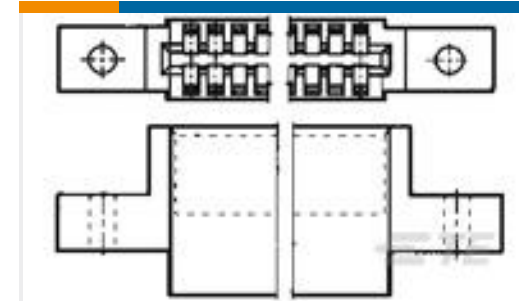

TE Part #583718-1
TW-LEAF CRP HSG 10 POS 100 C/L

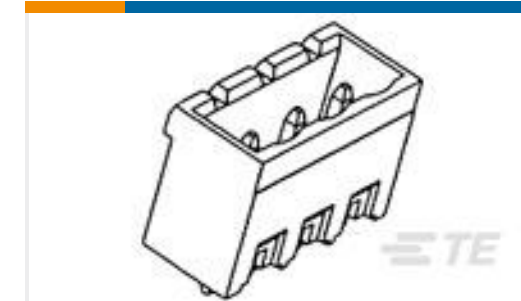

TE Part #796980-4
4 POS TERMI-BLOK VERT HDR 7.62



TE Part #3-2176331-3
CRGP 2512 4K7 1%

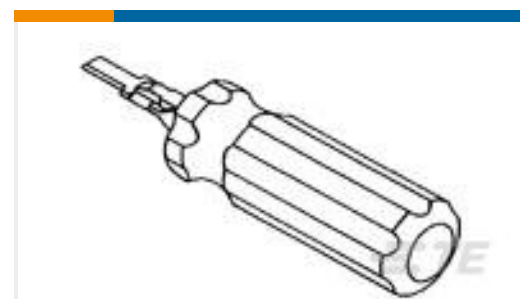

TE Part #91073-1
TW LF EXT TOOL

Documents

Product Drawings

[TWIN LEAF TERM. STRIP CSTL](#)

English

CAD Files

[3D PDF](#)

3D

Customer View Model

[ENG_CVM_CVM_5-583853-3_BR.2d_dxf.zip](#)

English

Customer View Model

[ENG_CVM_CVM_5-583853-3_BR.3d_igs.zip](#)

English

Customer View Model

[ENG_CVM_CVM_5-583853-3_BR.3d_stp.zip](#)

English

Customer View Model

[ENG_CVM_5-583853-3_V1.3d_igs.zip](#)

English



3D PDF

English

Customer View Model

[ENG_CVM_5-583853-3_V1.2d_dxf.zip](#)

English

Customer View Model

[ENG_CVM_5-583853-3_V1.3d_stp.zip](#)

English

By downloading the CAD file I accept and agree to the [Terms and Conditions](#) of use.

Product Specifications

[Application Specification](#)

English

Product Environmental Compliance

[TE Material Declaration](#)

English