

Solderless terminals

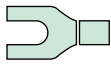

SPADE TONGUE (A type) Non-insulated

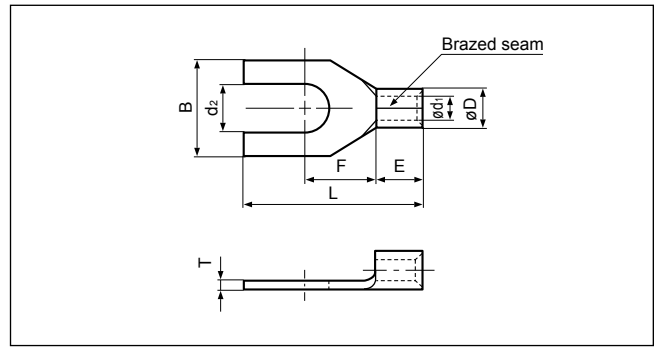
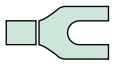

Certificate No.: E42024 LR20812

Applicable Wire AWG#(mm ²)	Stud size		Part No.	Standard	Dimensions mm (in.)								Tool No.	Qty/box
	American	Metric			d ₂	B	L	F	E	øD	ød ₁	T		
26 to 22 (0.2 to 0.5)	1-2	2	0.5-2A		2.2 (.087)	4.6 (.181)	12.8 (.504)	4.5 (.177)	4.0 (.157)	2.0 (.079)	1.0 (.039)	0.5 (.020)	YHT-2622 YA-1 YA-2 BCT-0514L	1,000
	3-4	3	0.5-3A		3.2 (.126)	5.0 (.197)	12.5 (.492)	6.0 (.236)						
	5-6	3.5	0.5-3.7A		3.7 (.146)	6.4 (.252)	15.0 (.591)	7.7 (.303)						
	8	4	0.5-4A		2.2 (.087)	4.6 (.181)	14.6 (.575)	4.3 (.169)						
22 to 16 (0.25 to 1.65)	3-4	3	1.25-C3A		3.2 (.126)	5.6 (.221)	15.8 (.622)	6.3 (.248)	4.8 (.189)	3.4 (.134)	1.7 (.067)	0.8 (.031)	YHT-2210 YA-1 YA-2 YA-4 BCT-0514L	1,000
	3-4	3	1.25-B3A		3.2 (.126)	5.8 (.228)	15.8 (.622)	6.3 (.248)						
	3-4	3	1.25-M3A		3.2 (.126)	6.35(.250)	16.0 (.630)	8.0 (.315)						
	5-6	3.5	1.25-C3.5A		3.7 (.146)	5.6 (.221)	15.8 (.622)	6.3 (.248)						
	5-6	3.5	1.25-B3.5A		3.7 (.146)	5.8 (.228)	15.8 (.622)	6.3 (.248)						
	5-6	3.5	1.25-N3A		3.7 (.146)	6.2 (.244)	15.8 (.622)	6.3 (.248)						
	5-6	3.5	1.25-YS3A		3.7 (.146)	6.4 (.252)	15.4 (.606)	6.3 (.248)						
	5-6	3.5	1.25-S3A		3.7 (.146)	7.2 (.283)	15.8 (.622)	6.3 (.248)						
	5-6	3.5	1.25-P3A		3.7 (.146)	7.5 (.295)	13.8 (.543)	5.5 (.217)						
	8	4	1.25-YS4A		4.3 (.169)	6.4 (.252)	15.4 (.606)	6.3 (.248)						
	8	4	1.25-S4A		4.3 (.169)	7.2 (.283)	15.8 (.622)	6.3 (.248)						
	8	4	1.25-4A		4.3 (.169)	8.5 (.335)	15.8 (.622)	7.0 (.276)						
	10	5	1.25-S5A		5.3 (.209)	7.2 (.283)	15.8 (.622)	6.3 (.248)						
	10	5	1.25-M5A		5.3 (.209)	8.5 (.335)	15.8 (.622)	7.0 (.276)						
10	5	1.25-5A	5.3 (.209)	9.5 (.374)	15.8 (.622)	7.0 (.276)								
1/4	6	1.25-6A	6.4 (.252)	12.0 (.472)	22.0 (.866)	11.0 (.433)								
16 to 14 (1.04 to 2.63)	3-4	3	2-N3A		3.2 (.126)	5.9 (.232)	15.8 (.622)	6.3 (.248)	4.8 (.189)	4.1 (.161)	2.3 (.091)	0.8 (.031)	YHT-2210 YA-1 YA-2 YA-4 BCT-0514L	1,000
	3-4	3	2-M3A		3.2 (.126)	6.0 (.236)	14.5 (.571)	5.0 (.197)						
	5-6	3.5	2-C3.5A		3.7 (.146)	5.6 (.220)	15.8 (.622)	6.3 (.248)						
	5-6	3.5	2-YS3A		3.7 (.146)	6.4 (.252)	15.4 (.606)	6.3 (.248)						
	5-6	3.5	2-S3A		3.7 (.146)	7.2 (.283)	16.0 (.630)	6.5 (.256)						
	8	4	2-YS4A		4.3 (.169)	6.4 (.252)	15.4 (.606)	6.3 (.248)						
	8	4	2-YM4A		4.3 (.169)	6.8 (.268)	15.4 (.606)	6.3 (.248)						
	8	4	2-S4A		4.3 (.169)	7.2 (.283)	16.0 (.630)	6.5 (.256)						
	8	4	2-4A		4.3 (.169)	8.5 (.335)	16.8 (.661)	7.3 (.287)						
	10	5	2-M5A		5.3 (.209)	8.5 (.335)	16.8 (.661)	7.3 (.287)						
	10	5	2-5A		5.3 (.209)	9.5 (.374)	16.8 (.661)	7.3 (.287)						
	1/4	6	2-6A		6.4 (.252)	12.0 (.472)	22.0 (.866)	11.0 (.433)						
12 to 10 (2.63 to 6.64)	5-6	3.5	5.5-S3A		3.7 (.146)	7.2 (.283)	19.5 (.768)	7.5 (.295)	6.8 (.268)	5.6 (.220)	3.4 (.134)	1.0 (.039)	YHT-2210 YA-1 YA-2 YA-4 BCT-0514L	500
	5-6	3.5	5.5-3A		3.7 (.146)	9.5 (.374)	19.5 (.768)	7.5 (.295)						
	8	4	5.5-S4A		4.3 (.169)	8.5 (.335)	19.5 (.768)	7.5 (.295)						
	8	4	5.5-4A		4.3 (.169)	9.5 (.374)	19.5 (.768)	7.5 (.295)						
	10	5	5.5-5A		5.3 (.209)	9.5 (.374)	19.5 (.768)	7.5 (.295)						
	1/4	6	5.5-6A		6.4 (.252)	13.5 (.532)	25.5(1.004)	12.2 (.480)						
	5/16	8	5.5-8A		8.4 (.331)	13.5 (.532)	25.5(1.004)	12.2 (.480)						

Note:1) The part numbers indicated in the above table are for products with a brazed seam.
When ordering products with a butted seam, add the prefix "WS" to the part number (ex. 2-4A -> **WS2-4A**).
2) Delivery lead times may vary depending on the product. Contact JST for details.

Solderless terminals

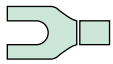

SPADE TONGUE (A type) Vinyl-insulated

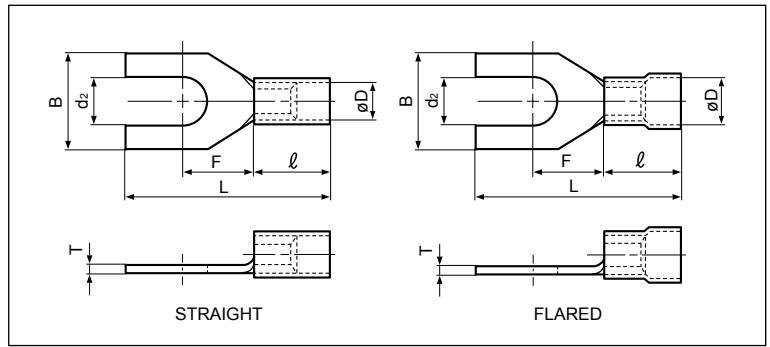
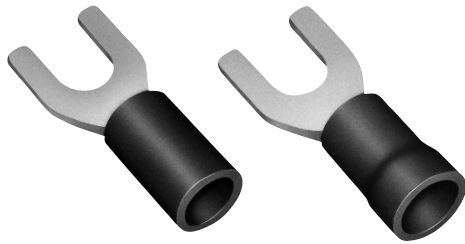
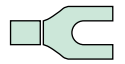

Certificate No.: E42024 LR20812

Applicable Wire AWG#(mm ²)	Stud size		Part No.		Standard	Dimensions mm (in.)							Color	Tool No.	Qty/box	
	American	Metric	Straight	Flared		d ₂	B	L	F	ℓ	ø D					T
26 to 22 (0.2 to 0.5)	3-4	3	V0.5-3A	FV0.5-3A		3.2 (.126)	5.0 (.197)	16.5 (.650)	6.0 (.236)	8.0	1.9	2.9	0.5	Yellow	YNT-2622 YA-1,YA-2 BCT-0514L	1,000
	5-6	3.5	V0.5-3.7A	FV0.5-3.7A		3.7 (.146)	6.4 (.252)	19.0 (.748)	7.7 (.303)	(.315)	(.075)	(.114)	(.020)			
22 to 16 *(0.25 to 1.65)	1-2	2	V1.25-2A	FV1.25-2A		2.2 (.087)	4.6 (.181)	18.8 (.740)	4.3 (.169)	9.0 (.354)	3.2 (.126)	4.0 (.157)	0.8 (.031)	Red	YNT-2216 YA-1 YA-2 YA-4 BCT-0514L	1,000
	3-4	3	V1.25-B3A	FV1.25-B3A		3.2 (.126)	5.8 (.228)	20.0 (.787)	6.3 (.248)							
	5-6	3.5	V1.25-C3.5A	—		3.7 (.146)	5.6 (.220)	20.0 (.787)	6.3 (.248)							
	5-6	3.5	V1.25-N3A	FV1.25-N3A		3.7 (.146)	6.2 (.244)	20.0 (.787)	6.3 (.248)							
	5-6	3.5	V1.25-YS3A	FV1.25-YS3A		3.7 (.146)	6.4 (.252)	19.6 (.772)	6.3 (.248)							
	5-6	3.5	V1.25-S3A	FV1.25-S3A		3.7 (.146)	7.2 (.284)	20.0 (.787)	6.3 (.248)							
	8	4	V1.25-YS4A	FV1.25-YS4A		4.3 (.169)	6.4 (.252)	19.6 (.772)	6.3 (.248)							
	8	4	V1.25-S4A	FV1.25-S4A		4.3 (.169)	7.2 (.284)	20.0 (.787)	6.3 (.248)							
	8	4	V1.25-4A	FV1.25-4A		4.3 (.169)	8.5 (.335)	20.0 (.787)	7.0 (.276)							
	10	5	V1.25-S5A	FV1.25-S5A		5.3 (.209)	7.2 (.284)	20.0 (.787)	6.3 (.248)							
	10	5	—	FV1.25-M5A		5.3 (.209)	8.5 (.335)	20.0 (.787)	7.0 (.276)							
10	5	V1.25-5A	FV1.25-5A	5.3 (.209)	9.5 (.374)	20.0 (.787)	7.0 (.276)									
1/4	6	V1.25-6A	FV1.25-6A	6.4 (.252)	12.0 (.472)	26.2(1.032)	11.0 (.433)									
16 to 14 (1.04 to 2.63)	3-4	3	V2-N3A	FV2-N3A		3.2 (.126)	5.9 (.232)	20.0 (.787)	6.3 (.248)	9.0 (.354)	3.9 (.154)	4.5 (.177)	0.8 (.031)	Blue	YNT-1614 YA-1 YA-2 YA-4 BCT-0514L	1,000
	5-6	3.5	V2-YS3A	FV2-YS3A		3.7 (.146)	6.4 (.252)	19.6 (.772)	6.3 (.248)							
	5-6	3.5	V2-S3A	FV2-S3A		3.7 (.146)	7.2 (.284)	20.2 (.795)	6.5 (.256)							
	5-6	3.5	V2-3A	—		3.7 (.146)	8.5 (.335)	21.0 (.827)	7.3 (.287)							
	8	4	V2-YS4A	FV2-YS4A		4.3 (.169)	6.4 (.252)	19.6 (.772)	6.3 (.248)							
	8	4	—	FV2-YM4A		4.3 (.169)	6.8 (.268)	19.6 (.772)	6.3 (.248)							
	8	4	V2-S4A	FV2-S4A		4.3 (.169)	7.2 (.284)	20.2 (.795)	6.5 (.256)							
	8	4	V2-4A	FV2-4A		4.3 (.169)	8.5 (.335)	21.0 (.827)	7.3 (.287)							
	10	5	V2-M5A	FV2-M5A		5.3 (.209)	8.5 (.335)	21.0 (.827)	7.3 (.287)							
	10	5	V2-5A	FV2-5A		5.3 (.209)	9.5 (.374)	21.0 (.827)	7.3 (.287)							
1/4	6	V2-6A	FV2-6A	6.4 (.252)	12.0 (.472)	26.2(1.032)	11.0 (.433)									
12 to 10 (2.63 to 6.64)	5-6	3.5	V5.5-S3A	FV5.5-S3A		3.7 (.146)	7.2 (.283)	26.2(1.032)	7.5 (.295)	13.5 (.531)	5.4 (.213)	6.8 (.268)	1.0 (.039)	Yellow	YNT-1210S YA-4 BCT-0514L	500
	5-6	3.5	V5.5-3A	FV5.5-3A		3.7 (.146)	9.5 (.374)	26.2(1.032)	7.5 (.295)							
	8	4	V5.5-S4A	FV5.5-S4A		4.3 (.169)	8.5 (.335)	26.2(1.032)	7.5 (.295)							
	8	4	V5.5-4A	FV5.5-4A		4.3 (.169)	9.5 (.374)	26.2(1.032)	7.5 (.295)							
	10	5	V5.5-5A	FV5.5-5A		5.3 (.209)	9.5 (.374)	26.2(1.032)	7.5 (.295)							
	1/4	6	V5.5-6A	FV5.5-6A		6.4 (.252)	13.5 (.532)	32.2(1.268)	12.2 (.480)							

- Note: 1) *The crimping will be more secure if the total cross-sectional area of the wire is at least 0.5 mm².
 Examples: If the cross-sectional area of the wire is 0.3 mm², fold the wire in two when crimping the terminal.
 If the cross-sectional area of the wire is 0.5 mm², crimp the terminal onto the wire as it is.
- The part numbers indicated in the above table are for products with a brazed seam.
 When ordering products with a butted seam, add the prefix "WS" to the part number (ex. V2-4A → **VWS2-4A**).
 - To order products with nylon insulation, change the "V" in the part number prefix to "N" (ex. V2-4A → **N2-4A**).
 Because nylon absorbs moisture, care must be taken concerning storage.
 - Delivery lead times may vary depending on the product. Contact JST for details.

Solderless terminals

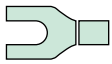

SPADE TONGUE (A type) vinyl-insulated (funnel-entry)

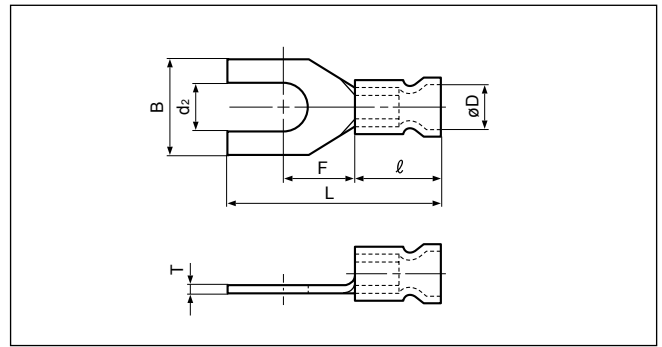
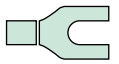

Certificate No.: E42024 LR20812

Applicable Wire AWG#(mm ²)	Stud size		Part No.	Standard	Dimensions mm (in.)							Color	Tool No.	Qty/box
	American	Metric			d ₂	B	L	F	ℓ	øD	T			
22 to 16 *(0.25 to 1.65)	3-4	3	FVX1.25-B3A		3.2 (.126)	5.8 (.228)	21.8 (.858)	6.3 (.248)	10.8 (.425)	4.0 (.157)	0.8 (.031)	Red	YNT-2216 YA-1 YA-2 YA-4 BCT-0514L	1,000
	5-6	3.5	FVX1.25-N3A		3.7 (.146)	6.2 (.244)	21.8 (.858)	6.3 (.248)						
	5-6	3.5	FVX1.25-YS3A		3.7 (.146)	6.4 (.252)	21.4 (.843)	6.3 (.248)						
	8	4	FVX1.25-YS4A		4.3 (.169)	6.4 (.252)	21.4 (.843)	6.3 (.248)						
	10	5	FVX1.25-5A		5.3 (.209)	9.5 (.374)	21.8 (.858)	7.0 (.276)						
16 to 14 (1.04 to 2.63)	3-4	3	FVX2-N3A		3.2 (.126)	5.9 (.232)	21.8 (.858)	6.3 (.248)	10.8 (.425)	4.6 (.181)	0.8 (.031)	Blue	BCT-0514 YNT-1614 YA-1 YA-2 YA-4 BCT-0514L	1,000
	5-6	3.5	FVX2-YS3A		3.7 (.146)	6.4 (.252)	21.4 (.843)	6.3 (.248)						
	5-6	3.5	FVX2-S3A		3.7 (.146)	7.2 (.284)	23.0 (.906)	6.5 (.256)						
	8	4	FVX2-YS4A		4.3 (.169)	6.4 (.252)	21.4 (.843)	6.3 (.248)						
	8	4	FVX2-YM4A		4.3 (.169)	6.8 (.268)	21.4 (.843)	6.3 (.248)						
	8	4	FVX2-4A		4.3 (.169)	8.5 (.335)	22.8 (.898)	7.3 (.287)						
12 to 10 (2.63 to 6.64)	8	4	FVX5.5-S4A		4.3 (.169)	8.5 (.335)	26.7(1.051)	7.5 (.295)	14.0 (.551)	6.8 (.268)	1.0 (.039)	Yellow	YNT-1210S YA-4 BCT-0514L	500
	8	4	FVX5.5-4A		4.3 (.169)	9.5 (.374)	26.7(1.051)	7.5 (.295)						
	10	5	FVX5.5-5A		5.3 (.209)	9.5 (.374)	26.7(1.051)	7.5 (.295)						
	5/16	8	FVX5.5-8A		8.4 (.331)	13.5 (.532)	32.7(1.287)	12.2 (.480)						

- Note:1) The part numbers indicated in the above table are for products with a brazed seam.
When ordering products with a butted seam, add the prefix "WS" to the part number (ex. FVX2-4A → **FVXWS2-4A**).
- 2) *The crimping will be more secure if the total cross-sectional area of the wire is at least 0.5 mm².
Examples: If the cross-sectional area of the wire is 0.3 mm², fold the wire in two when crimping the terminal.
If the cross-sectional area of the wire is 0.5 mm², crimp the terminal onto the wire as it is.
- 3) Delivery lead times may vary depending on the product. Contact JST for details.

Solderless terminals

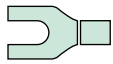

SPADE TONGUE (A type) vinyl-insulated with copper sleeve

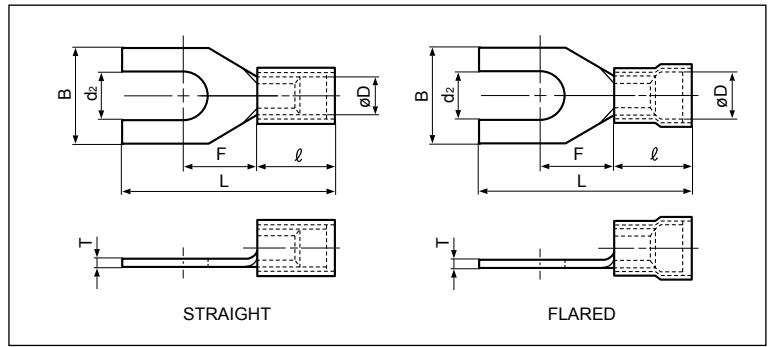
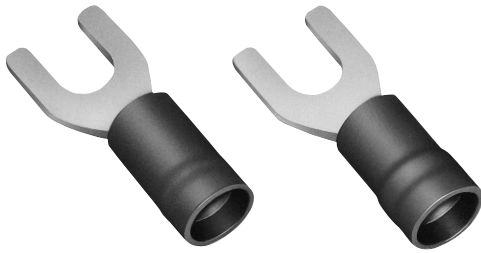
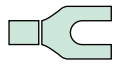

Certificate No.: E42024 LR20812

Applicable Wire AWG#(mm ²)	Stud size		Part No.		Standard	Dimensions mm (in.)								Color	Tool No.	Qty/box
	American	Metric	Straight	Flared		d2	B	L	F	l	ø D		T			
											Str.	Flid.				
26 to 22 (0.2 to 0.5)	3-4	3	VD0.5-3A	—		3.2 (.126)	5.0 (.197)	16.5 (.650)	6.0 (.236)	8.0 (.315)	2.2 (.087)	2.5 (.098)	0.5 (.020)	Yellow	YNT-2622 YA-1,YA-2 BCT-0514L	1,000
	5-6	3.5	VD0.5-3.7A	—		3.7 (.146)	6.4 (.252)	19.0 (.748)	7.7 (.303)	8.3 (.327)						
	5-6	3.5	—	FVD0.5-3.7A		3.7 (.146)	6.4 (.252)	19.3 (.760)	7.7 (.303)	8.3 (.327)						
22 to 16 (0.25 to 1.65)	1-2	2	VD1.25-2A	—		2.2 (.087)	4.6 (.181)	19.4 (.764)	4.3 (.169)	9.6 (.378)	3.5 (.138)	4.0 (.157)	0.8 (.031)	Red	YNT-2216 YA-1 YA-2 YA-4 BCT-0514L	1,000
	3-4	3	VD1.25-B3A	FVD1.25-B3A		3.2 (.126)	5.8 (.228)	20.6 (.811)	6.3 (.248)							
	5-6	3.5	VD1.25-N3A	FVD1.25-N3A		3.7 (.146)	6.2 (.244)	20.6 (.811)	6.3 (.248)							
	5-6	3.5	VD1.25-YS3A	FVD1.25-YS3A		3.7 (.146)	6.4 (.252)	20.2 (.795)	6.3 (.248)							
	5-6	3.5	VD1.25-S3A	FVD1.25-S3A		3.7 (.146)	7.2 (.284)	20.6 (.811)	6.3 (.248)							
	8	4	VD1.25-YS4A	FVD1.25-YS4A		4.3 (.169)	6.4 (.252)	20.2 (.795)	6.3 (.248)							
	8	4	VD1.25-S4A	FVD1.25-S4A		4.3 (.169)	7.2 (.284)	20.6 (.811)	6.3 (.248)							
	8	4	VD1.25-4A	—		4.3 (.169)	8.5 (.335)	20.6 (.811)	7.0 (.276)							
	10	5	VD1.25-S5A	—		5.3 (.209)	7.2 (.284)	20.6 (.811)	6.3 (.248)							
	10	5	VD1.25-M5A	—		5.3 (.209)	8.5 (.335)	20.6 (.811)	7.0 (.276)							
16 to 14 (1.04 to 2.63)	3-4	3	VD2-N3A	FVD2-N3A		3.2 (.126)	5.9 (.232)	20.6 (.811)	6.3 (.248)	9.6 (.378)	4.1 (.161)	4.7 (.185)	0.8 (.031)	Blue	YNT-1614 YA-1 YA-2 YA-4 BCT-0514L	1,000
	3-4	3	VD2-M3A	—		3.2 (.126)	6.0 (.236)	19.3 (.760)	5.0 (.197)							
	5-6	3.5	VD2-YS3A	—		3.7 (.146)	6.4 (.252)	20.2 (.795)	6.3 (.248)							
	5-6	3.5	VD2-S3A	FVD2-S3A		3.7 (.146)	7.2 (.284)	20.8 (.819)	6.5 (.256)							
	5-6	3.5	VD2-3A	—		3.7 (.146)	8.5 (.335)	21.6 (.850)	7.3 (.287)							
	8	4	VD2-YS4A	FVD2-YS4A		4.3 (.169)	6.4 (.252)	20.2 (.795)	6.3 (.248)							
	8	4	VD2-YM4A	FVD2-YM4A		4.3 (.169)	6.8 (.268)	20.2 (.795)	6.3 (.248)							
	8	4	VD2-S4A	FVD2-S4A		4.3 (.169)	7.2 (.284)	20.8 (.819)	6.5 (.256)							
	8	4	VD2-4A	FVD2-4A		4.3 (.169)	8.5 (.335)	21.6 (.850)	7.3 (.287)							
	10	5	VD2-M5A	—		5.3 (.209)	8.5 (.335)	21.6 (.850)	7.3 (.287)							
12 to 10 (2.63 to 6.64)	5-6	3.5	VD5.5-S3A	FVD5.5-S3A		3.7 (.146)	7.2 (.283)	26.7(1.051)	7.5 (.295)	14.0 (.551)	5.7 (.224)	6.5 (.256)	1.0 (.039)	Yellow	YNT-1210S YA-4 BCT-0514L	500
	5-6	3.5	VD5.5-3A	FVD5.5-3A		3.7 (.146)	9.5 (.374)	26.7(1.051)	7.5 (.295)							
	8	4	VD5.5-S4A	FVD5.5-S4A		4.3 (.169)	8.5 (.335)	26.7(1.051)	7.5 (.295)							
	8	4	VD5.5-4A	FVD5.5-4A		4.3 (.169)	9.5 (.374)	26.7(1.051)	7.5 (.295)							
	10	5	VD5.5-5A	FVD5.5-5A		5.3 (.209)	9.5 (.374)	26.7(1.051)	7.5 (.295)							
	1/4	6	VD5.5-6A	FVD5.5-6A		6.4 (.252)	13.5 (.532)	32.7(1.287)	12.2 (.480)							
	5/16	8	VD5.5-8A	—		8.4 (.331)	13.5 (.532)	32.7(1.287)	12.2 (.480)							

Note:1) The part numbers indicated in the above table are for products with a brazed seam.
 When ordering products with a butted seam, add the prefix "WS" to the part number (ex. VD2-4A →VDWS2-4A).
 2) To order products with nylon insulation, change the "V" in the part number prefix to "N" (ex. VD2-4A →ND2-4A).
 Because nylon absorbs moisture, care must be taken concerning storage.
 3) Delivery lead times may vary depending on the product. Contact JST for details.