

SEC' : B-B''

- NOTES
1. MATERIAL : PHOSPHOR BRONZE
0.3mm THICKNESS
 2. FINISH : PRE-PLATED TIN
 3. RECOMMENDED LENGTH OF WIRE STRIP IS 4.0-4.8mm.

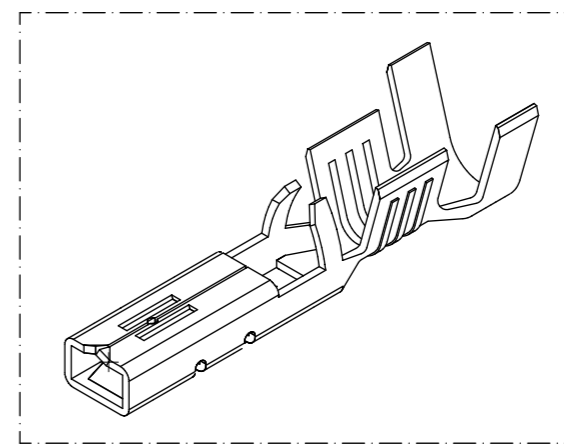

ISOMETRIC VIEW

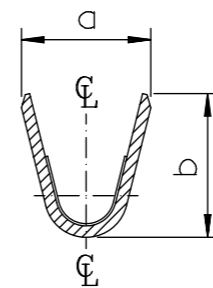
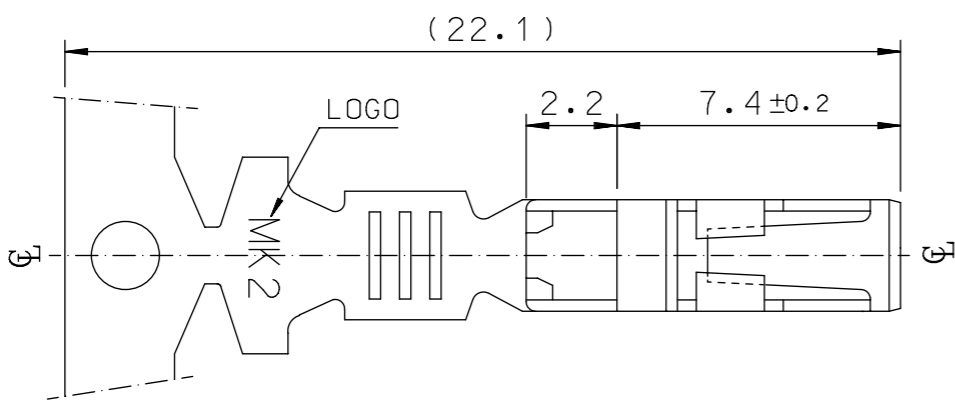
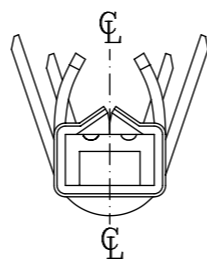
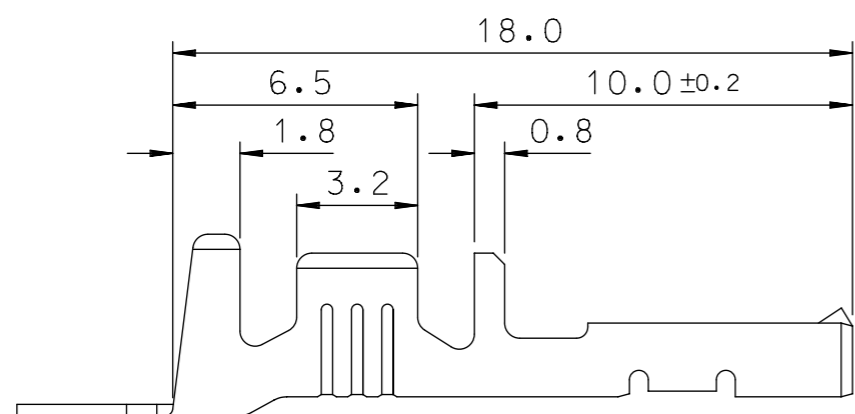

SEC' : C-C''

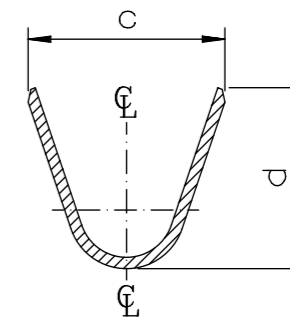

SEC' : D-D''

MATERIAL NO	ENG. No.	AWG	a	b	c	d	P
357480210	35748-0210	#18-#14	3.4	3.8	5.2	4.8	12.0
357480110	35748-0110	#22-#20	2.85	2.8	4.2	4.0	10.6
357480410	35748-0410	#24	2.2	1.75	3.85	3.5	10.6

SYMBOLS DIMENSION UNITS: mm SCALE: 5:1 GENERAL TOLERANCES (UNLESS SPECIFIED): ANGULAR TOL ± 1.0° 4 PLACES ± 3 PLACES ± 2 PLACES ± 0.3 1 PLACE ± 0.3 0 PLACES ± DRAFT WHERE APPLICABLE MUST REMAIN WITHIN DIMENSIONS THIRD ANGLE PROJECTION	THIS DRAWING CONTAINS INFORMATION THAT IS PROPRIETARY TO MOLEX ELECTRONIC TECHNOLOGIES, LLC AND SHOULD NOT BE USED WITHOUT WRITTEN PERMISSION CURRENT REV DESC: EC NO: 605910 DRWN: JSSHIN 2018/10/11 CHK'D: SHCHU 2018/10/15 APPR: YSKIM02 2018/10/16 INITIAL REVISION: DRWN: BKCHOI 1992/11/17 APPR: CWLEE 1992/11/17		 .070 FEMALE TERMINAL (B-TYPE) PRODUCT CUSTOMER DRAWING	
	DOCUMENT NUMBER: SD-35748-001 DOC TYPE: PSD DOC PART: 001 REVISION: F2	MATERIAL NUMBER: SEE TABLE CUSTOMER: GENERAL MARKET SHEET NUMBER: 1 OF 1		

DOCUMENT STATUS	RELEASE DATE
-----------------	--------------

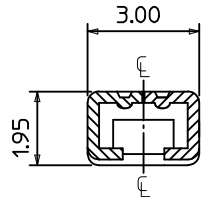
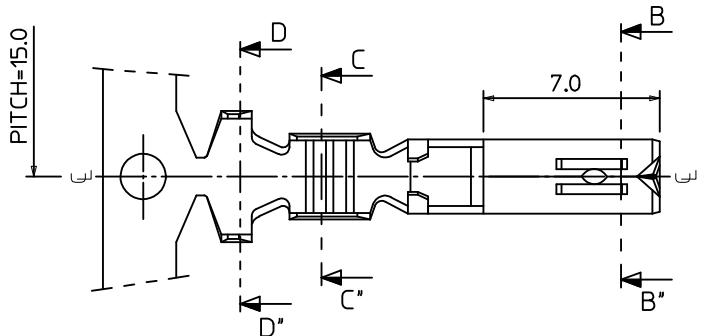

SEC' : B-B'

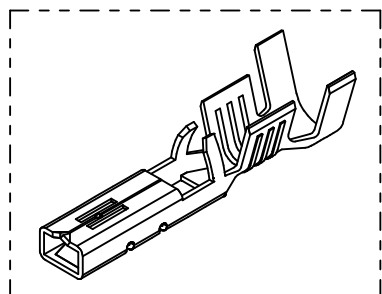
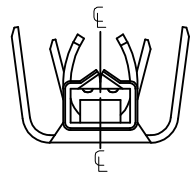
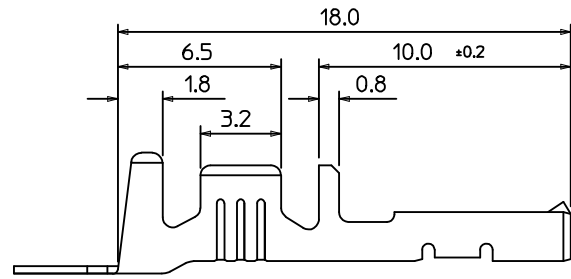

ISOMETRIC VIEW

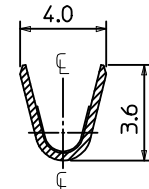
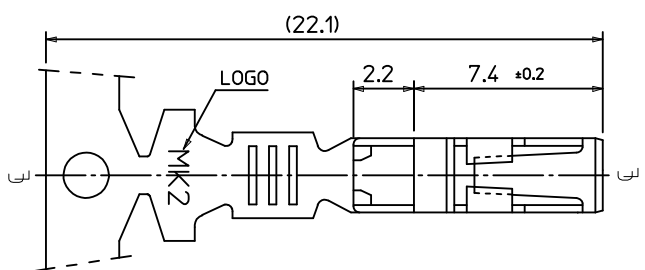

SEC' : C-C'

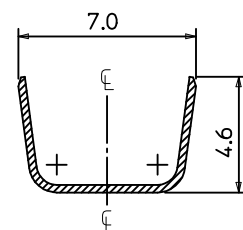

SEC' : D-D'

NOTES

1. MATERIAL : PHOSPHOR BRONZE
0.3mm THICKNESS
2. FINISH : PRE-PLATED TIN
3. RECOMMENDED LENGTH OF WIRE STRIP IS 4.0-4.8mm.
- ④ 4. APPLICABLE WIRE SIZE : AWG #20+#20
AWG #20+#18
AWG #18+#18

REVISED EC NO: KOR2016-0060 DRWN: JSSHIN 2015/12/24 CHKD: SHCHU 2015/12/28 APPR: YSK1M02 2015/12/30	DESCRIPTION 1	QUALITY SYMBOLS	GENERAL TOLERANCES (UNLESS SPECIFIED)	DIMENSION STYLE	SCALE	DESIGN UNITS	THIRD ANGLE PROJECTION																		
		$\nabla=0$ $\sphericalangle=0$	<table border="1"> <tr> <th></th> <th>mm</th> <th>INCH</th> </tr> <tr> <td>4 PLACES</td> <td>± ---</td> <td>± ---</td> </tr> <tr> <td>3 PLACES</td> <td>± ---</td> <td>± ---</td> </tr> <tr> <td>2 PLACES</td> <td>± 0.3</td> <td>± ---</td> </tr> <tr> <td>1 PLACE</td> <td>± 0.3</td> <td>± ---</td> </tr> </table>		mm	INCH	4 PLACES	± ---	± ---	3 PLACES	± ---	± ---	2 PLACES	± 0.3	± ---	1 PLACE	± 0.3	± ---	MM ONLY	5:1	METRIC				
			mm	INCH																					
		4 PLACES	± ---	± ---																					
3 PLACES	± ---	± ---																							
2 PLACES	± 0.3	± ---																							
1 PLACE	± 0.3	± ---																							
DRAFT WHERE APPLICABLE MUST REMAIN WITHIN DIMENSIONS	<table border="1"> <tr> <td>DRAWN BY</td> <td>DATE</td> <td>TITLE</td> </tr> <tr> <td>BKCH01</td> <td>1992/11/17</td> <td rowspan="2">.070 FEMALE TERMINAL (B-TYPE)</td> </tr> <tr> <td>CHECKED BY</td> <td>DATE</td> </tr> <tr> <td>BKCH01</td> <td>1992/11/17</td> <td></td> </tr> <tr> <td>APPROVED BY</td> <td>DATE</td> <td></td> </tr> <tr> <td>YSK1M02</td> <td>2015/12/30</td> <td></td> </tr> </table>	DRAWN BY	DATE	TITLE	BKCH01	1992/11/17	.070 FEMALE TERMINAL (B-TYPE)	CHECKED BY	DATE	BKCH01	1992/11/17		APPROVED BY	DATE		YSK1M02	2015/12/30		<table border="1"> <tr> <td>MATERIAL NO.</td> <td>DOCUMENT NO.</td> <td>SHEET NO.</td> </tr> <tr> <td>357480310</td> <td>SD-35748-003</td> <td>1 OF 1</td> </tr> </table>	MATERIAL NO.	DOCUMENT NO.	SHEET NO.	357480310	SD-35748-003	1 OF 1
DRAWN BY	DATE	TITLE																							
BKCH01	1992/11/17	.070 FEMALE TERMINAL (B-TYPE)																							
CHECKED BY	DATE																								
BKCH01	1992/11/17																								
APPROVED BY	DATE																								
YSK1M02	2015/12/30																								
MATERIAL NO.	DOCUMENT NO.	SHEET NO.																							
357480310	SD-35748-003	1 OF 1																							
			THIS DRAWING CONTAINS INFORMATION THAT IS PROPRIETARY TO MOLEX INCORPORATED AND SHOULD NOT BE USED WITHOUT WRITTEN PERMISSION																						