

42511-2 ✓ ACTIVE

FASTON | FASTON 250

TE Internal #: 42511-2

Quick Disconnects, Receptacle, 18 – 12 AWG Wire Size, .82 – 3.31 mm² Wire Size, Mating Tab Width .25 in [6.35 mm], Flag, Brass, FASTON 250

[View on TE.com >](#)



Terminals & Splices > Quick Disconnects

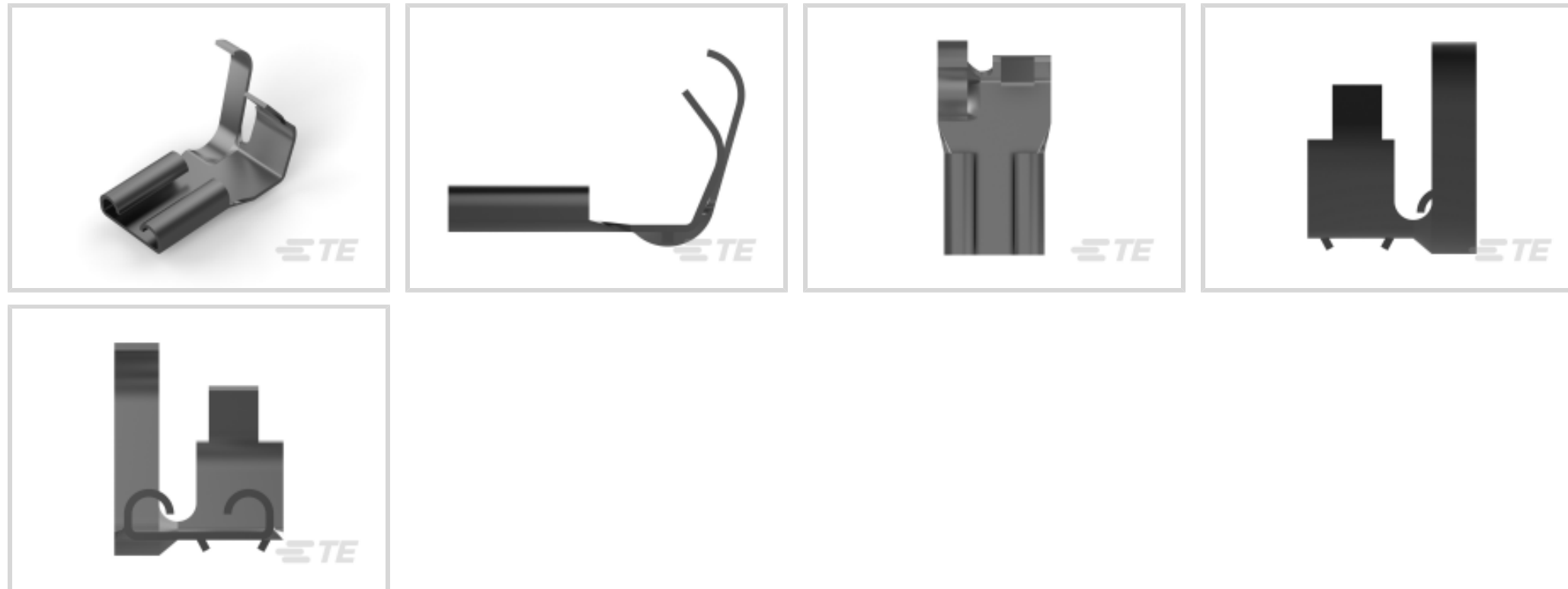

Quick Disconnect Terminal Type: **Receptacle**

Wire Size: .82 – 3.31 mm²

Mating Tab Width: 6.35 mm [.25 in]

Mating Tab Thickness: .81 mm [.032 in]

Features

Product Type Features

Terminates To	Wire & Cable
Wire/Cable Type	Regular Wire
Wire Stop	No
Insertion Force	Low
Sealable	No

Configuration Features

Connection Capacity	Single
---------------------	--------

Contact Features

Quick Disconnect Terminal Type	Receptacle
Mating Tab Width	6.35 mm [.25 in]
Mating Tab Thickness	.81 mm [.032 in]
Terminal Orientation	Flag
Contact Base Material	Brass
Terminal Plating Material	Tin
Crimp Type	Tab-Lok



Barrel Type	Open
-------------	------

Mechanical Attachment

Mating Retention Type	Dimple
	.04 in

Wire Insulation Support	With
-------------------------	------

Dimensions

Accepts Wire Insulation Diameter Range	2.79 – 5.33 mm [.11 – .21 in]
--	-------------------------------

Receptacle Terminal Stock Thickness	.41 mm [.016 in]
-------------------------------------	------------------

Overall Length	17.02 mm [.67 in]
----------------	-------------------

Wire Size	.82 – 3.31 mm ²
-----------	----------------------------

Usage Conditions

Insulation Option	Uninsulated
-------------------	-------------

Operating Temperature Range	-40 – 110 °C [-40 – 230 °F]
-----------------------------	-----------------------------

Industry Standards

CSA Certified	Yes
---------------	-----

UL Rating	Listed
-----------	--------

Packaging Features

Packaging Quantity	4000
--------------------	------

Packaging Method	Strip/Reel
------------------	------------

Other

Line	Budget
------	--------

Product Compliance

[For compliance documentation, visit the product page on TE.com>](#)

EU RoHS Directive 2011/65/EU	Compliant
------------------------------	-----------

EU ELV Directive 2000/53/EC	Compliant
-----------------------------	-----------

China RoHS 2 Directive MIIT Order No 32, 2016	No Restricted Materials Above Threshold
---	---

EU REACH Regulation (EC) No. 1907/2006	Current ECHA Candidate List: JUNE 2022 (224) Candidate List Declared Against: JAN 2022 (223) SVHC > Threshold: Not Yet Reviewed
--	--

Halogen Content	Low Halogen - Br, Cl, F, I < 900 ppm per
-----------------	--

homogenous material. Also BFR/CFR/PVC Free

Solder Process Capability

Not applicable for solder process capability

Product Compliance Disclaimer

This information is provided based on reasonable inquiry of our suppliers and represents our current actual knowledge based on the information they provided. This information is subject to change. The part numbers that TE has identified as EU RoHS compliant have a maximum concentration of 0.1% by weight in homogenous materials for lead, hexavalent chromium, mercury, PBB, PBDE, DBP, BBP, DEHP, DIBP, and 0.01% for cadmium, or qualify for an exemption to these limits as defined in the Annexes of Directive 2011/65/EU (RoHS2). Finished electrical and electronic equipment products will be CE marked as required by Directive 2011/65/EU. Components may not be CE marked. Additionally, the part numbers that TE has identified as EU ELV compliant have a maximum concentration of 0.1% by weight in homogenous materials for lead, hexavalent chromium, and mercury, and 0.01% for cadmium, or qualify for an exemption to these limits as defined in the Annexes of Directive 2000/53/EC (ELV). Regarding the REACH Regulation, the information TE provides on SVHC in articles for this part number is based on the latest European Chemicals Agency (ECHA) 'Guidance on requirements for substances in articles' posted at this URL: <https://echa.europa.eu/guidance-documents/guidance-on-reach>

Compatible Parts



TE Part # 62418-2
250 FASTON FLAG REC 22-16 AWG TPBR



TE Part # 1852633-1
EAPOHB160TABLOCK1800 LM/G-HINGE BAR



TE Part # 1855041-1
HINDGE BAR F.A. EMPO160TAB1800 LM & G



TE Part # 62011-3
250 FASTON FLAG REC 12-10 AWG BR



TE Part # 687395-5
M HBEAPR160T K



TE Part # 687395-6
HDM HBEAPR160T1800TSA



TE Part # 687395-8
HINGE BAR 9EAPR160T1800 G



TE Part # 7-1855041-7
SPARE PART KIT

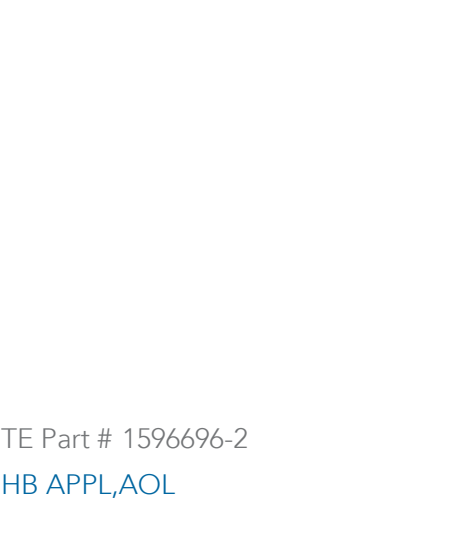

TE Part # 1596696-2
HB APPL,AOL

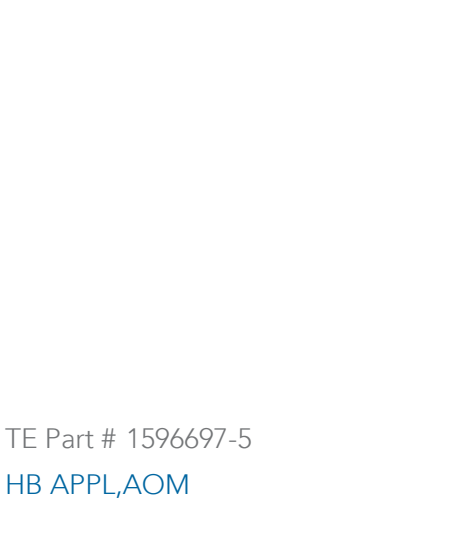

TE Part # 1596697-5
HB APPL,AOM



TE Part # 2088156-2
MINI APPLICATOR, HINGE BAR END FEED



TE Part # 565504-1
STD HBEMPR160T1800K



Also in the Series | FASTON 250

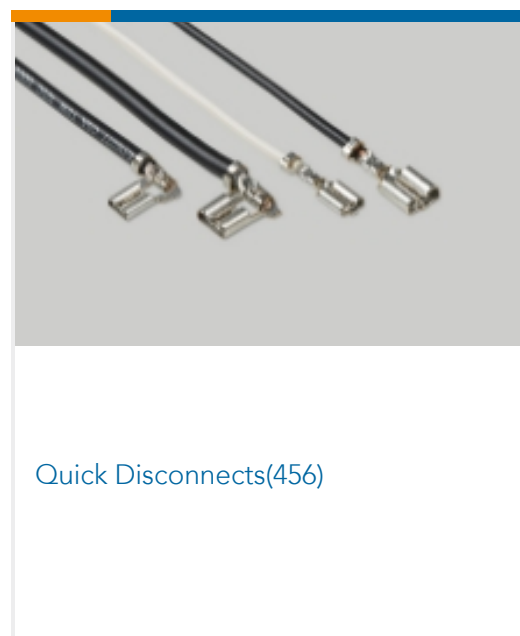
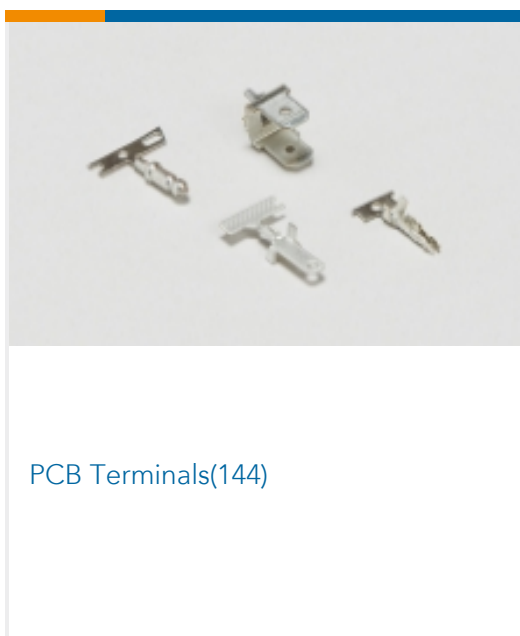
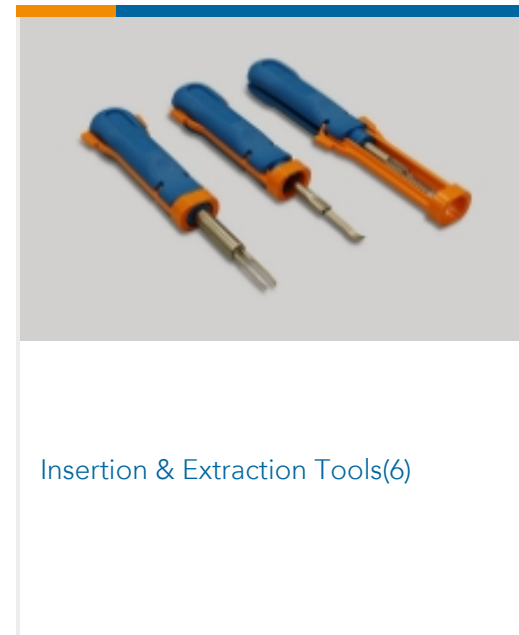
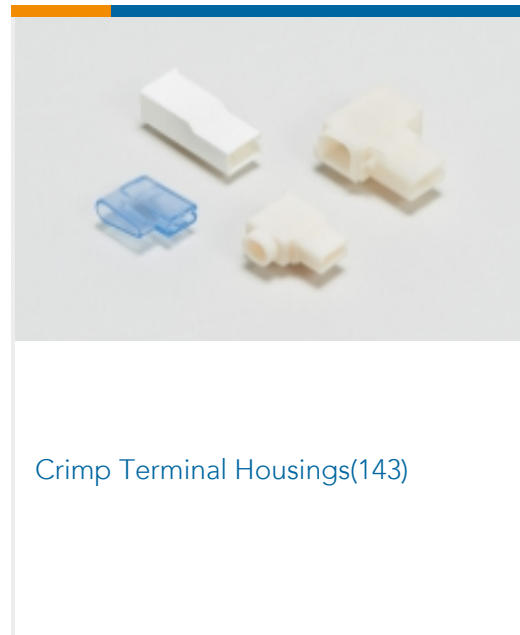
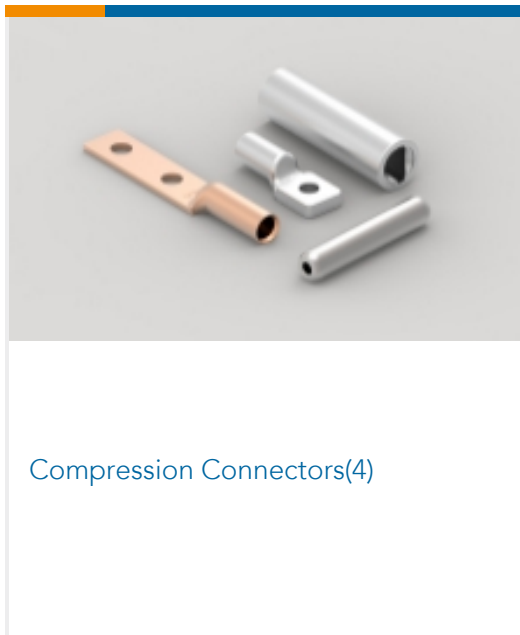

Customers Also Bought



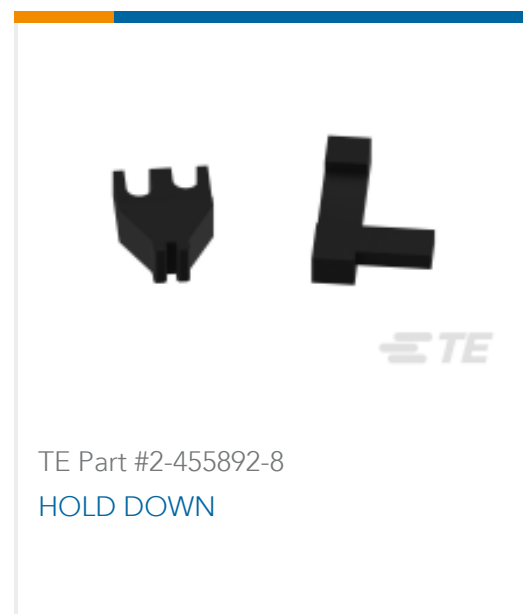

Documents

Product Drawings

[250 FASTON FLAG REC 18-12 AWG TPBR](#)

English

CAD Files

Customer View Model

[ENG_CVM_CVM_42511-2_CB.2d_dxf.zip](#)

English

[3D PDF](#)

3D

Customer View Model

[ENG_CVM_CVM_42511-2_CB.3d_igs.zip](#)

English

Customer View Model

[ENG_CVM_CVM_42511-2_CB.3d_stp.zip](#)

English

By downloading the CAD file I accept and agree to the [Terms and Conditions](#) of use.

Datasheets & Catalog Pages

[82004 FASTON Terminals \(Insulated and Uninsulated\) Catalog - FASTON Receptacles Section](#)

English

Product Specifications

[Engineering Report](#)

English

Product Environmental Compliance

[MD_42511-2_03052018159_dmtec](#)

English

[MD_42511-2_03052018159_dmtec](#)

English

Agency Approvals

[CSA Certificate](#)

English

[CSA Certificate](#)

42511-2

Quick Disconnects, Receptacle, 18 – 12 AWG Wire Size, .82 – 3.31 mm² Wire Size,
Mating Tab Width .25 in [6.35 mm], Flag, Brass, FASTON 250



English