

368354-5 ✓ ACTIVE

### Junior Power Timer

TE Internal #: 368354-5

TE Internal Description: JPT 2P ASSY FOR CLIP GRAY  
TIMER, CONNECTOR HOUSING

[View on TE.com >](#)



### All TIMER, CONNECTOR HOUSING (543)

### Product Compliance

[For compliance documentation, visit the product page on TE.com>](#)

EU RoHS Directive 2011/65/EU	Compliant
EU ELV Directive 2000/53/EC	Compliant
China RoHS 2 Directive MIIT Order No 32, 2016	No Restricted Materials Above Threshold
EU REACH Regulation (EC) No. 1907/2006	Current ECHA Candidate List: JUNE 2022 (224) Candidate List Declared Against: JAN 2022 (223) SVHC > Threshold: Not Yet Reviewed
Halogen Content	Not Low Halogen - contains Br or Cl > 900 ppm.
Solder Process Capability	Not applicable for solder process capability

#### Product Compliance Disclaimer

This information is provided based on reasonable inquiry of our suppliers and represents our current actual knowledge based on the information they provided. This information is subject to change. The part numbers that TE has identified as EU RoHS compliant have a maximum concentration of 0.1% by weight in homogenous materials for lead, hexavalent chromium, mercury, PBB, PBDE, DBP, BBP, DEHP, DIBP, and 0.01% for cadmium, or qualify for an exemption to these limits as defined in the Annexes of Directive 2011/65/EU (RoHS2). Finished electrical and electronic equipment products will be CE marked as required by Directive 2011/65/EU. Components may not be CE marked. Additionally, the part numbers that TE has identified as EU ELV compliant have a maximum concentration of 0.1% by weight in homogenous materials for lead, hexavalent chromium, and mercury, and 0.01% for cadmium, or qualify for an exemption to these limits as defined in the Annexes of Directive 2000/53/EC (ELV). Regarding the REACH Regulation, the information TE provides on SVHC in articles for this part number is based on the latest European Chemicals Agency (ECHA) 'Guidance on requirements for substances in articles' posted at this URL: <https://echa.europa.eu/guidance-documents/guidance-on-reach>

### Compatible Parts



TE Part # 828905-1  
SINGLE-WIRE-SEAL(5MM HOLE)



TE Part # 828904-1  
SINGLE WIRE SEAL FOR J.P.T.CON



TE Part # CAT-T4827-T273  
TIMER, RECEPTACLE AND TAB



TE Part # 936458-2  
COVER HSG FOR JPT 2P ASSY

## Also in the Series | Junior Power Timer



Automotive Connector Caps & Covers  
(5)

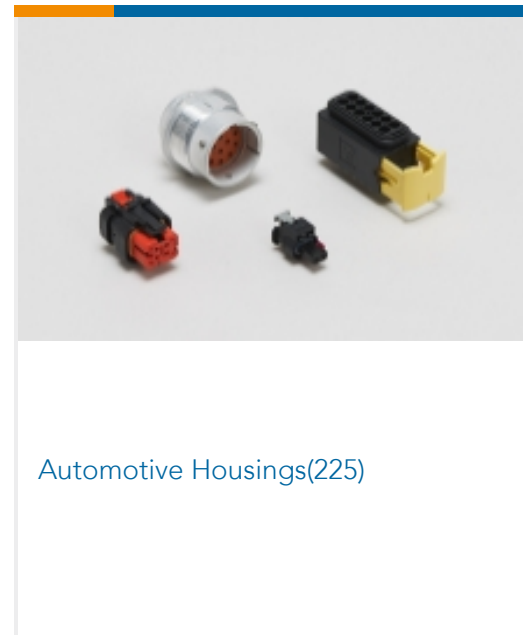

Automotive Housings(225)



Automotive Seals & Cavity Plugs(10)

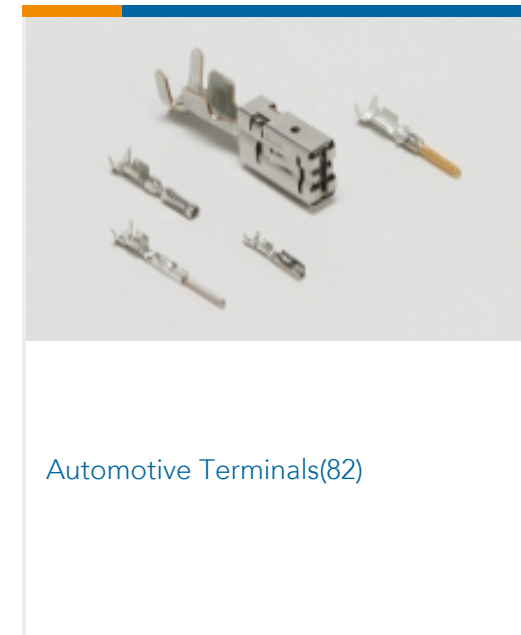

Automotive Terminals(82)

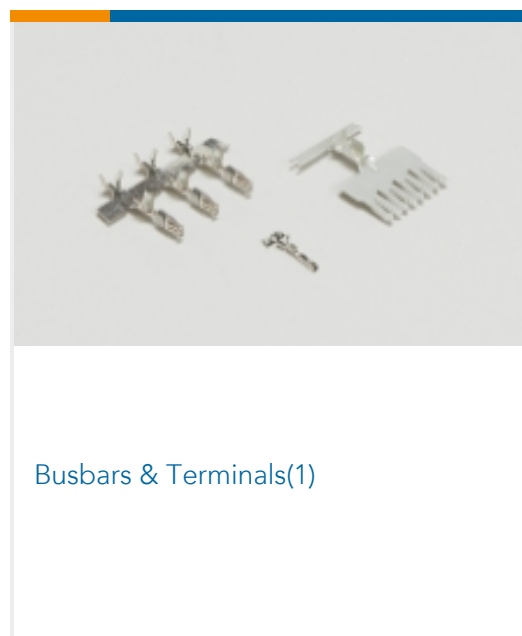

Busbars & Terminals(1)

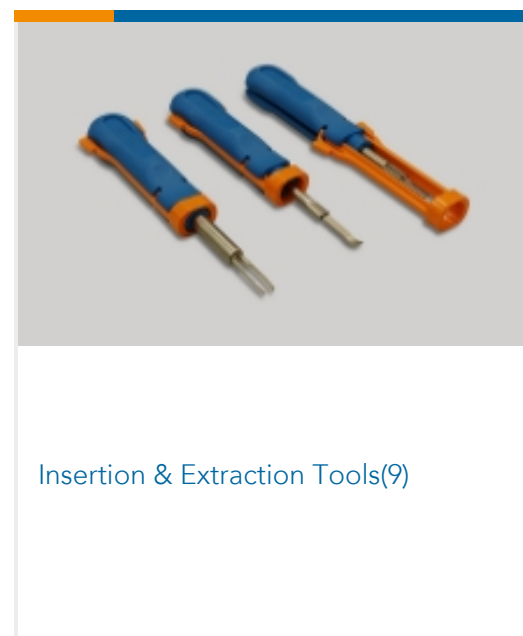

Insertion & Extraction Tools(9)



Module Components(8)

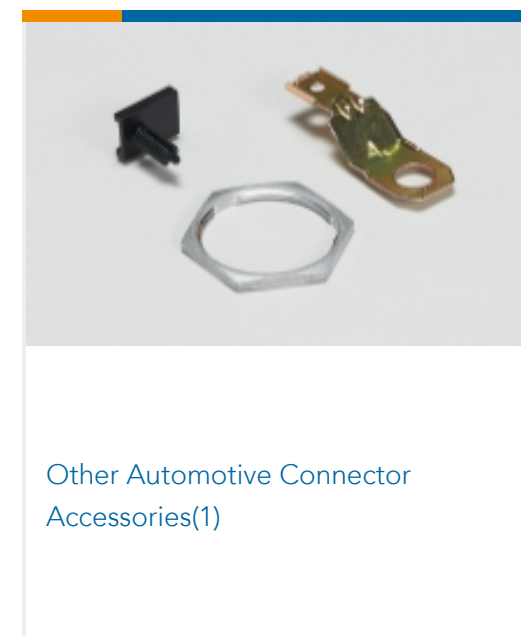

Other Automotive Connector  
Accessories(1)

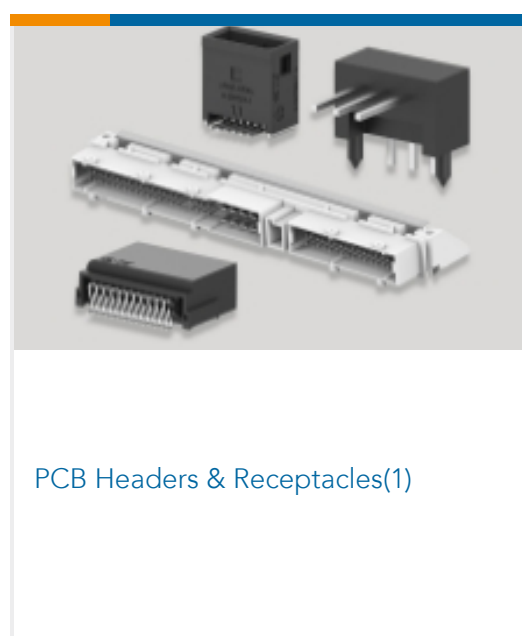

PCB Headers & Receptacles(1)

## Customers Also Bought

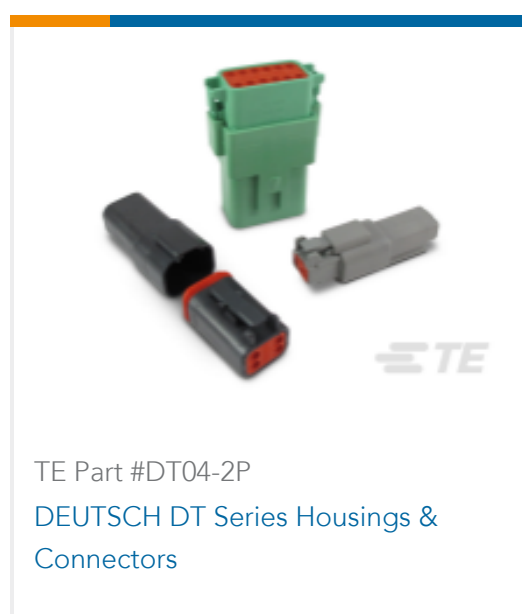

TE Part #DT04-2P  
DEUTSCH DT Series Housings &  
Connectors



TE Part #W2S  
DEUTSCH DT WEDGELOCKS



TE Part #282104-1  
AMP SUPERSEAL 1.5MM,  
CONNECTOR HOUSING

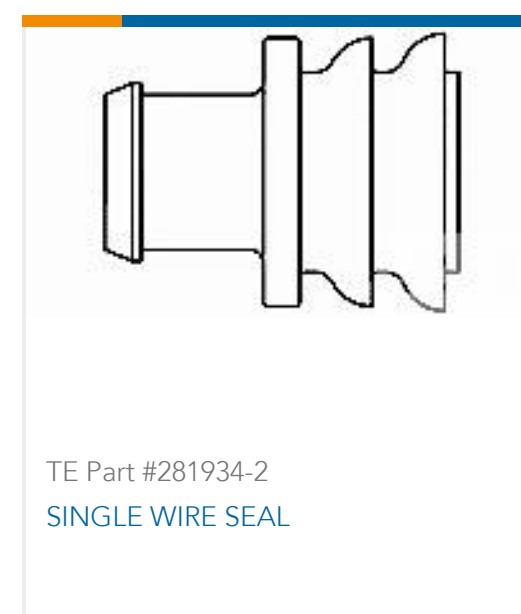

TE Part #281934-2  
SINGLE WIRE SEAL

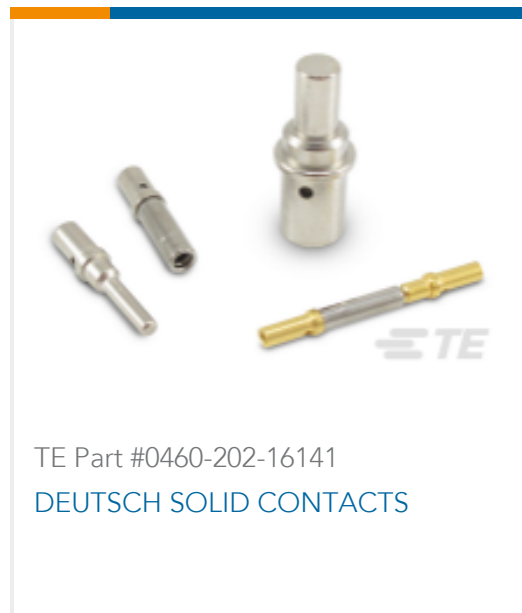

## Documents

### Product Drawings

JPT 2P ASSY FOR CLIP GRAY

English

### CAD Files

Customer View Model

[ENG\\_CVM\\_368354-5\\_C.3d\\_igs.zip](#)

English

Customer View Model

[ENG\\_CVM\\_368354-5\\_C.3d\\_stp.zip](#)

English

Customer View Model

[ENG\\_CVM\\_368354-5\\_C.2d\\_dxf.zip](#)

English

### 3D PDF

English

By downloading the CAD file I accept and agree to the [Terms and Conditions](#) of use.

### Datasheets & Catalog Pages

Timer Interconnection System

English

### Product Specifications

Application Specification

English

### Instruction Sheets

Instruction Sheet (non U.S.)

English