

| AWG: | MAX. INSULATION | "A" ±.012 (±0.30) | "C" ±.012 (±0.30) | "D" ±.005 (±0.13) | "E" ±.012 (±0.30) | "G" ±.005 (±0.13) | "H" ±.012 (±0.30) |
|-------|-----------------|-------------------------|-------------------------|-------------------------|-------------------------|-------------------------|-------------------------|
| 20-24 | .073/(1.85) | .090/(2.29) | .100/(2.54) | .030/(0.76) | .075/(1.91) | .025/(0.64) | .082/(2.08) |
| 26-30 | .050/(1.27) | .075/(1.91) | .083/(2.10) | .025/(0.64) | .058/(1.47) | .020/(0.51) | .065/(1.65) |

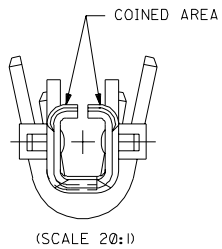
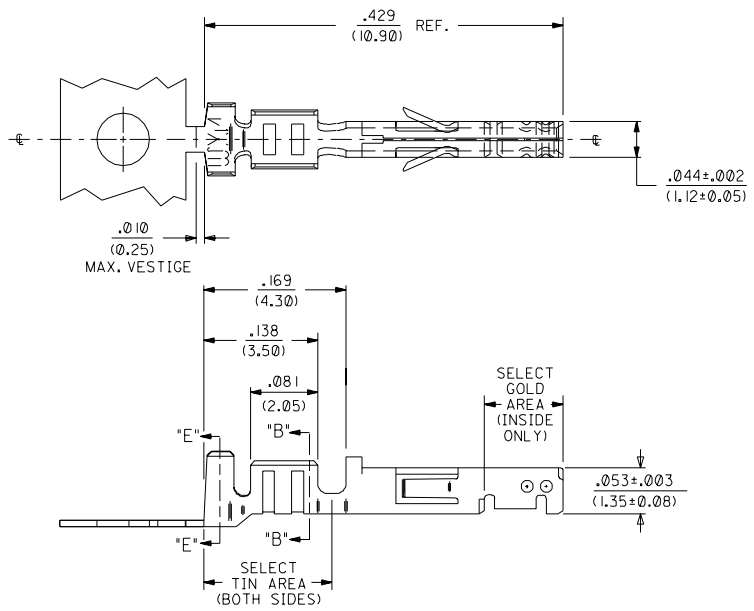
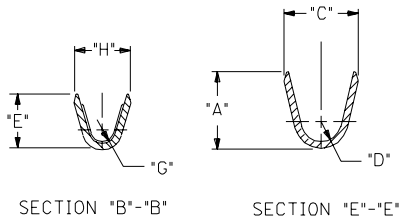

| PREPLATE | | | | BLANK/PLATE/FORM | | | |
|-----------------|---------|-----------|-------|------------------|---------|-----------|-------|
| MATERIAL NUMBER | PLATING | WIRE SIZE | FORM | MATERIAL NUMBER | PLATING | WIRE SIZE | FORM |
| 43030-0001 | A | 20-24 | CHAIN | 43030-0021 | A | 20-24 | CHAIN |
| 43030-0002 | B | 20-24 | CHAIN | 43030-0022 | B | 20-24 | CHAIN |
| 43030-0003 | C | 20-24 | CHAIN | 43030-0023 | C | 20-24 | CHAIN |
| 43030-0004 | A | 26-30 | CHAIN | 43030-0024 | A | 26-30 | CHAIN |
| 43030-0005 | B | 26-30 | CHAIN | 43030-0025 | B | 26-30 | CHAIN |
| 43030-0006 | C | 26-30 | CHAIN | 43030-0026 | C | 26-30 | CHAIN |
| 43030-0007 | A | 20-24 | LOOSE | 43030-0027 | A | 20-24 | LOOSE |
| 43030-0008 | B | 20-24 | LOOSE | 43030-0028 | B | 20-24 | LOOSE |
| 43030-0009 | C | 20-24 | LOOSE | 43030-0029 | C | 20-24 | LOOSE |
| 43030-0010 | A | 26-30 | LOOSE | 43030-0030 | A | 26-30 | LOOSE |
| 43030-0011 | B | 26-30 | LOOSE | 43030-0031 | B | 26-30 | LOOSE |
| 43030-0012 | C | 26-30 | LOOSE | 43030-0032 | C | 26-30 | LOOSE |

NOTES:

- 1) TERMINAL MATERIAL: MODIFIED TIN/BRASS ALLOY
- 2) TERMINAL PLATING:
 - "A"- .000100/(0.0025) MIN TIN/LEAD (90/10) OVER .000050/(0.0013) NICKEL PLATE.
 - "B"- .000015/(0.00038) MIN. GOLD PLATE IN SELECT AREA AND .000050/(0.0013) MIN. TIN/LEAD PLATE (90/10) SELECT AREA WITH MATTE FINISH OVER .000050/(0.0013) MIN. NICKEL OVER-ALL.
 - "C"- .000030/(0.00076) MIN. GOLD PLATE IN SELECT AREA AND .000050/(0.0013) MIN. TIN/LEAD PLATE (90/10) SELECT AREA WITH MATTE FINISH OVER .000050/(0.0013) MIN. NICKEL OVER-ALL.
- 3) THIS TERMINAL IS DESIGNED IN METRIC.
- 4) TERMINAL FOR USE IN RECEPTACLE #43025-****.
- 5) FOR TERMINAL ORIENTATION IN RECEPTACLE SEE DRAWING# SDA-43025.
- 6) PRODUCT SPECIFICATION: PS-43045

| | | | | | | |
|-------------------|--|---|--|---|--|--|
| I | | FINISH CHANGE UCR2001-0059 01-04-24 BURLERSON | DIMENSIONS SHOWN METRIC () INCH UNLESS OTHERWISE SPECIFIED TOLERANCES: ANGULAR ± 1/2° | | ▽ = 0 ▼ = 0 REVISE ONLY ON CAD SYSTEM | |
| H | | MATERIAL CHANGE UCR2001-0567 01-03-01 BURLERSON | INCH METRIC 3 PLACE ± .010 2 PLACE ± .014 ± 0.25 1 PLACE ± 0.35 | | TITLE MICRO-FIT (3.0) FEMALE CRIMP TERMINAL | |
| G | | ADD .053 UCR2000-0183 4-20-00 SAMEC | DRAFT WHERE APPLICABLE MUST REMAIN WITHIN DIMENSIONS | | MOLEX INCORPORATED SHEET NO. 1 OF 1 DATE 93/01/14 LITSEJLL 60532 U.S.A. | |
| LTR. REVISIONS | | LTR. REVISIONS | | PART NO. DRWG. NO. SD-43030-**** | | |
| APP'D: RAS | | CHK'D: BAP | | FILE NAME DIV. SIZE | | |
| SCALE 10:1 | | SCALE 10:1 | | THIS DRAWING CONTAINS INFORMATION THAT IS PROPRIETARY TO MOLEX INC. AND SHOULD NOT BE USED WITHOUT WRITTEN PERMISSION. | | |

[Products](#)
[New](#)
[Contact Us](#)
[About Us](#)
[Investors](#)
[Jobs](#)
[Languages](#)
[日本語](#)
[한국어](#)
[English](#)
[Español](#)
[Français](#)
[Italiano](#)
[Deutsch](#)
[中文显示](#)
[日本語](#)
[한국어](#)
Datasheet
Terminals P/N
Micro-Fit 3.0™ Crimp Terminal 43030, 20-24 AWG, Reel Tin (Sn)
[\[Home > Products > Terminals P/N > Datasheet \]](#)
[Help](#)

43030-0001

| | |
|-----------------------------------|-----------------|
| Product Name | Micro-Fit, 3.0™ |
| Molex Series | 43030 |
| Gender | Female |
| Wire Size [AWG] | 20, 24, 22 |
| Wire Insulation Diameter-max | 1.85mm (.073") |
| Packaging | Reel |
| Plating Contact | Tin (Sn) |
| Contact Material | Phosphor Bronze |
| Dimension C | 2.29mm (.090") |
| Dimension D | 2.54mm (.100") |
| Dimension E | 1.91mm (.075") |
| Dimension F | 2.08mm (.082") |
| US Distributor | * |
| 990 Catalog Page | J-170 |
| MX01 Catalog Page | F-115 |
| Marketing Series and Version | 43030 |

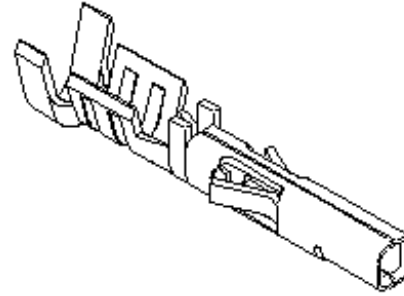

Related Products

Application Tooling

| Part Number | Region | Product Description |
|----------------------------|----------|-----------------------|
| 11-03-0043 | Americas | Extraction Tool |
| 63811-2800 | Americas | Hand Crimper |
| 63850-8100 | Americas | T2 Terminator Die |
| 63860-8100 | Americas | FineAdjust Applicator |
| 69037-1196 | Europe | Mini-Mac Fully Tooled |

[More Application Tooling](#)
Products

Search By:

Enter Molex Part No.

43030-0001

- [Datasheet](#)
- [Request Sample](#)
- [Buy](#)
- [Drawing \(PDF\)](#)

Related Documents

- [Catalog Page \(PDF\)](#)
- [Catalog Page \(HTML\)](#)
- [Product Specification \(PDF\)](#)
- [Product Specification \(PDF\)](#)

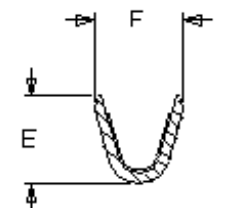
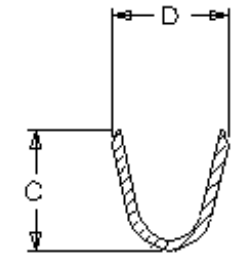
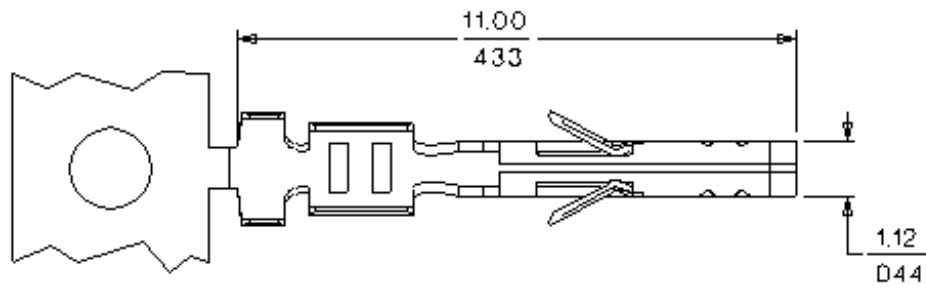

SECTION Z-Z

SECTION Y-Y

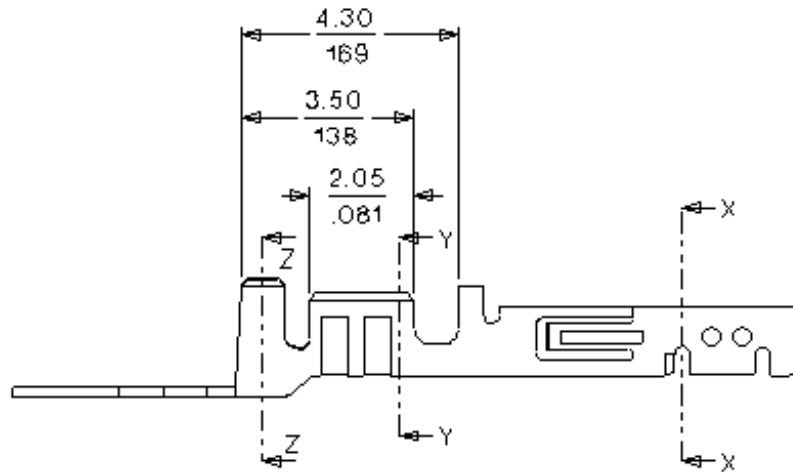

SECTION X-X

[© Copyright 2001 Molex Incorporated]

[Products](#)
[New](#)
[Contact Us](#)
[About Us](#)
[Investors](#)
[Jobs](#)
[Languages](#)
[日本語](#)
[한국어](#)
[English](#)
[Español](#)
[Français](#)
[Italiano](#)
[Deutsch](#)
[中文显示](#)
[日本語](#)
[한국어](#)
Datasheet
Terminals P/N
Micro-Fit 3.0™ Crimp Terminal 43030, 20-24 AWG, Reel Gold (Au)
[\[Home > Products > Terminals P/N > Datasheet \]](#)
[Help](#)

43030-0002

| | |
|-----------------------------------|-----------------|
| Product Name | Micro-Fit, 3.0™ |
| Molex Series | 43030 |
| Gender | Female |
| Wire Size [AWG] | 20, 24, 22 |
| Wire Insulation Diameter-max | 1.85mm (.073") |
| Packaging | Reel |
| Plating Contact | Gold (Au) |
| Plating Thickness | 0.38µm (15µ") |
| Contact Material | Phosphor Bronze |
| Dimension C | 2.29mm (.090") |
| Dimension D | 2.54mm (.100") |
| Dimension E | 1.91mm (.075") |
| Dimension F | 2.08mm (.082") |
| US Distributor | * |
| 990 Catalog Page | J-170 |
| MX01 Catalog Page | F-115 |
| Marketing Series and Version | 43030 |

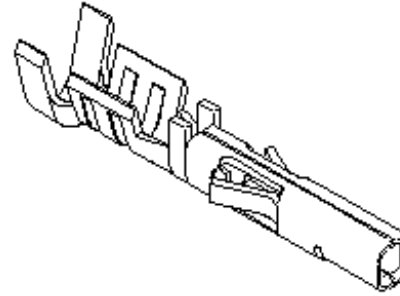

Related Products

Application Tooling

| Part Number | Region | Product Description |
|----------------------------|----------|-----------------------|
| 11-03-0043 | Americas | Extraction Tool |
| 63811-2800 | Americas | Hand Crimper |
| 63850-8100 | Americas | T2 Terminator Die |
| 63860-8100 | Americas | FineAdjust Applicator |
| 69037-1196 | Europe | Mini-Mac Fully Tooled |

[More Application Tooling](#)
Products

Search By:

Enter Molex Part No.

430300002

- [Datasheet](#)
- [Request Sample](#)
- [Buy](#)
- [Drawing \(PDF\)](#)

Related Documents

- [Catalog Page \(PDF\)](#)
- [Catalog Page \(HTML\)](#)
- [Product Specification \(PDF\)](#)
- [Product Specification \(PDF\)](#)

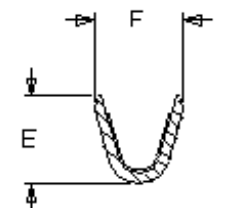
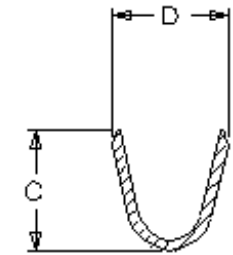
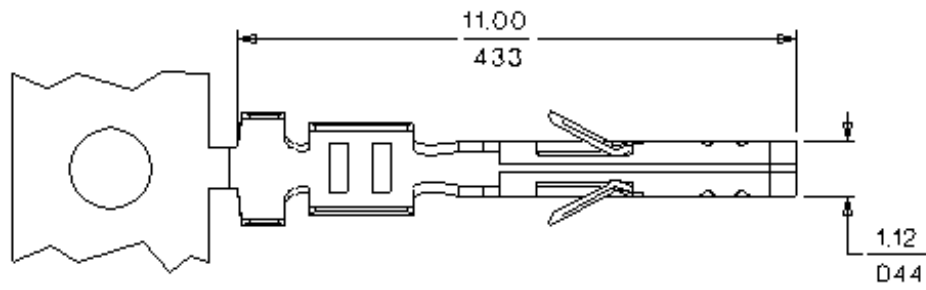

SECTION Z-Z

SECTION Y-Y

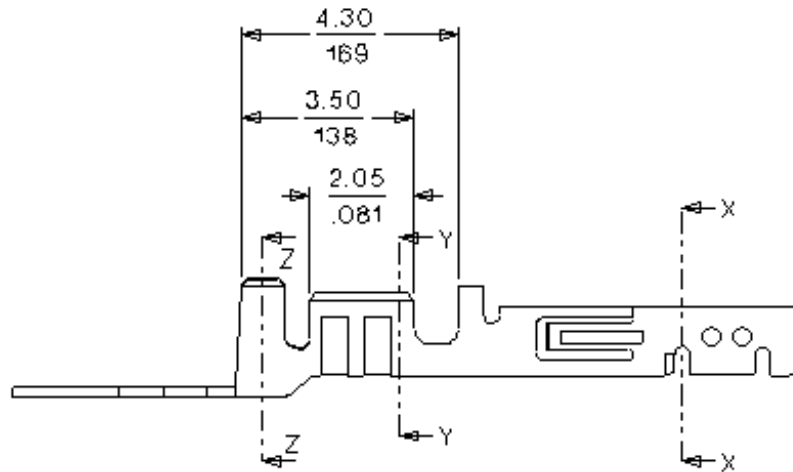

SECTION X-X

[© Copyright 2001 Molex Incorporated]

[Products](#)
[New](#)
[Contact Us](#)
[About Us](#)
[Investors](#)
[Jobs](#)
[Languages](#)
[日本語](#)
[한국어](#)
[English](#)
[Español](#)
[Français](#)
[Italiano](#)
[Deutsch](#)
[中文显示](#)
[日本語](#)
[한국어](#)
Datasheet
Terminals P/N
Micro-Fit 3.0™ Crimp Terminal 43030, 20-24 AWG, Reel Gold (Au)
[\[Home > Products > Terminals P/N > Datasheet \]](#)
[Help](#)

43030-0003

| | |
|-----------------------------------|-----------------|
| Product Name | Micro-Fit, 3.0™ |
| Molex Series | 43030 |
| Gender | Female |
| Wire Size [AWG] | 20, 24, 22 |
| Wire Insulation Diameter-max | 1.85mm (.073") |
| Packaging | Reel |
| Plating Contact | Gold (Au) |
| Plating Thickness | 0.76µm (30µ") |
| Contact Material | Phosphor Bronze |
| Dimension C | 2.29mm (.090") |
| Dimension D | 2.54mm (.100") |
| Dimension E | 1.91mm (.075") |
| Dimension F | 2.08mm (.082") |
| US Distributor | * |
| 990 Catalog Page | J-170 |
| MX01 Catalog Page | F-115 |
| Marketing Series and Version | 43030 |

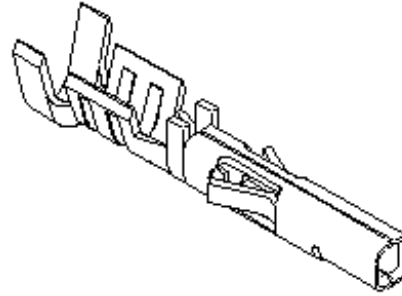

Related Products

Application Tooling

| Part Number | Region | Product Description |
|----------------------------|----------|-----------------------|
| 11-03-0043 | Americas | Extraction Tool |
| 63811-2800 | Americas | Hand Crimper |
| 63850-8100 | Americas | T2 Terminator Die |
| 63860-8100 | Americas | FineAdjust Applicator |
| 69037-1196 | Europe | Mini-Mac Fully Tooled |

[More Application Tooling](#)
Products

Search By:

Enter Molex Part No.

430300003

- [Datasheet](#)
- [Request Sample](#)
- [Buy](#)
- [Drawing \(PDF\)](#)

Related Documents

- [Catalog Page \(PDF\)](#)
- [Catalog Page \(HTML\)](#)
- [Product Specification \(PDF\)](#)
- [Product Specification \(PDF\)](#)

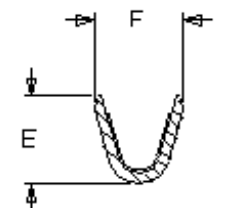
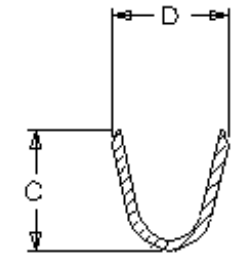
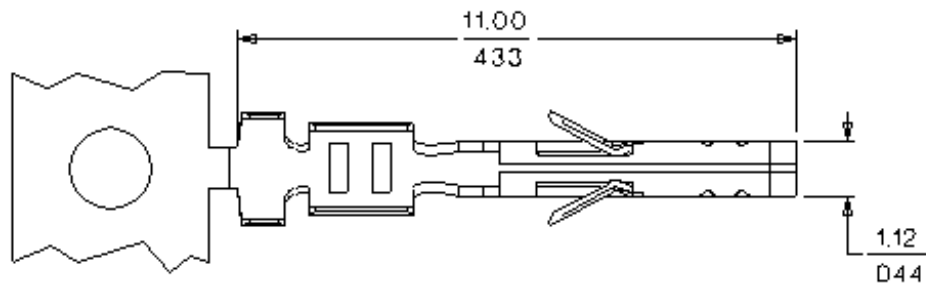

SECTION Z-Z

SECTION Y-Y

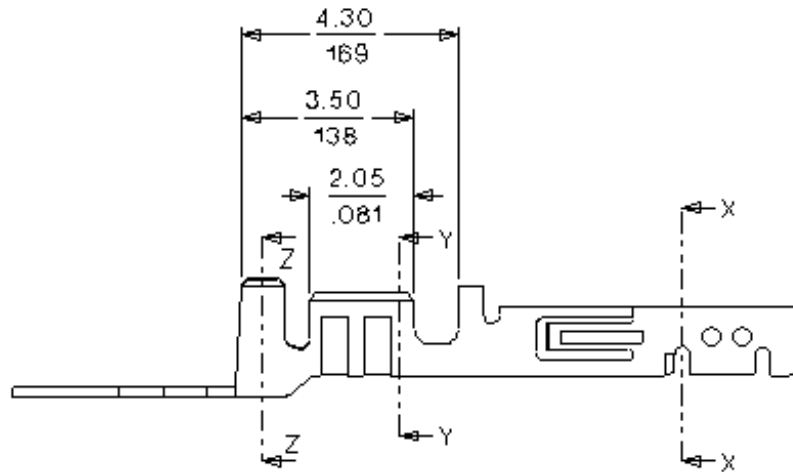

SECTION X-X

[© Copyright 2001 Molex Incorporated]

[Products](#)[New](#)[Contact Us](#)[About Us](#)[Investors](#)[Jobs](#)[Languages](#)[日本語](#)[한국어](#)[English](#)[Español](#)[Français](#)[Italiano](#)[Deutsch](#)[中文显示](#)[日本語](#)[한국어](#)**Datasheet****Terminals P/N****Micro-Fit 3.0™ Crimp Terminal 43030, 26-30 AWG, Reel Tin (Sn)**[\[Home > Products > Terminals P/N > Datasheet \]](#)[Help](#)

43030-0004

| | |
|-----------------------------------|-----------------|
| Product Name | Micro-Fit, 3.0™ |
| Molex Series | 43030 |
| Gender | Female |
| Wire Size [AWG] | 26, 30, 28 |
| Wire Insulation Diameter-max | 1.27mm (.050") |
| Packaging | Reel |
| Plating Contact | Tin (Sn) |
| Contact Material | Phosphor Bronze |
| Dimension C | 1.91mm (.075") |
| Dimension D | 2.10mm (.083") |
| Dimension E | 1.47mm (.058") |
| Dimension F | 1.65mm (.065") |
| US Distributor | * |
| 990 Catalog Page | J-170 |
| MX01 Catalog Page | F-115 |
| Marketing Series and Version | 43030 |

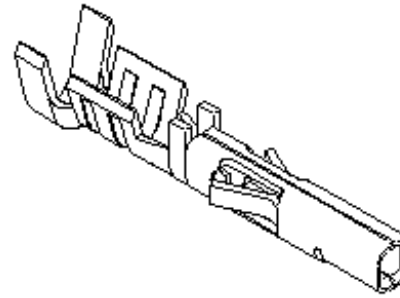

Related Products

Application Tooling

| Part Number | Region | Product Description |
|----------------------------|----------|-----------------------|
| 11-03-0043 | Americas | Extraction Tool |
| 63811-2800 | Americas | Hand Crimper |
| 63850-8000 | Americas | T2 Terminator Die |
| 63860-8000 | Americas | FineAdjust Applicator |
| 69037-1197 | Europe | Mini-Mac Fully Tooled |

[More Application Tooling](#)**Products**

Search By:

Enter Molex Part No.

430300004

- [Datasheet](#)
- [Request Sample](#)
- [Buy](#)
- [Catalog Page \(PDF\)](#)
- [Drawing \(PDF\)](#)

Related Documents

- [Catalog Page \(PDF\)](#)
- [Catalog Page \(HTML\)](#)
- [Product Specification \(PDF\)](#)
- [Product Specification \(PDF\)](#)

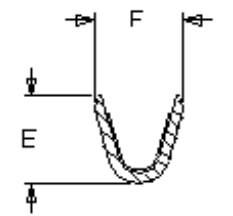
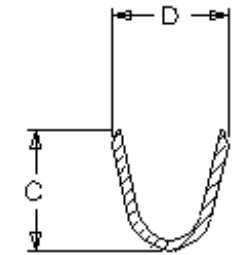
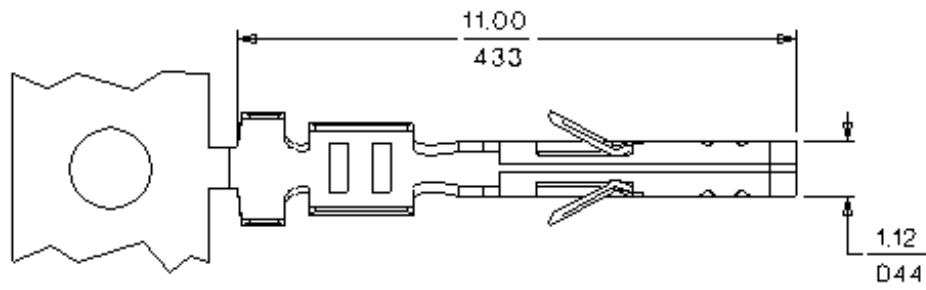

SECTION Z-Z

SECTION Y-Y

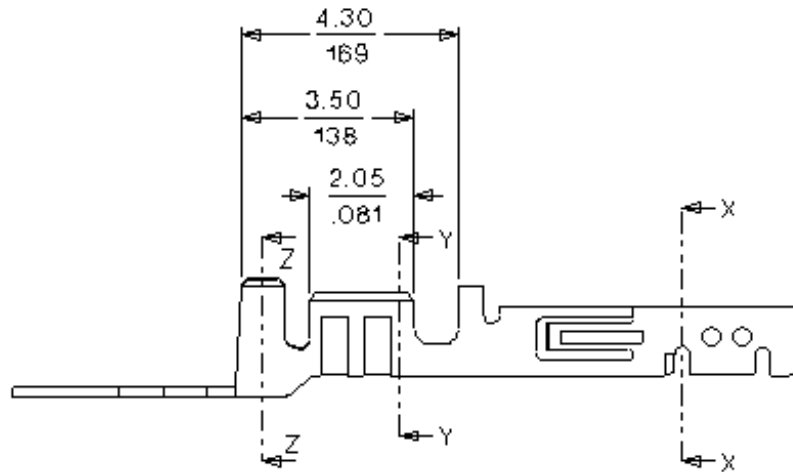

SECTION X-X

[© Copyright 2001 Molex Incorporated]

[Products](#)
[New](#)
[Contact Us](#)
[About Us](#)
[Investors](#)
[Jobs](#)
[Languages](#)
[日本語](#)
[한국어](#)
[English](#)
[Español](#)
[Français](#)
[Italiano](#)
[Deutsch](#)
[中文显示](#)
[日本語](#)
[한국어](#)
[Datasheet](#)
[Terminals P/N](#)
[Micro-Fit 3.0™ Crimp Terminal 43030, 26-30 AWG, Reel Gold \(Au\)](#)
[\[Home > Products > Terminals P/N > Datasheet \]](#)
[Help](#)

43030-0005

| | |
|-----------------------------------|-----------------|
| Product Name | Micro-Fit, 3.0™ |
| Molex Series | 43030 |
| Gender | Female |
| Wire Size [AWG] | 26, 30, 28 |
| Wire Insulation Diameter-max | 1.27mm (.050") |
| Packaging | Reel |
| Plating Contact | Gold (Au) |
| Plating Thickness | 0.38µm (15µ") |
| Contact Material | Phosphor Bronze |
| Dimension C | 1.91mm (.075") |
| Dimension D | 2.10mm (.083") |
| Dimension E | 1.47mm (.058") |
| Dimension F | 1.65mm (.065") |
| US Distributor | * |
| 990 Catalog Page | J-170 |
| MX01 Catalog Page | F-115 |
| Marketing Series and Version | 43030 |

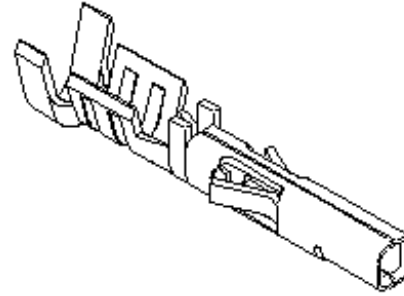

Related Products

Application Tooling

| Part Number | Region | Product Description |
|----------------------------|----------|-----------------------|
| 11-03-0043 | Americas | Extraction Tool |
| 63811-2800 | Americas | Hand Crimper |
| 63850-8000 | Americas | T2 Terminator Die |
| 63860-8000 | Americas | FineAdjust Applicator |
| 69037-1197 | Europe | Mini-Mac Fully Tooled |

[More Application Tooling](#)
[Products](#)

Search By:

Enter Molex Part No.

430300005

- [Datasheet](#)
- [Request Sample](#)
- [Buy](#)
- [Catalog Page \(PDF\)](#)
- [Drawing \(PDF\)](#)

Related Documents

- [Catalog Page \(PDF\)](#)
- [Catalog Page \(HTML\)](#)
- [Product Specification \(PDF\)](#)
- [Product Specification \(PDF\)](#)

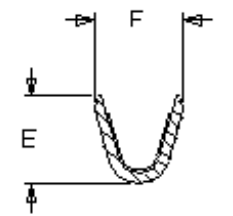
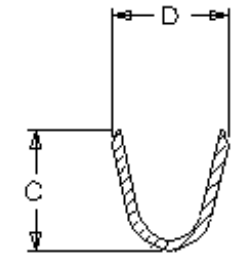
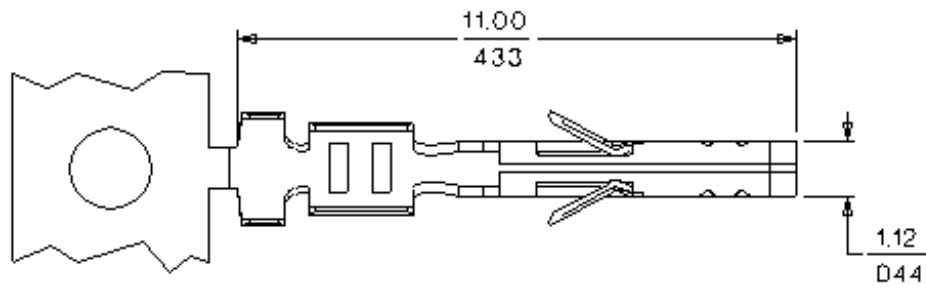

SECTION Z-Z

SECTION Y-Y

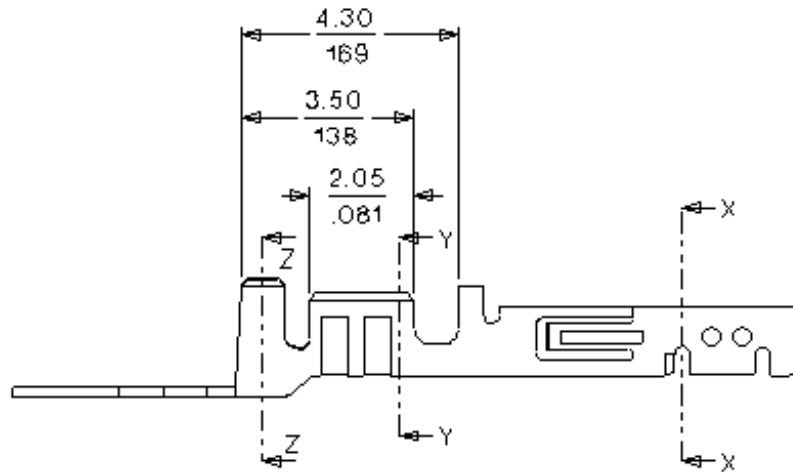

SECTION X-X

[© Copyright 2001 Molex Incorporated]

[Products](#)[New](#)[Contact Us](#)[About Us](#)[Investors](#)[Jobs](#)[Languages](#)[日本語](#)[한국어](#)[English](#)[Español](#)[Français](#)[Italiano](#)[Deutsch](#)[中文显示](#)[日本語](#)[한국어](#)**Datasheet****Terminals P/N****Micro-Fit 3.0™ Crimp Terminal 43030, 26-30 AWG, Reel Gold (Au)**[\[Home > Products > Terminals P/N > Datasheet \]](#)[Help](#)

43030-0006

| | |
|-----------------------------------|-----------------|
| Product Name | Micro-Fit, 3.0™ |
| Molex Series | 43030 |
| Gender | Female |
| Wire Size [AWG] | 26, 30, 28 |
| Wire Insulation Diameter-max | 1.27mm (.050") |
| Packaging | Reel |
| Plating Contact | Gold (Au) |
| Plating Thickness | 0.76µm (30µ") |
| Contact Material | Phosphor Bronze |
| Dimension C | 1.91mm (.075") |
| Dimension D | 2.10mm (.083") |
| Dimension E | 1.47mm (.058") |
| Dimension F | 1.65mm (.065") |
| US Distributor | * |
| 990 Catalog Page | J-170 |
| MX01 Catalog Page | F-115 |
| Marketing Series and Version | 43030 |

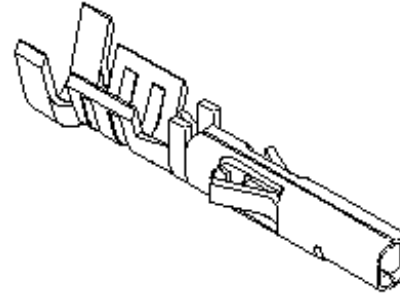

Related Products

Application Tooling

| Part Number | Region | Product Description |
|----------------------------|----------|-----------------------|
| 11-03-0043 | Americas | Extraction Tool |
| 63811-2800 | Americas | Hand Crimper |
| 63850-8000 | Americas | T2 Terminator Die |
| 63860-8000 | Americas | FineAdjust Applicator |
| 69037-1197 | Europe | Mini-Mac Fully Tooled |

[More Application Tooling](#)**Products**

Search By:

Enter Molex Part No.

430300006

- [Datasheet](#)
- [Request Sample](#)
- [Buy](#)
- [Catalog Page \(PDF\)](#)
- [Drawing \(PDF\)](#)

Related Documents

- [Catalog Page \(PDF\)](#)
- [Catalog Page \(HTML\)](#)
- [Product Specification \(PDF\)](#)
- [Product Specification \(PDF\)](#)

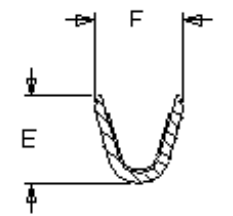
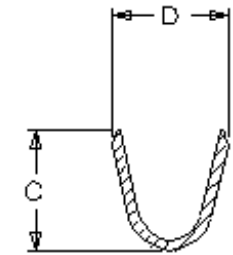
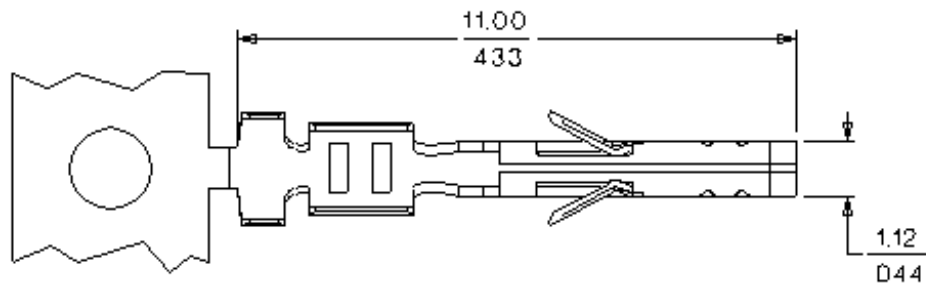

SECTION Z-Z

SECTION Y-Y

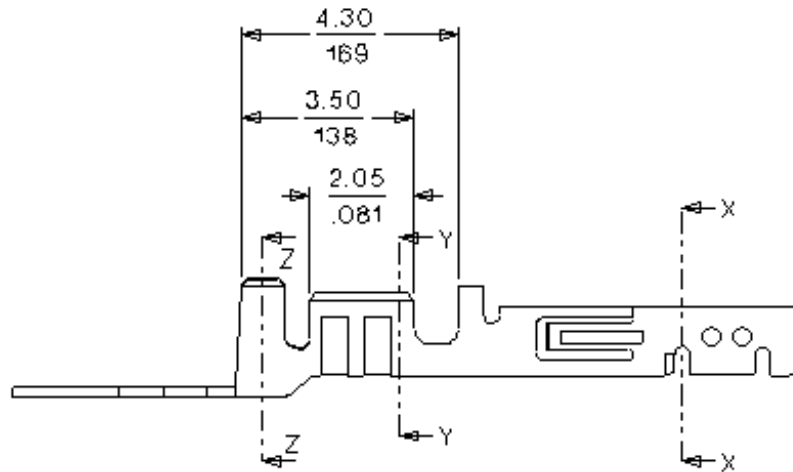

SECTION X-X

[© Copyright 2001 Molex Incorporated]

[Products](#)
[New](#)
[Contact Us](#)
[About Us](#)
[Investors](#)
[Jobs](#)
[Languages](#)
[日本語](#)
[한국어](#)
[English](#)
[Español](#)
[Français](#)
[Italiano](#)
[Deutsch](#)
[中文显示](#)
[日本語](#)
[한국어](#)
Datasheet
Terminals P/N
Micro-Fit 3.0™ Crimp Terminal 43030, 20-24 AWG, Bag Tin (Sn)
[\[Home > Products > Terminals P/N > Datasheet \]](#)
[Help](#)

43030-0007

| | |
|-----------------------------------|-----------------|
| Product Name | Micro-Fit, 3.0™ |
| Molex Series | 43030 |
| Gender | Female |
| Wire Size [AWG] | 20, 24, 22 |
| Wire Insulation Diameter-max | 1.85mm (.073") |
| Packaging | Bag |
| Plating Contact | Tin (Sn) |
| Contact Material | Phosphor Bronze |
| Dimension C | 2.29mm (.090") |
| Dimension D | 2.54mm (.100") |
| Dimension E | 1.91mm (.075") |
| Dimension F | 2.08mm (.082") |
| US Distributor | * |
| 990 Catalog Page | J-170 |
| MX01 Catalog Page | F-115 |
| Marketing Series and Version | 43030 |

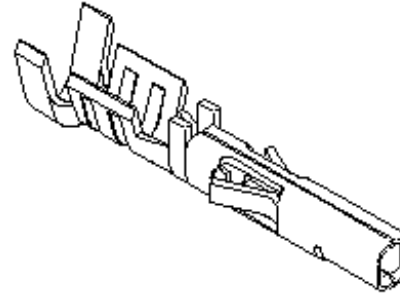

Related Products

Application Tooling

| Part Number | Region | Product Description |
|----------------------------|----------|--------------------------|
| 11-03-0043 | Americas | Extraction Tool |
| 63811-2800 | Americas | Hand Crimper |
| 69008-0982 | Europe | Parallel Action Handtool |

[More Application Tooling](#)
Products

Search By:

Enter Molex Part No.

430300007

- [Datasheet](#)
- [Request Sample](#)
- [Buy](#)
- [Catalog Page \(PDF\)](#)
- [Drawing \(PDF\)](#)

Related Documents

- [Catalog Page \(PDF\)](#)
- [Catalog Page \(HTML\)](#)
- [Product Specification \(PDF\)](#)
- [Product Specification \(PDF\)](#)

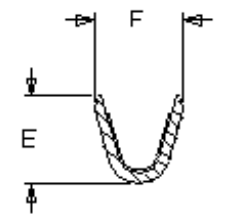
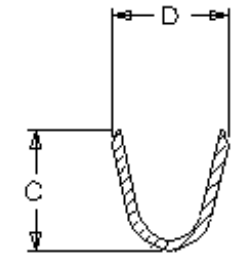
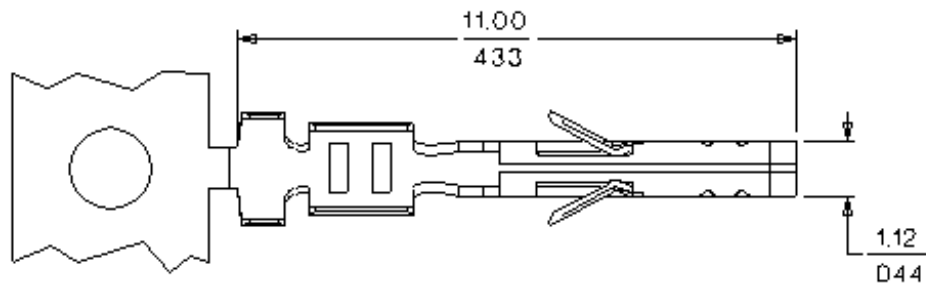

SECTION Z-Z

SECTION Y-Y

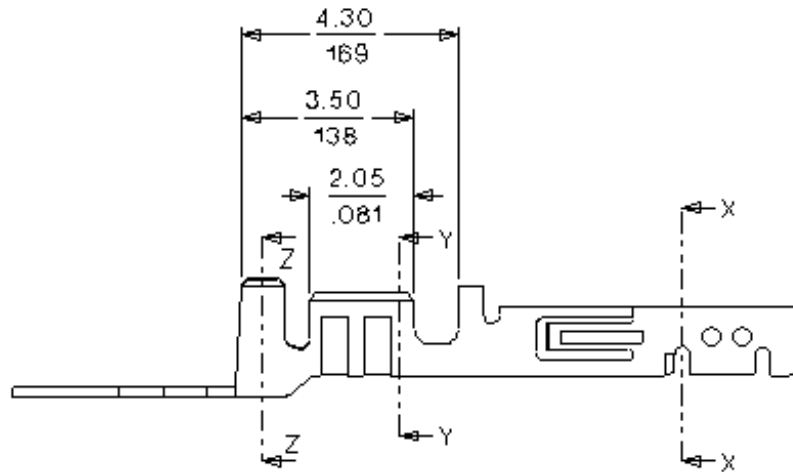

SECTION X-X

[© Copyright 2001 Molex Incorporated]

[Products](#)
[New](#)
[Contact Us](#)
[About Us](#)
[Investors](#)
[Jobs](#)
[Languages](#)
[日本語](#)
[한국어](#)
[English](#)
[Español](#)
[Français](#)
[Italiano](#)
[Deutsch](#)
[中文显示](#)
[日本語](#)
[한국어](#)
[Datasheet](#)
[Terminals P/N](#)
[Micro-Fit 3.0™ Crimp Terminal 43030, 20-24 AWG, Bag Gold \(Au\)](#)
[\[Home > Products > Terminals P/N > Datasheet \]](#)
[Help](#)

43030-0008

| | |
|-----------------------------------|-----------------|
| Product Name | Micro-Fit, 3.0™ |
| Molex Series | 43030 |
| Gender | Female |
| Wire Size [AWG] | 20, 24, 22 |
| Wire Insulation Diameter-max | 1.85mm (.073") |
| Packaging | Bag |
| Plating Contact | Gold (Au) |
| Plating Thickness | 0.38µm (15µ") |
| Contact Material | Phosphor Bronze |
| Dimension C | 2.29mm (.090") |
| Dimension D | 2.54mm (.100") |
| Dimension E | 1.91mm (.075") |
| Dimension F | 2.08mm (.082") |
| US Distributor | * |
| 990 Catalog Page | J-170 |
| MX01 Catalog Page | F-115 |
| Marketing Series and Version | 43030 |

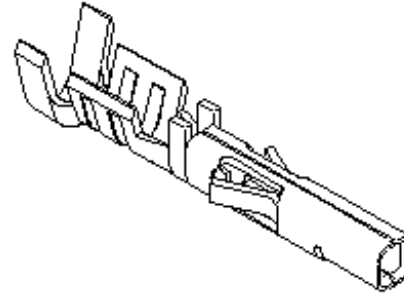

Related Products

Application Tooling

| Part Number | Region | Product Description |
|----------------------------|----------|--------------------------|
| 11-03-0043 | Americas | Extraction Tool |
| 63811-2800 | Americas | Hand Crimper |
| 69008-0982 | Europe | Parallel Action Handtool |

[More Application Tooling](#)
[Products](#)

Search By:

Enter Molex Part No.

430300008

- [Datasheet](#)
- [Request Sample](#)
- [Buy](#)
- [Catalog Page \(PDF\)](#)
- [Drawing \(PDF\)](#)

Related Documents

- [Catalog Page \(PDF\)](#)
- [Catalog Page \(HTML\)](#)
- [Product Specification \(PDF\)](#)
- [Product Specification \(PDF\)](#)

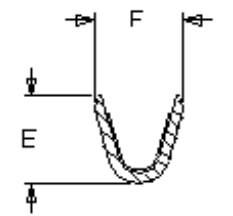
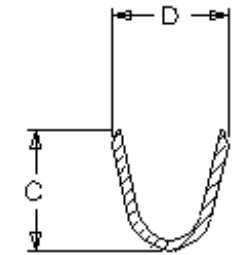
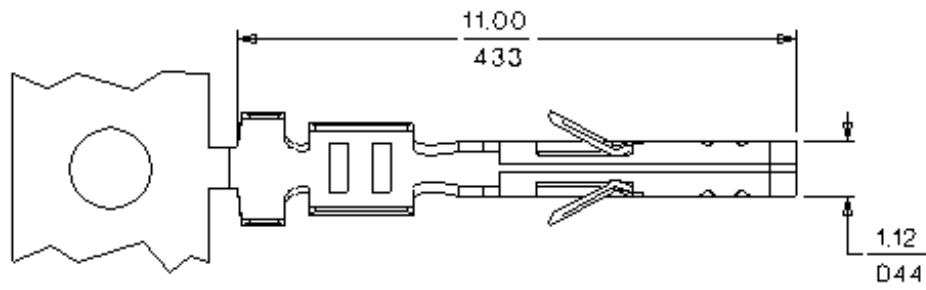

SECTION Z-Z

SECTION Y-Y

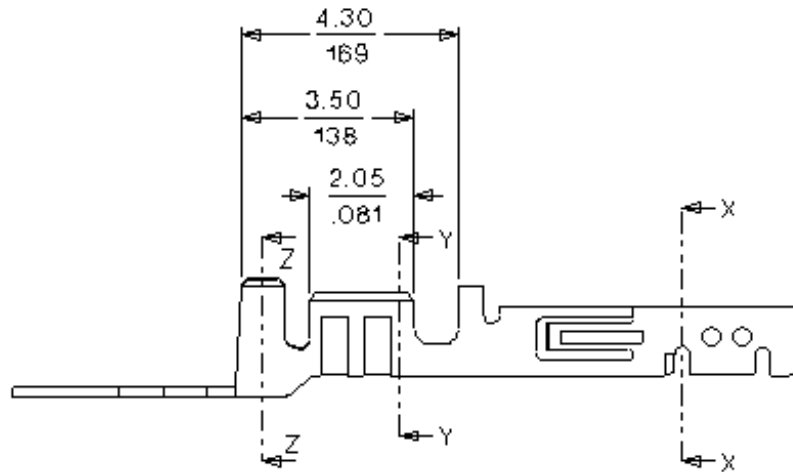

SECTION X-X

[© Copyright 2001 Molex Incorporated]

[Products](#)[New](#)[Contact Us](#)[About Us](#)[Investors](#)[Jobs](#)[Languages](#)[日本語](#)[한국어](#)[English](#)[Español](#)[Français](#)[Italiano](#)[Deutsch](#)[中文显示](#)[日本語](#)[한국어](#)[Datasheet](#)[Terminals P/N](#)[Micro-Fit 3.0™ Crimp Terminal 43030, 20-24 AWG, Bag Gold \(Au\)](#)[\[Home > Products > Terminals P/N > Datasheet \]](#)[Help](#)

43030-0009

| | |
|-----------------------------------|-----------------|
| Product Name | Micro-Fit, 3.0™ |
| Molex Series | 43030 |
| Gender | Female |
| Wire Size [AWG] | 20, 24, 22 |
| Wire Insulation Diameter-max | 1.85mm (.073") |
| Packaging | Bag |
| Plating Contact | Gold (Au) |
| Plating Thickness | 0.76µm (30µ") |
| Contact Material | Phosphor Bronze |
| Dimension C | 2.29mm (.090") |
| Dimension D | 2.54mm (.100") |
| Dimension E | 1.91mm (.075") |
| Dimension F | 2.08mm (.082") |
| US Distributor | * |
| 990 Catalog Page | J-170 |
| MX01 Catalog Page | F-115 |
| Marketing Series and Version | 43030 |

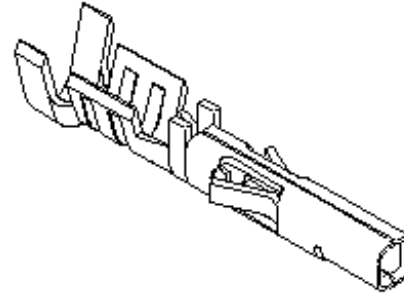

Related Products

Application Tooling

| Part Number | Region | Product Description |
|----------------------------|----------|--------------------------|
| 11-03-0043 | Americas | Extraction Tool |
| 63811-2800 | Americas | Hand Crimper |
| 69008-0982 | Europe | Parallel Action Handtool |

[More Application Tooling](#)[Products](#)

Search By:

Enter Molex Part No.

430300009

- [Datasheet](#)
- [Request Sample](#)
- [Buy](#)
- [Catalog Page \(PDF\)](#)
- [Drawing \(PDF\)](#)

Related Documents

- [Catalog Page \(PDF\)](#)
- [Catalog Page \(HTML\)](#)
- [Product Specification \(PDF\)](#)
- [Product Specification \(PDF\)](#)

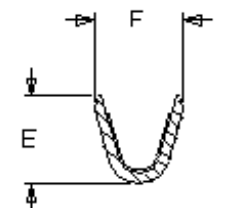
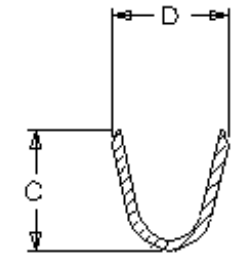
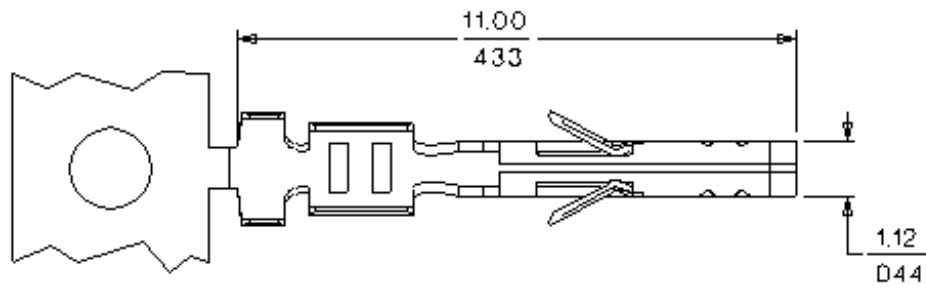

SECTION Z-Z

SECTION Y-Y

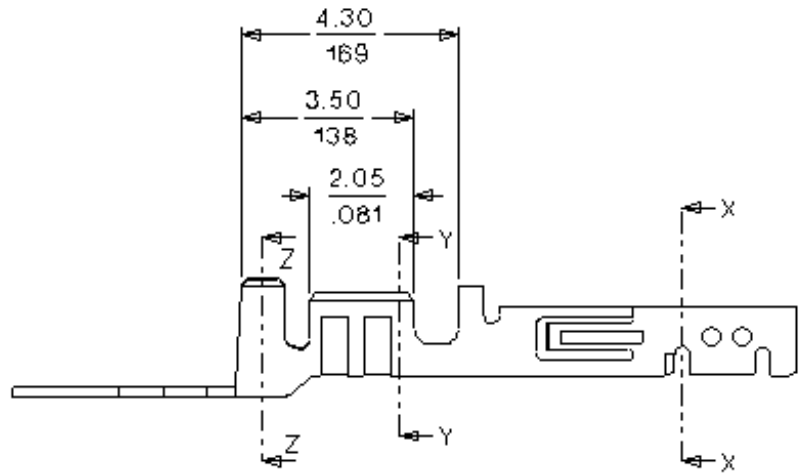

SECTION X-X

[© Copyright 2001 Molex Incorporated]