

42486-1 ✓ ACTIVE

FASTON | FASTON 187

TE Internal #: 42486-1

Quick Disconnects, Receptacle, 20 – 16 AWG Wire Size, .51 – 1.31 mm<sup>2</sup> Wire Size, Mating Tab Width .187 in [4.75 mm], Flag, Brass, FASTON 187

[View on TE.com >](#)



Terminals & Splices > Quick Disconnects



Quick Disconnect Terminal Type: **Receptacle**

Wire Size: .51 – 1.31 mm<sup>2</sup>

Mating Tab Width: 4.75 mm [.187 in]

Mating Tab Thickness: .51 mm [.02 in]

## Features

### Product Type Features

Terminates To	Wire & Cable
Wire/Cable Type	Regular Wire
Wire Stop	No
Insertion Force	Low
Sealable	No

### Configuration Features

Connection Capacity	Single
---------------------	--------

### Contact Features

Quick Disconnect Terminal Type	Receptacle
Mating Tab Width	4.75 mm [.187 in]
Mating Tab Thickness	.51 mm [.02 in]
Terminal Orientation	Flag
Contact Base Material	Brass
Terminal Plating Material	Unplated
Crimp Type	Tab-Lok



Barrel Type	Open
-------------	------

### Mechanical Attachment

Mating Retention Type	Dimple
	.035 in

Wire Insulation Support	With
-------------------------	------

### Dimensions

Accepts Wire Insulation Diameter Range	2.79 – 4.32 mm [.11 – .17 in]
--	-------------------------------

Receptacle Terminal Stock Thickness	.3 mm [.012 in]
-------------------------------------	-----------------

Overall Length	13.46 mm [.53 in]
----------------	-------------------

Wire Size	.51 – 1.31 mm <sup>2</sup>
-----------	----------------------------

### Usage Conditions

Insulation Option	Uninsulated
-------------------	-------------

Operating Temperature Range	-40 – 110 °C [-40 – 230 °F]
-----------------------------	-----------------------------

### Industry Standards

CSA Certified	Yes
---------------	-----

UL Rating	Listed
-----------	--------

### Packaging Features

Packaging Quantity	6000
--------------------	------

Packaging Method	Strip/Reel
------------------	------------

### Other

Line	Premier
------	---------

### Product Compliance

[For compliance documentation, visit the product page on TE.com>](#)

EU RoHS Directive 2011/65/EU	Compliant
------------------------------	-----------

EU ELV Directive 2000/53/EC	Compliant
-----------------------------	-----------

China RoHS 2 Directive MIIT Order No 32, 2016	No Restricted Materials Above Threshold
---	---

EU REACH Regulation (EC) No. 1907/2006	Current ECHA Candidate List: JUNE 2022 (224) Candidate List Declared Against: JUNE 2022 (224) Does not contain REACH SVHC
--	---

Halogen Content	Low Halogen - Br, Cl, F, I < 900 ppm per homogenous material. Also BFR/CFR/PVC
-----------------	--

Free

Solder Process Capability

Not applicable for solder process capability

Product Compliance Disclaimer

This information is provided based on reasonable inquiry of our suppliers and represents our current actual knowledge based on the information they provided. This information is subject to change. The part numbers that TE has identified as EU RoHS compliant have a maximum concentration of 0.1% by weight in homogenous materials for lead, hexavalent chromium, mercury, PBB, PBDE, DBP, BBP, DEHP, DIBP, and 0.01% for cadmium, or qualify for an exemption to these limits as defined in the Annexes of Directive 2011/65/EU (RoHS2). Finished electrical and electronic equipment products will be CE marked as required by Directive 2011/65/EU. Components may not be CE marked. Additionally, the part numbers that TE has identified as EU ELV compliant have a maximum concentration of 0.1% by weight in homogenous materials for lead, hexavalent chromium, and mercury, and 0.01% for cadmium, or qualify for an exemption to these limits as defined in the Annexes of Directive 2000/53/EC (ELV). Regarding the REACH Regulation, the information TE provides on SVHC in articles for this part number is based on the latest European Chemicals Agency (ECHA) 'Guidance on requirements for substances in articles' posted at this URL: <https://echa.europa.eu/guidance-documents/guidance-on-reach>

### Compatible Parts



TE Part # 1217027-1  
187 FASTON,FLAG,REC.,18-14 AWG, TPBR



TE Part # 1-480487-2  
FASTON 187 FLAG HSG NYLON NAT LP



TE Part # 1-687392-9  
HB 9EAPR140T140O G



TE Part # 1855654-1  
HDM/FA HBEMPO140T140O LM CUT



TE Part # 565501-1  
STD HBEMPR140T140OK



TE Part # 567758-1  
APPL,HB\*CQM\* 8EAPR140T140O G

### Also in the Series | FASTON 187

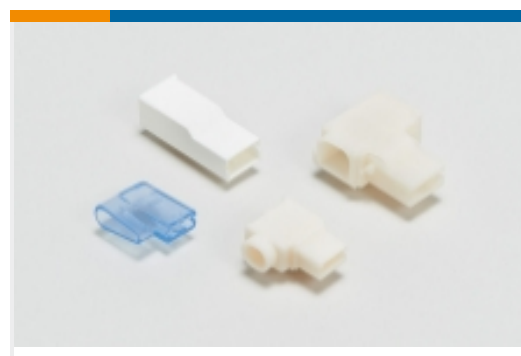

Crimp Terminal Housings(41)



Insertion & Extraction Tools(1)



Joints & Splices(1)



PCB Terminals(48)



Quick Disconnects(214)



Splices(1)

## Customers Also Bought

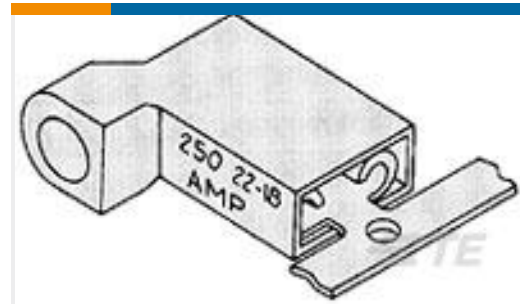
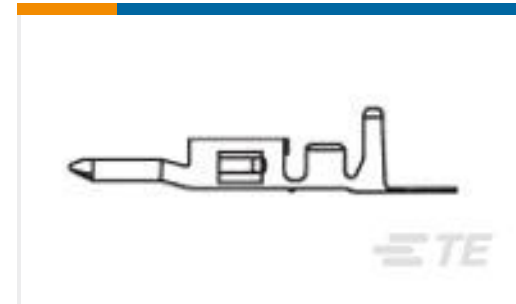
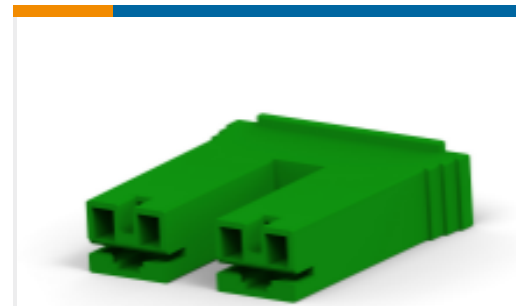
TE Part #2132781-6  
06P EP-II HOUSING, NATURALTE Part #3-520338-2  
ULTRA-FAST 187 ASY REC 16-14 AWG  
TPBRTE Part #63097-1  
250 PL MKII REC. 18-14AWG TPBRTE Part #2238016-1  
VAL-U-LOK PIN BR SN 18-22AWGTE Part #63482-1  
RING 18-14 AWG TPSTLTE Part #1-1971875-3  
PTL 3X3 CAP PANEL MT STD TEMP  
KEY A NATTE Part #1-520935-4  
PL 250 HOUSING REC GREENTE Part #1-520935-6  
HSG, RECP, POSI-LOCK&STD FAST250TE Part #1-520935-7  
PL 250 HOUSING REC 6/6 NYLON V0

## Documents

### Product Drawings

187 FASTON FLAG REC 20-16 AWG BR

English

### CAD Files

Customer View Model

ENG\_CVM\_CVM\_42486-1\_DJ.2d\_dxf.zip

English

3D PDF



3D

Customer View Model

[ENG\\_CVM\\_CVM\\_42486-1\\_DJ.3d\\_igs.zip](#)

English

Customer View Model

[ENG\\_CVM\\_CVM\\_42486-1\\_DJ.3d\\_stp.zip](#)

English

By downloading the CAD file I accept and agree to the [Terms and Conditions](#) of use.

---

### Datasheets & Catalog Pages

[82004 FASTON Terminals \(Insulated and Uninsulated\) Catalog - FASTON Receptacles Section](#)

English

---

### Product Specifications

[Product Specification](#)

English

---

### Product Environmental Compliance

[TE Material Declaration](#)

English

---

### Agency Approvals

[UL Report](#)

English