

PLEASE CHECK WWW.MOLEX.COM FOR LATEST PART INFORMATION

Part Number: [0355070900](#)
Status: **Active**
Overview: [Sherlock Wire-to-Board Connector System](#)
Description: 2.00mm Pitch Sherlock Wire-to-Board Housing, Natural, 9 Circuits

Documents:

3D Model	Product Specification PS-35507-003-001 (PDF)
Drawing (PDF)	Packaging Specification 355070200-100 (PDF)
3D Model (PDF)	Packaging Specification PK-35507-001 (PDF)
Product Specification PS-35507-001-001 (PDF)	RoHS Certificate of Compliance (PDF)
Product Specification PS-35507-002-001 (PDF)	

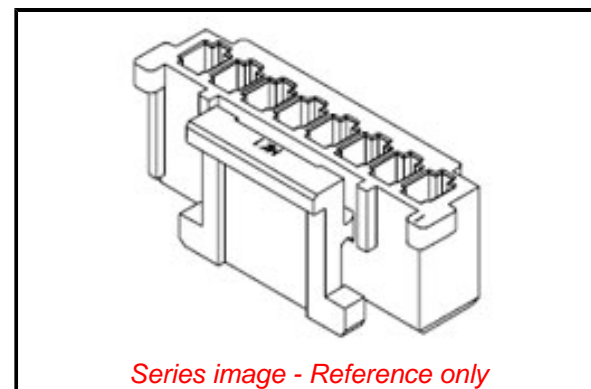

Agency Certification

CSA	LR19980
UL	E29179

General

Product Family	Crimp Housings
Series	35507
Application	Signal, Wire-to-Board
Overview	Sherlock Wire-to-Board Connector System
Product Name	Sherlock
UPC	800753877665

Physical

Circuits (maximum)	9
Circuits Detail	9
Color - Resin	Natural
Flammability	94V-0
Gender	Receptacle
Glow-Wire Capable	No
Keying to Mating Part	None
Lock to Mating Part	Yes
Material - Resin	Polyester
Net Weight	0.400/g
Number of Rows	1
Packaging Type	Bag
Panel Mount	No
Pitch - Mating Interface	2.00mm
Polarized to Mating Part	Yes
Stackable	No
Temperature Range - Operating	-40° to +105°C

Electrical

Current - Maximum per Contact	2.0A
-------------------------------	------

Material Info

Reference - Drawing Numbers

Packaging Specification	355070200-100, PK-35507-001
Product Specification	PS-35507-001-001, PS-35507-002-001, PS-35507-003-001
Sales Drawing	SD-35507-001, SD-35507-001-001, SD-35507-001-002

EU ELV

Not Relevant

EU RoHS

Compliant

REACH SVHC

Not Contained Per -
D(2020)4578-DC (25
June 2020)

Halogen-Free

Status

Not Low-Halogen

For more information, please visit [Contact US](#)

China ROHS

ELV

RoHS Phthalates

China RoHS

Green Image

Not Relevant

Not Contained

Search Parts in this Series

[35507 Series](#)

Mates With

Sherlock Wire-to-Board Header [35362](#) ,
[35363](#)

Use With

2.00mm Pitch Crimp Terminal [50212](#)