

SCALE 1:1

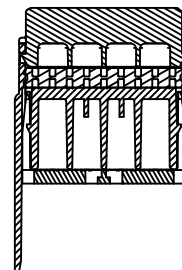

SECTION A-A

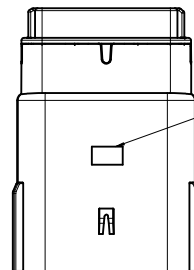
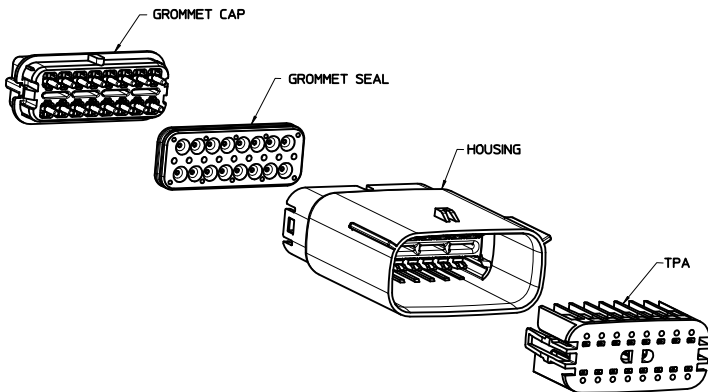
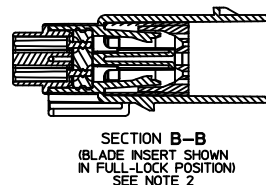
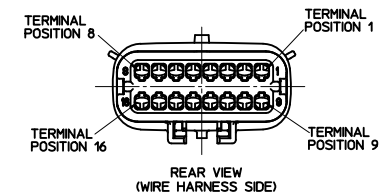

SECTION B-B
(BLADE INSERT SHOWN
IN FULL-LOCK POSITION)
SEE NOTE 2

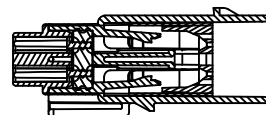

SECTION E-E
(BLADE INSERT SHOWN
IN PRE-LOCK POSITION)
SEE NOTE 2

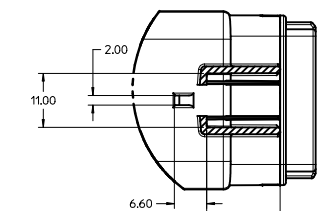
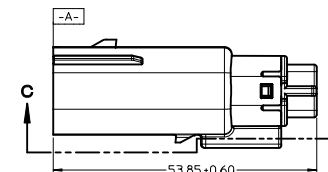
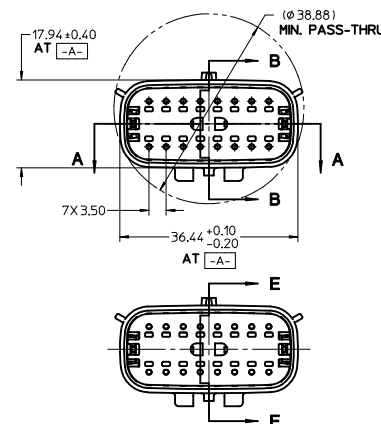

SECTION C-C

NOTES: UNLESS OTHERWISE STATED

- DESIGNED TO MATE WITH RECEPTACLE HOUSING ASSEMBLY SPECIFIED IN MOLEX CHARTED DRAWING SD-33472-161.
- ASSEMBLY SHIPPED WITH BLADE INSERT IN PRE-LOCKED POSITION (SEE SECTION E-E PRE-LOCK). UPON FULL TERMINAL ASSEMBLY EACH BLADE INSERT MUST BE SNAPPED INTO ITS FINAL-LOCK POSITION.
- FOR BLADE TERMINALS TO BE USED WITH THIS ASSEMBLY SEE DRAWING SD-33000-001.
- SYSTEM TO BE USED WITH WIRE WITHIN DIAMETER RANGE OF 1.5mm TO 2.5mm.
- MATERIAL: SPS/NYLON BLEND, 20% GLASS FILLED.
- SHALL CONFORM TO PACKAGING SPECIFICATION PK-31300-635.
- SHALL CONFORM TO PRODUCT SPECIFICATION PS-33472-000.
- ASSEMBLY CONFORMS TO SAE/USCAR-2 REV 4 WITH THE FOLLOWING EXCEPTIONS: TERMINAL INSERTION FORCE FOR WIRE SIZE ABOVE 2.5mm NOT EXCEEDING 2.69mm SHALL NOT EXCEED 45 NEWTONS.

ENTER DESCRIPTION IEC NO. UAU2010-1593 DRAWN BY 2010/03/30 CHKD BY 2010/03/30 APPR. VKOSHY 2010/04/06	QUALITY SYMBOLS ∇=0 ∇=0 ∇=0	GENERAL TOLERANCES (UNLESS SPECIFIED) mm INCH		DIMENSION STYLE MM ONLY	SCALE 2:1	DESIGN UNITS METRIC	THIRD ANGLE PROJECTION
		4 PLACES ± .10 3 PLACES ± .15 2 PLACES ± 0.10 1 PLACE ± 0.3	4 PLACES ± .004 3 PLACES ± .005 2 PLACES ± .003 1 PLACE ± .008	DRAWN BY DATE DGRIFITHS 05-29-03 CHECKED BY DATE DGRIFITHS 05-29-03 APPROVED BY DATE VKOSHY 2010/04/06	MATERIAL NO. SEE TABLE	DOCUMENT NO. SD-33482-161	TITLE MX150 BLADE CONNECTOR ASSEMBLY 2 ROW SEALED, 16 WAY
DRAFT WHERE APPLICABLE MUST REMAIN WITHIN DIMENSIONS		THIS DRAWING CONTAINS INFORMATION THAT IS PROPRIETARY TO MOLEX INCORPORATED AND SHOULD NOT BE USED WITHOUT WRITTEN PERMISSION					

ASSEMBLY PART NUMBER	COLOR	KEYING OPTION	DIMENSIONS (DEGREES)		CAVITY TYPE & STATUS (X = PLUGGED)															
			A	B	1	2	3	4	5	6	7	8	9	10	11	12	13	14	15	16
33482-1601	BLACK	A	60	60																
33482-1602	LT.GRAY	B	25	60																
33482-1603	BROWN	C	60	25																
33482-1604	GREEN	D	25	25																
33482-1605	CUSTOM	TBD																		
33482-1606	BLACK	A	60	60								X								
33482-1607	LT.GRAY	B	25	60								X								
33482-1608	BROWN	C	60	25								X								
33482-1609	GREEN	D	25	25								X								
33482-1610	CUSTOM	TBD										X								
33482-1611	BLACK	A	60	60								X	X							
33482-1612	LT.GRAY	B	25	60								X	X							
33482-1613	BROWN	C	60	25								X	X							
33482-1614	GREEN	D	25	25								X	X							
33482-1615	CUSTOM	TBD										X	X							
33482-1616	BLACK	A	60	60	X							X	X							
33482-1617	LT.GRAY	B	25	60	X							X	X							
33482-1618	BROWN	C	60	25	X							X	X							
33482-1619	GREEN	D	25	25	X							X	X							
33482-1620	CUSTOM	TBD			X							X	X							
33482-1621	BLACK	A	60	60	X	X	X	X	X	X	X	X	X	X	X	X	X	X	X	
33482-1622	LT.GRAY	B	25	60	X	X	X	X	X	X	X	X	X	X	X	X	X	X	X	
33482-1623	BROWN	C	60	25	X	X	X	X	X	X	X	X	X	X	X	X	X	X	X	
33482-1624	GREEN	D	25	25	X	X	X	X	X	X	X	X	X	X	X	X	X	X	X	
33482-1625	CUSTOM	TBD			X	X	X	X	X	X	X	X	X	X	X	X	X	X	X	
33482-1626	BLACK	A	60	60														X		
33482-1627	BLACK	A	60	60	X							X	X						X	
33482-1628	LT.GRAY	B	25	60	X							X	X						X	
33482-1629	BROWN	C	60	25	X							X	X						X	
33482-1630	GREEN	D	25	25	X							X	X						X	
33482-1631	CUSTOM	TBD			X							X	X						X	
33482-1632	BLACK	A	60	60				X				X	X		X	X	X			
33482-1633	BLACK	A	60	60			X	X	X			X	X	X	X	X	X	X	X	
33482-1634	BLACK	A	60	60							X	X			X	X				
33482-1635	LT.GRAY	B	25	60							X	X			X	X	X	X		
33482-1636	BLACK	A	60	60								X	X		X	X	X	X		
33482-1637	BLACK	A	60	60														X	X	
33482-1638	BLACK	A	60	60								X	X	X	X			X	X	
33482-1639	BLACK	A	60	60														X		
33482-1640	BLACK	A	60	60					X										X	
33482-1641	BLACK	A	60	60					X											
33482-1642	LT.GRAY	B	25	60			X		X	X	X			X		X				
33482-1643	BLACK	A	60	60														X	X	
33482-1644	LT.GRAY	B	25	60			X													
33482-1645	LT.GRAY	B	25	60			X		X	X	X									
33482-1646	BLACK	A	60	60			X		X	X	X				X					
33482-1647	BLACK	A	60	60															X	
33482-1648	BLACK	A	60	60			X							X						
33482-1649	LT.GRAY	B	25	60															X	
33482-1650	LT.GRAY	B	25	60				X						X		X				

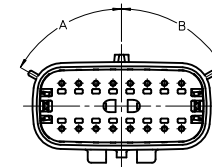

KEYING OPTION
SEE TABLE
SCALE 2:1

ENTER DESCRIPTION ELEC NO: UAU2010-1593 DRAWN BY: CHKO/SYERZYL APPR: VKOSHY 2010/03/30 2010/04/06	QUALITY SYMBOLS ∇=0 ∇=0 ∇=0	GENERAL TOLERANCES (UNLESS SPECIFIED) mm INCH		DIMENSION STYLE MM ONLY		SCALE 2:1	DESIGN UNITS METRIC	THIRD ANGLE PROJECTION	
		4 PLACES ± .0005	± .0005	DRAWN BY	DATE	TITLE MX150 BLADE CONNECTOR ASSEMBLY 2 ROW SEALED, 16 WAY			
		3 PLACES ± .001	± .001	CHECKED BY	DATE	MOLEX INCORPORATED			
		2 PLACES ± 0.10	± .001	APPROVED BY	DATE	MATERIAL NO. SD-33482-161 DOCUMENT NO. 2 OF 3			
DRAFT WHERE APPLICABLE MUST REMAIN WITHIN DIMENSIONS		ANGULAR ± 3°		SIZE D		THIS DRAWING CONTAINS INFORMATION THAT IS PROPRIETARY TO MOLEX INCORPORATED AND SHOULD NOT BE USED WITHOUT WRITTEN PERMISSION			

ASSEMBLY PART NUMBER	COLOR	KEYING OPTION	DIMENSIONS (DEGREES)		CAVITY TYPE & STATUS (X = PLUGGED)															
			A	B	1	2	3	4	5	6	7	8	9	10	11	12	13	14	15	16
33482-1651	LT.GRAY	B	25	60															X	
33482-1652	LT.GRAY	B	25	60						X	X	X							X	
33482-1653	BLACK	A	60	60								X							X	
33482-1654	BLACK	A	60	60				X				X			X					
33482-1655	LT.GRAY	B	25	60				X				X			X			X		
33482-1656	LT.GRAY	B	25	60								X						X		
33482-1657	BLACK	A	60	60	X							X								
33482-1658	LT.GRAY	B	25	60		X		X		X	X	X			X			X		
33482-1659	LT.GRAY	B	25	60		X				X	X	X						X		
33482-1660	LT.GRAY	B	25	60		X						X						X		
33482-1661	BLACK	A	60	60		X		X				X						X		
33482-1662	LT.GRAY	B	25	60		X		X				X						X		
33482-1663	BLACK	A	60	60		X						X								
33482-1664	BLACK	A	60	60			X					X	X						X	X
33482-1665	BLACK	A	60	60			X	X	X	X	X	X	X	X				X	X	
33482-1666	BLACK	A	60	60		X				X	X	X					X	X	X	
33482-1667	BLACK	A	60	60		X			X	X		X				X	X	X	X	
33482-1668	BLACK	A	60	60		X			X	X		X	X			X	X	X	X	
33482-1669	BLACK	A	60	60		X			X			X				X	X			
33482-1670	BLACK	A	60	60		X		X	X	X	X	X	X	X	X	X	X	X	X	
33482-1671	BLACK	A	60	60		X		X	X	X		X			X	X	X	X		
33482-1672	BLACK	A	60	60			X				X									
33482-1673	BLACK	A	60	60		X				X	X	X								
33482-1674	BLACK	A	60	60		X				X	X									
33482-1675	BLACK	A	60	60		X				X	X			X						
33482-1676	BLACK	A	60	60					X	X	X	X						X		
33482-1677	BLACK	A	60	60					X	X	X	X		X			X			
33482-1678	BLACK	A	60	60					X	X	X	X			X	X	X			
33482-1679	BLACK	A	60	60					X	X	X	X		X	X	X	X			
33482-1680	BLACK	A	60	60					X	X	X	X		X	X	X	X	X		
33482-1681	BLACK	A	60	60							X							X		
33482-1682	BLACK	A	60	60					X	X	X							X	X	
33482-1683	BLACK	A	60	60					X	X	X	X						X	X	
33482-1684	BLACK	A	60	60	X	X	X	X	X	X	X	X					X	X	X	X
33482-1685	BLACK	A	60	60							X						X	X	X	X
33482-1686	BLACK	A	60	60							X						X	X	X	X
33482-1687	BLACK	A	60	60							X	X		X	X	X	X	X		
33482-1688	BLACK	A	60	60							X	X		X	X	X	X	X		
33482-1689	BLACK	A	60	60							X	X		X						
33482-1690	BLACK	A	60	60							X	X					X			
33482-1691	BLACK	A	60	60					X							X				
33482-1692	BLACK	A	60	60		X						X	X						X	X
33482-1693	BLACK	A	60	60		X						X							X	
33482-1694	BLACK	A	60	60		X			X	X	X	X	X	X	X	X	X	X	X	
33482-1695	BLACK	A	60	60		X			X	X	X	X		X		X	X	X		
33482-1700	BLACK	A	60	60	X	X	X	X	X	X	X	X		X	X	X	X	X	X	X
33482-1701	BLACK	A	60	60	X	X	X	X	X	X	X	X		X	X	X	X	X	X	X
33482-1702	BLACK	A	60	60						X	X	X	X	X	X	X	X	X	X	X
33482-1703	BLACK	A	60	60						X	X	X	X	X	X	X	X	X	X	X
33482-1704	BLACK	A	60	60	X	X	X	X	X	X								X	X	X
33482-1705	BLACK	A	60	60							X	X	X	X	X	X	X	X	X	X
33482-1706	BLACK	A	60	60							X	X	X	X	X	X	X	X	X	X
33482-1707	BLACK	A	60	60						X	X	X	X							
33482-1708	BLACK	A	60	60														X	X	X
33482-1709	BLACK	A	60	60														X	X	X
33482-1710	BLACK	A	60	60	X	X	X	X	X	X	X	X	X	X	X	X	X	X	X	X

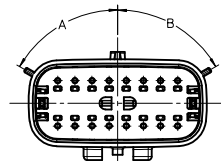

ENTER DESCRIPTION IEC NO: UAU2010-1593 DRAWN BY: 2010/03/30 CHKD: SVRZYL APPR: VKOSHY 2010/04/06 REV: AA	QUALITY SYMBOLS ∇=0 ∇=0 ∇=0	GENERAL TOLERANCES (UNLESS SPECIFIED) mm INCH 4 PLACES ± --- ± --- 3 PLACES ± --- ± --- 2 PLACES ± 0.10 ± --- 1 PLACE ± 0.3 ± --- ANGULAR ± 3 °	DIMENSION STYLE MM ONLY SCALE 2:1 DESIGN UNITS METRIC THIRD ANGLE PROJECTION	DRAWN BY: DGR1FF DATE: 05-29-03 CHECKED BY: DGR1FF DATE: 05-29-03 APPROVED BY: VKOSHY DATE: 2010/04/06	TITLE: MX150 BLADE CONNECTOR ASSEMBLY 2 ROW SEALED, 16 WAY MATERIAL NO: SEE TABLE DOCUMENT NO: SD-33482-161	SHEET NO: 3 OF 3
	THIS DRAWING CONTAINS INFORMATION THAT IS PROPRIETARY TO MOLEX INCORPORATED AND SHOULD NOT BE USED WITHOUT WRITTEN PERMISSION					
	DRAFT WHERE APPLICABLE MUST REMAIN WITHIN DIMENSIONS					
	SIZE D					