

316371-1 ✓ ACTIVE

AMP | Multilock Connector System

TE Internal #: 316371-1

Housing for Female Terminals, Wire-to-Device / Wire-to-Board, 24
Position, .098 in [2.5 mm] Centerline, White, Signal, Multilock
Connector System

[View on TE.com >](#)



Connectors > Automotive Connectors > Connector Housings > MULTILOCK, CONNECTOR HOUSING

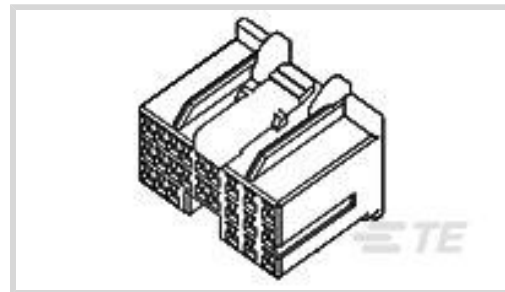

Connector & Housing Type: **Housing for Female Terminals**

Mating Tab Width: **1 mm [.039 in]**

Connector System: **Wire-to-Board, Wire-to-Device**

Number of Positions: **24**

Centerline (Pitch): **2.5 mm [.098 in]**

[All MULTILOCK, CONNECTOR HOUSING \(576\)](#)

Features

Product Type Features

Connector & Housing Shape	Rectangular
Connector & Housing Type	Housing for Female Terminals
Connector System	Wire-to-Board, Wire-to-Device
Sealable	No
Hybrid Connector	No
Primary Locking Feature	Integrated in Housing

Configuration Features

Number of Positions	24
Number of Rows	3

Electrical Characteristics

Operating Voltage	12 VDC
Nominal Voltage Architecture	12 V

Body Features

Cable Exit Angle	180°
Body Material	PBT
Primary Product Color	White



Contact Features

Contact Size	1mm
Contact Type	Receptacle
Mating Tab Width	1 mm[.039 in]

Mechanical Attachment

Mounting Feature	Without
Terminal Position Assurance	Yes
Strain Relief	Without
Mating Alignment Type	Polarized
Mating Alignment	With
Connector Mounting Type	Cable Mount (Free-Hanging)

Housing Features

Centerline (Pitch)	2.5 mm[.098 in]
--------------------	-----------------

Dimensions

Product Width	27.5 mm[1.083 in]
Product Length	21 mm[.827 in]
Product Height	21.7 mm[.854 in]
Row-to-Row Spacing	4.6 mm[.181 in]

Usage Conditions

Operating Temperature (Max)	70 °C, 75 °C, 80 °C, 85 °C, 90 °C, 100 °C, 105 °C, 110 °C, 120 °C[158 °F][167 °F][176 °F][185 °F][194 °F][212 °F][221 °F][230 °F][248 °F]
Operating Temperature Range	-40 – 120 °C[-40 – 248 °F]

Operation/Application

Circuit Application	Signal
---------------------	--------

Industry Standards

UL Flammability Rating	UL 94HB
------------------------	---------

Packaging Features

Packaging Quantity	100
--------------------	-----

Other

Serviceable	Yes
Connector Position Assurance Capable	No

Product Compliance



[For compliance documentation, visit the product page on TE.com>](#)

EU RoHS Directive 2011/65/EU	Compliant
EU ELV Directive 2000/53/EC	Compliant
China RoHS 2 Directive MIIT Order No 32, 2016	No Restricted Materials Above Threshold
EU REACH Regulation (EC) No. 1907/2006	Current ECHA Candidate List: JUNE 2022 (224) Candidate List Declared Against: JAN 2022 (223) SVHC > Threshold: Not Yet Reviewed
Halogen Content	Low Halogen - Br, Cl, F, I < 900 ppm per homogenous material. Also BFR/CFR/PVC Free
Solder Process Capability	Not applicable for solder process capability

Product Compliance Disclaimer

This information is provided based on reasonable inquiry of our suppliers and represents our current actual knowledge based on the information they provided. This information is subject to change. The part numbers that TE has identified as EU RoHS compliant have a maximum concentration of 0.1% by weight in homogenous materials for lead, hexavalent chromium, mercury, PBB, PBDE, DBP, BBP, DEHP, DIBP, and 0.01% for cadmium, or qualify for an exemption to these limits as defined in the Annexes of Directive 2011/65/EU (RoHS2). Finished electrical and electronic equipment products will be CE marked as required by Directive 2011/65/EU. Components may not be CE marked. Additionally, the part numbers that TE has identified as EU ELV compliant have a maximum concentration of 0.1% by weight in homogenous materials for lead, hexavalent chromium, and mercury, and 0.01% for cadmium, or qualify for an exemption to these limits as defined in the Annexes of Directive 2000/53/EC (ELV). Regarding the REACH Regulation, the information TE provides on SVHC in articles for this part number is based on the latest European Chemicals Agency (ECHA) 'Guidance on requirements for substances in articles' posted at this URL: <https://echa.europa.eu/guidance-documents/guidance-on-reach>

Compatible Parts

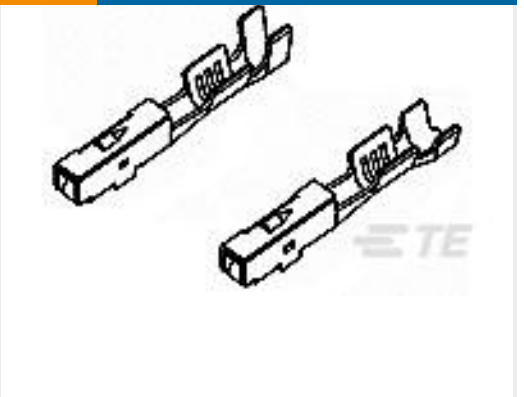
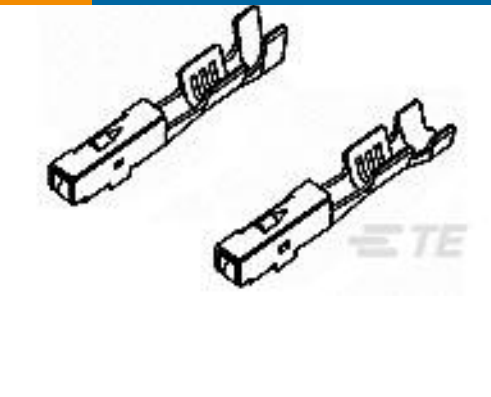
 <p>TE Part # CAT-HPCH5372 HIGH PIN COUNT HEADER</p>	 <p>TE Part # CAT-M9194-T273 MULTILOCK, RECEPTACLE AND TAB</p>	 <p>TE Part # 179418-2 PMC 040 REC S L/P</p>	 <p>TE Part # 175266-7 040 REC CONT. SHORT FORM</p>
---	--	---	--

Also in the Series | [Multilock Connector System](#)



Automotive Connector Caps & Covers (16)



Automotive Connector EMC Shielding (1)

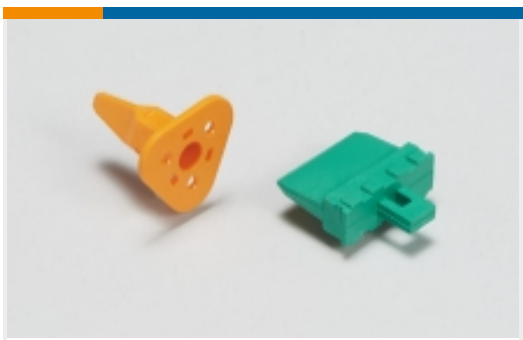

Automotive Connector Locks & Position Assurance(2)



Automotive Housings(575)



Automotive Seals & Cavity Plugs(2)



Automotive Terminals(140)



Insertion & Extraction Tools(6)



Other Automotive Connector Accessories(9)

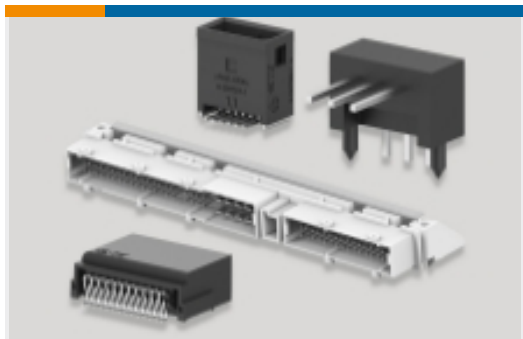

PCB Headers & Receptacles(129)

Customers Also Bought



TE Part #174047-2
MULTILOCK, CONNECTOR HOUSING



TE Part #1318774-1
TH/.025 CONNECTOR SYSTEM, HOUSING

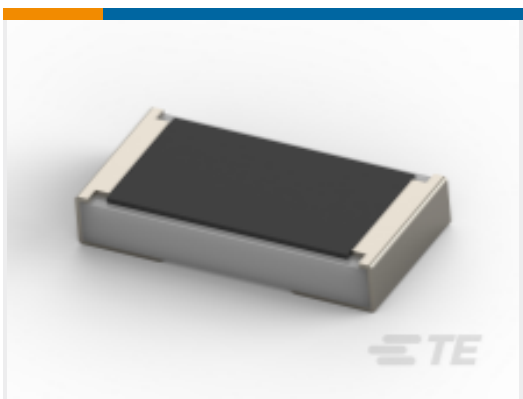

TE Part #2176231-1
SMD Power Resistor: 3 Watt, 1% Tol



TE Part #7-1393117-7
KUP-14A15-12=KU



TE Part #1718091-1
AMP MCP 2.8 JPT HSG 17 POS ASS

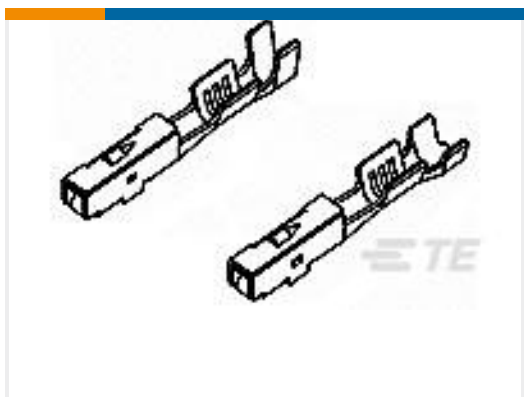

TE Part #175265-1
040 REC (S) FOR NSCC

Documents



Product Drawings

040 II SRS MK-II 24P PLUG ASSY

English

CAD Files

Customer View Model

[ENG_CVM_316371-1_A.3d_igs.zip](#)

English

Customer View Model

[ENG_CVM_316371-1_A.3d_stp.zip](#)

English

Customer View Model

[ENG_CVM_316371-1_A.2d_dxf.zip](#)

English

3D PDF

English

By downloading the CAD file I accept and agree to the [Terms and Conditions](#) of use.

Datasheets & Catalog Pages

MULTILOCK Connector System

English

Product Specifications

040II/070II Multi Lock Connector MK-II Type

Japanese

Product Specification

Japanese

Product Environmental Compliance

Product Compliance

English

Product Compliance

English

Instruction Sheets

Instruction Sheet (non U.S.)

English

[.040II SERIES MULTI-LOCK CONNECTOR MK-II 72POS.](#)

English