



MTA 100

TE Internal #: 3-640443-6

Standard Rectangular Connectors, Connector Assembly, Receptacle, Mating Retention, Insulation Displacement (IDC), Wire-to-Board, Tin, Normal, MTA 100

[View on TE.com >](#)

Connectors > Rectangular Connectors > Standard Rectangular Connectors > Nylon Tin Plated Receptacle: 2.54mm, No Mating Alignment, MTA 100

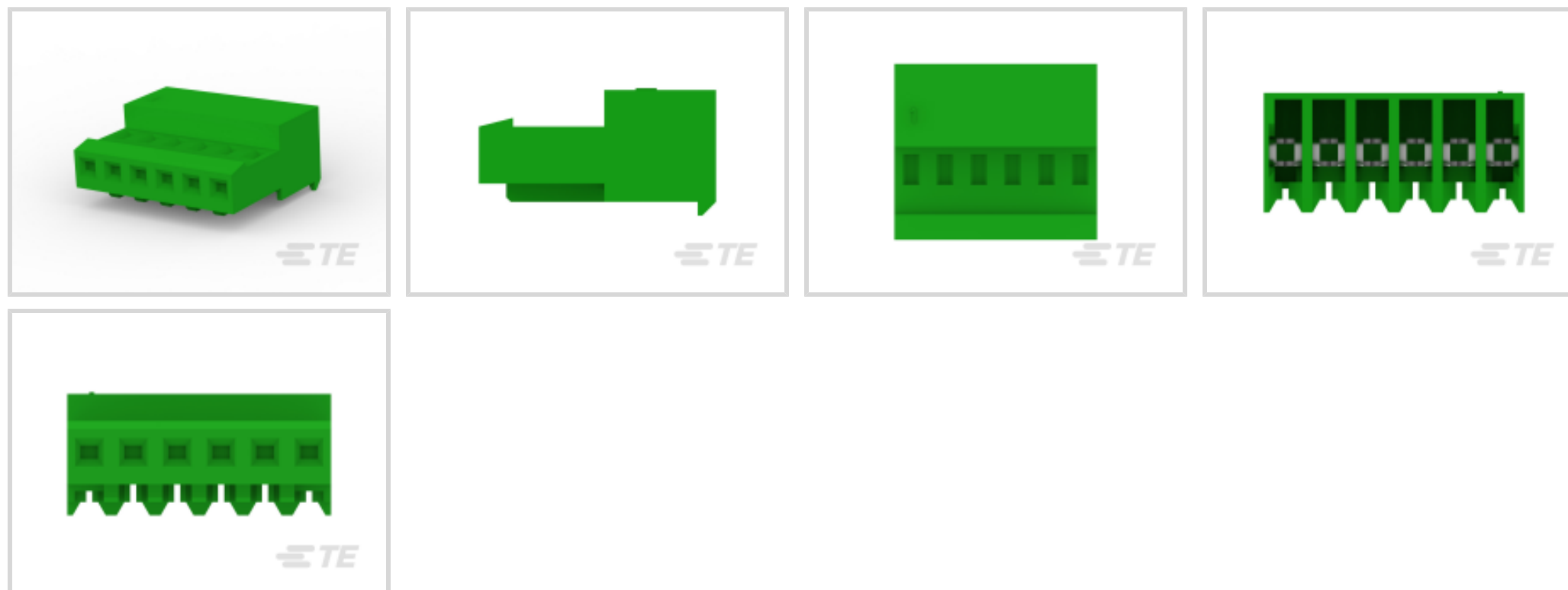

Connector Product Type: **Connector Assembly**

Connector & Housing Type: **Receptacle**

Mating Alignment: **Without**

Mating Retention: **With**

Mating Retention Type: **Locking Ramp**

[All Nylon Tin Plated Receptacle: 2.54mm, No Mating Alignment, MTA 100 \(481\)](#)

## Features

### Product Type Features

Product Style	Assembly
Shape	Rectangular
Wire/Cable Type	Stranded
Connector Type	Connector Assembly
Housing Type	Receptacle
Connector Product Type	Connector Assembly
Connector & Housing Type	Receptacle
Connector System	Wire-to-Board
Insertion Force Type	Normal
Sealable	No
Connector & Contact Terminates To	Wire & Cable

### Configuration Features

Number of Cavities	6
--------------------	---



Number of Positions	6
Number of Rows	1
Panel Gasket	Without

#### Electrical Characteristics

Operating Voltage	250 VAC
-------------------	---------

#### Contact Features

Contact Layout	In-line
Contact Type	Female
Wire Contact Termination Area Plating Material	Tin
Contact Underplating Material	Nickel
Contact Mating Area Plating Material	Tin
Contact Retention Within Housing	With
Contact Current Rating (Max)	5 A

#### Termination Features

Termination Method to Wire & Cable	Insulation Displacement (IDC)
------------------------------------	-------------------------------

#### Mechanical Attachment

Panel Mount	No
Contact Retention Type Within Housing	Locking Lance
Panel Mount Feature	Without
Mating Alignment	Without
Mating Retention	With
Mating Retention Type	Locking Ramp
Connector Mounting Type	Cable Mount (Free-Hanging)

#### Housing Features

Housing Color	Green
Housing Material	Nylon 6/6
Centerline (Pitch)	2.54 mm[.1 in]

#### Dimensions

Width	6.99 mm[.275 in]
Height	13.21 mm[.52 in]
Length	15.24 mm[.6 in]
Wire Size	.08 – .09 mm <sup>2</sup>



### Usage Conditions

Operating Temperature Range	-55 – 105 °C[-67 – 221 °F]
-----------------------------	----------------------------

### Operation/Application

Shielded	No
Circuit Application	Signal

### Industry Standards

CSA Rating	Certified
Agency/Standard	CSA, UL
UL Rating	Recognized
CSA File Number	LR7189
UL File Number	E28476
UL Flammability Rating	UL 94V-2

### Packaging Features

Packaging Quantity	250
Packaging Method	Box & Carton

### Product Compliance

[For compliance documentation, visit the product page on TE.com>](#)

EU RoHS Directive 2011/65/EU	Compliant
EU ELV Directive 2000/53/EC	Compliant
China RoHS 2 Directive MIIT Order No 32, 2016	No Restricted Materials Above Threshold
EU REACH Regulation (EC) No. 1907/2006	Current ECHA Candidate List: JUNE 2022 (224) Candidate List Declared Against: JAN 2022 (223) SVHC > Threshold: Not Yet Reviewed
Halogen Content	Low Halogen - Br, Cl, F, I < 900 ppm per homogenous material. Also BFR/CFR/PVC Free
Solder Process Capability	Not applicable for solder process capability

#### Product Compliance Disclaimer

This information is provided based on reasonable inquiry of our suppliers and represents our current actual knowledge based on the information they provided. This information is subject to change. The part numbers that TE has identified as EU RoHS compliant have a maximum concentration of 0.1% by weight in homogenous materials for lead, hexavalent chromium, mercury, PBB, PBDE, DBP, BBP, DEHP, DIBP, and 0.01% for cadmium, or qualify for an exemption to these

limits as defined in the Annexes of Directive 2011/65/EU (RoHS2). Finished electrical and electronic equipment products will be CE marked as required by Directive 2011/65/EU. Components may not be CE marked. Additionally, the part numbers that TE has identified as EU ELV compliant have a maximum concentration of 0.1% by weight in homogenous materials for lead, hexavalent chromium, and mercury, and 0.01% for cadmium, or qualify for an exemption to these limits as defined in the Annexes of Directive 2000/53/EC (ELV). Regarding the REACH Regulation, the information TE provides on SVHC in articles for this part number is based on the latest European Chemicals Agency (ECHA) 'Guidance on requirements for substances in articles' posted at this URL: <https://echa.europa.eu/guidance-documents/guidance-on-reach>

## Compatible Parts



TE Part # CAT-104MTA-PRUMH  
Polyester Right Angle PCB Header: 2.54mm, Wire-to-Board, MTA 100

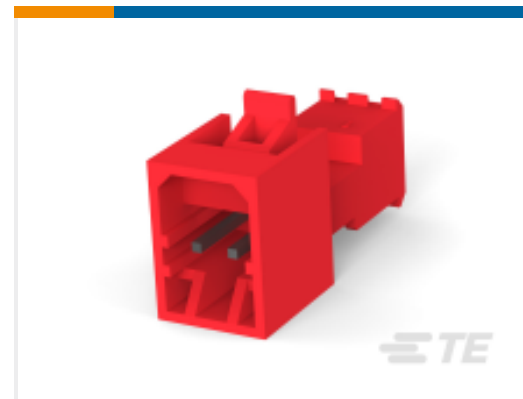

TE Part # CAT-104MTA-NTPMP  
Nylon Tin Plated Plug: 2.54mm, With Mating Alignment, MTA 100

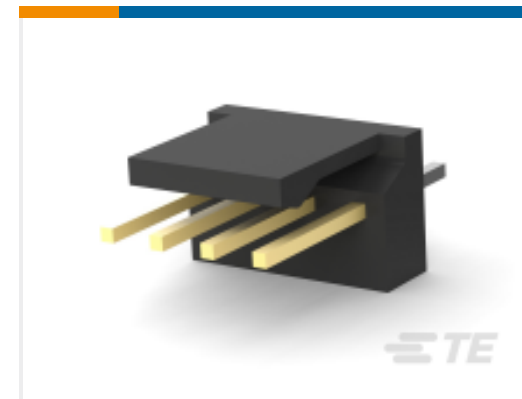

TE Part # CAT-104MTA-NVTHH  
Nylon Vertical PCB Header: 2.54mm, Through Hole, MTA 100

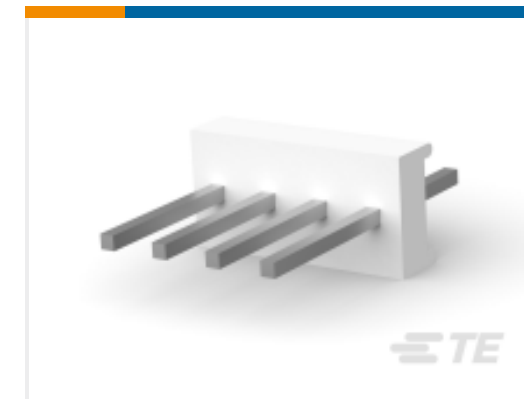

TE Part # CAT-104MTA-PVUNH  
Polyester Vertical PCB Header: 2.54 mm, Unshrouded, No Mating Alignment



TE Part # CAT-104MTA-PRUSH  
Polyester Right Angle PCB Header: 2.54mm, Unshrouded, MTA 100



TE Part # CAT-104MTA-PLSCC  
Polyester PCB Connector Covers: 2.54 mm, MTA 100

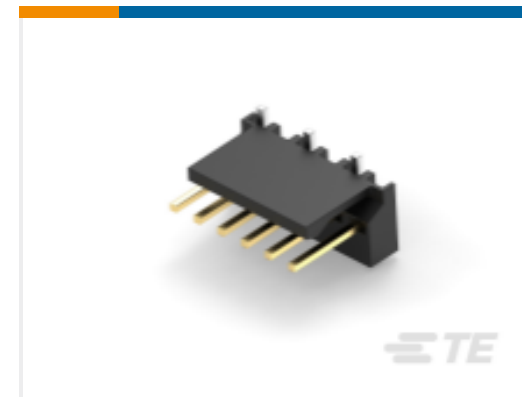

TE Part # CAT-104MTA-NVSMH  
Nylon Vertical PCB Header: 2.54mm, Surface Mount, MTA 100



TE Part # 640454-6  
06P MTA100 HDR ASSY SQ STR POL

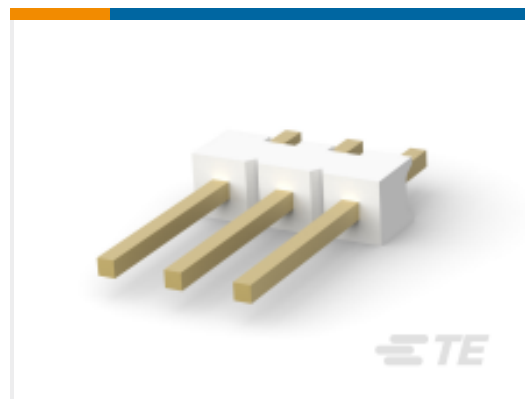

TE Part # CAT-104MTA-PVBRH  
Polyester Vertical PCB Header: 2.54 mm, Breakaway, MTA 100



TE Part # CAT-104MTA-PRSMH  
Polyester Right Angle PCB Header: 2.54mm, Shrouded, With Mating Alignment



TE Part # CAT-104MTA-NYLCC  
Nylon PCB Connector Covers: 2.54 mm, MTA 100



TE Part # CAT-104MTA-PVSHH  
Polyester Vertical PCB Header: 2.54 mm, Shrouded, MTA 100



TE Part # 58074-1  
MTA 50/100/156 MANUAL TOOL FRAME



TE Part # 3-644694-6  
06P MTA100 R/A HDR RETENTIVE

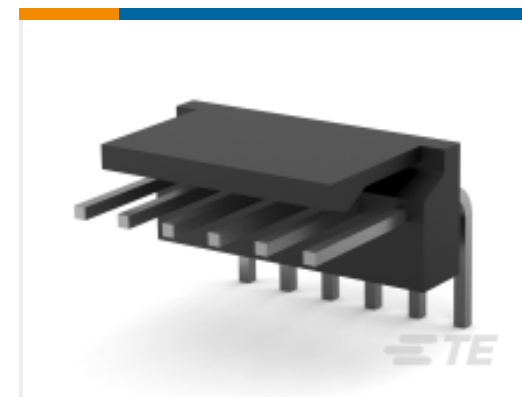

TE Part # 3-647051-6  
06P MTA100 HRD ASSYF/L HT LF



TE Part # 58246-1  
MTA 100 CRIMP HEAD REPAIR DISCRETE



Also in the Series | **MTA 100**

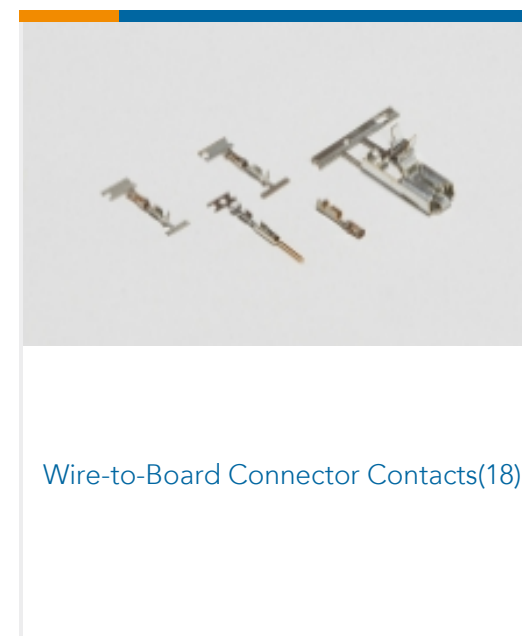
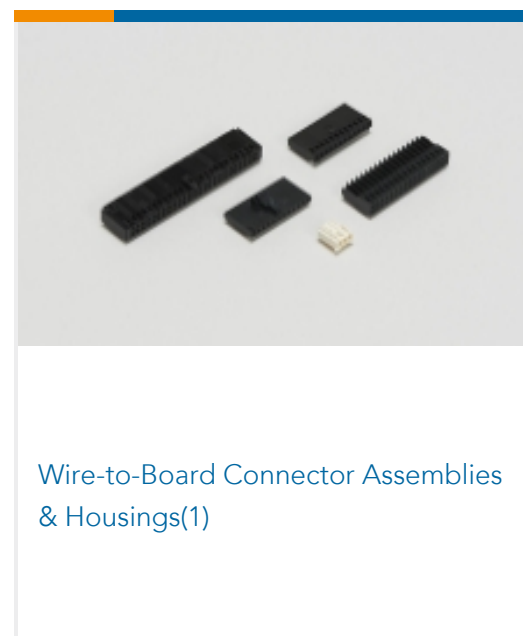
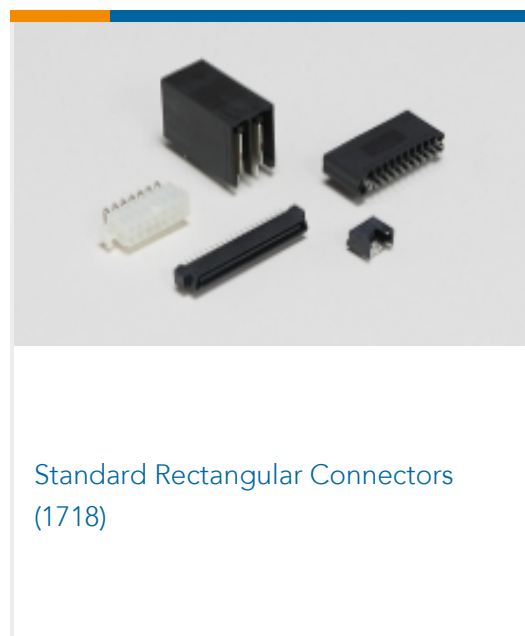
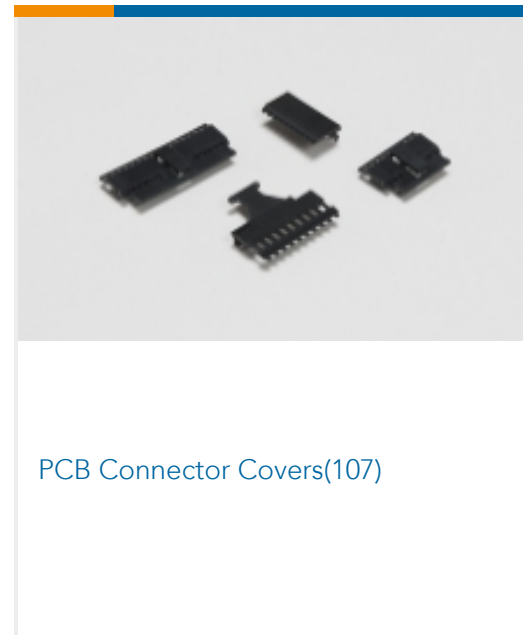
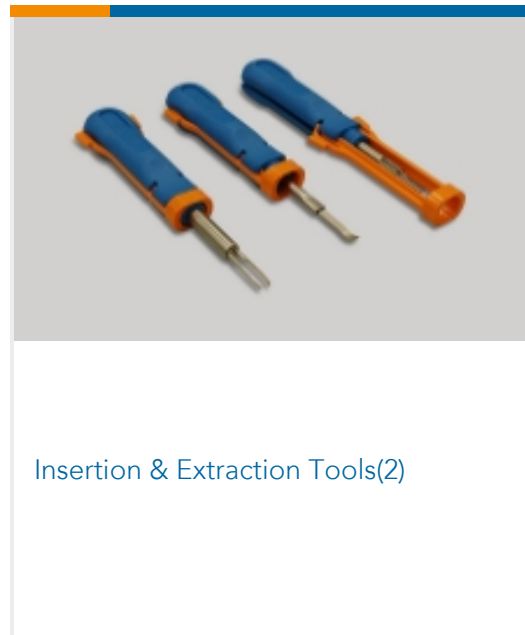

Customers Also Bought

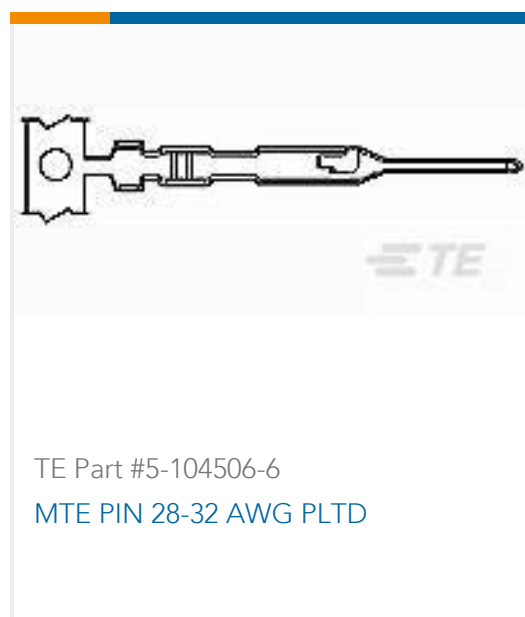
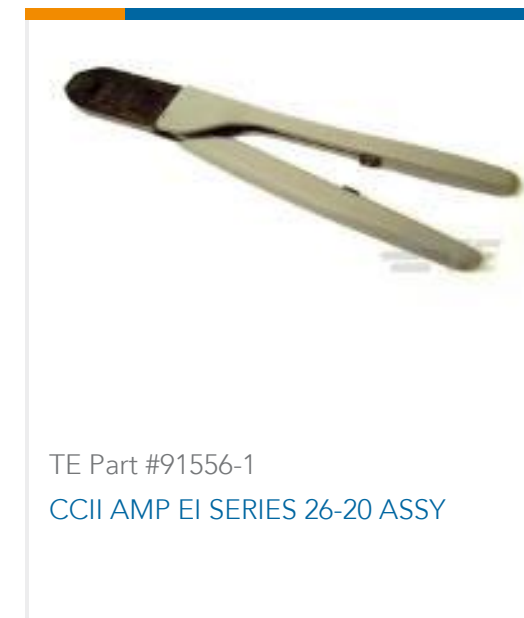



## Documents

### Product Drawings

[06P MTA100 CONN ASSY GRN](#)

English

---

### CAD Files

Customer View Model

[ENG\\_CVM\\_CVM\\_3-640443-6\\_U.2d\\_dxf.zip](#)

English

[3D PDF](#)

3D

Customer View Model

[ENG\\_CVM\\_CVM\\_3-640443-6\\_U.3d\\_igs.zip](#)

English

Customer View Model

[ENG\\_CVM\\_CVM\\_3-640443-6\\_U.3d\\_stp.zip](#)

English

By downloading the CAD file I accept and agree to the [Terms and Conditions](#) of use.

---

### Datasheets & Catalog Pages

[MTA, CST-100 II, SL-156 and AMP Economy Power \(EP\) Connectors](#)

English

---

### Product Specifications

[Application Specification](#)

English

---

### Product Environmental Compliance

[MD\\_3-640443-6\\_01202016220\\_dmtec](#)

English

[MD\\_3-640443-6\\_01202016220\\_dmtec](#)

English

---

### Agency Approvals

[UL Report](#)

English