

316092-1 ✓ ACTIVE

AMP Signal Double Lock

TE Internal #: 316092-1

Housing, Plug, Wire-to-Wire, 8 Position, 2.5 mm [.098 in] Centerline, Crimp, 1 Row, Natural, Wire & Cable, Power & Signal, AMP Signal Double Lock

[View on TE.com >](#)



[Connectors >](#) [PCB Connectors >](#) [Wire-to-Board Connectors >](#) [Wire-to-Board Connector Assemblies & Housings >](#)

STD Temp Signal Double Lock Cap



Connector Product Type: **Housing**

Connector & Housing Type: **Plug**

Connector System: **Wire-to-Wire**

Number of Positions: **8**

Centerline (Pitch): **2.5 mm [.098 in]**

[All STD Temp Signal Double Lock Cap \(21\)](#)

Features

Product Type Features

Connector Product Type	Housing
Connector & Housing Type	Plug
Connector System	Wire-to-Wire
Sealable	No
Connector & Contact Terminates To	Wire & Cable

Configuration Features

Number of Positions	8
Number of Rows	1

Electrical Characteristics

Operating Voltage	250 VAC
-------------------	---------

Contact Features

--	--



Contact Layout	Inline
Contact Type	Tab
Contact Base Material	Phosphor Bronze
Contact Current Rating (Max)	3 A

Termination Features

Termination Method to Wire & Cable	Crimp
------------------------------------	-------

Mechanical Attachment

Strain Relief	Without
Panel Mount Feature	Without
PCB Mount Retention	Without
Mating Retention	Without
Connector Mounting Type	Cable Mount (Free-Hanging)

Housing Features

Housing Material	Nylon 66
Centerline (Pitch)	2.5 mm [.098 in]
Housing Color	Natural

Dimensions

Connector Length	18.1 mm [.713 in]
Connector Height	9.6 mm [.378 in]
Wire Size	26 – 20 AWG

Usage Conditions

Operating Temperature Range	-30 – 105 °C [-22 – 221 °F]
-----------------------------	-----------------------------

Operation/Application

Circuit Application	Power & Signal
---------------------	----------------

Industry Standards

Glow Wire Rating	Standard Part - Not Glow Wire
UL Flammability Rating	UL 94V-0

Packaging Features

Packaging Quantity	150
Packaging Method	Bag

Product Compliance



[For compliance documentation, visit the product page on TE.com>](#)

EU RoHS Directive 2011/65/EU	Compliant
EU ELV Directive 2000/53/EC	Compliant
China RoHS 2 Directive MIIT Order No 32, 2016	No Restricted Materials Above Threshold
EU REACH Regulation (EC) No. 1907/2006	Current ECHA Candidate List: JUNE 2022 (224) Candidate List Declared Against: JUNE 2022 (224) Does not contain REACH SVHC
Halogen Content	Low Halogen - Br, Cl, F, I < 900 ppm per homogenous material. Also BFR/CFR/PVC Free
Solder Process Capability	Not applicable for solder process capability

Product Compliance Disclaimer

This information is provided based on reasonable inquiry of our suppliers and represents our current actual knowledge based on the information they provided. This information is subject to change. The part numbers that TE has identified as EU RoHS compliant have a maximum concentration of 0.1% by weight in homogenous materials for lead, hexavalent chromium, mercury, PBB, PBDE, DBP, BBP, DEHP, DIBP, and 0.01% for cadmium, or qualify for an exemption to these limits as defined in the Annexes of Directive 2011/65/EU (RoHS2). Finished electrical and electronic equipment products will be CE marked as required by Directive 2011/65/EU. Components may not be CE marked. Additionally, the part numbers that TE has identified as EU ELV compliant have a maximum concentration of 0.1% by weight in homogenous materials for lead, hexavalent chromium, and mercury, and 0.01% for cadmium, or qualify for an exemption to these limits as defined in the Annexes of Directive 2000/53/EC (ELV). Regarding the REACH Regulation, the information TE provides on SVHC in articles for this part number is based on the latest European Chemicals Agency (ECHA) 'Guidance on requirements for substances in articles' posted at this URL: <https://echa.europa.eu/guidance-documents/guidance-on-reach>

Compatible Parts



TE Part # 917692-1
2.5 SIGNAL D/LOCK PLUG HSG 8P



TE Part # CAT-SI261-T111
Signal Double Lock Tab



TE Part # 316398-1
2.5 SIGNAL D/L TAB CONT. L L/P



TE Part # 316399-1
2.5 SIGNAL D/L TAB CONT. M L/P

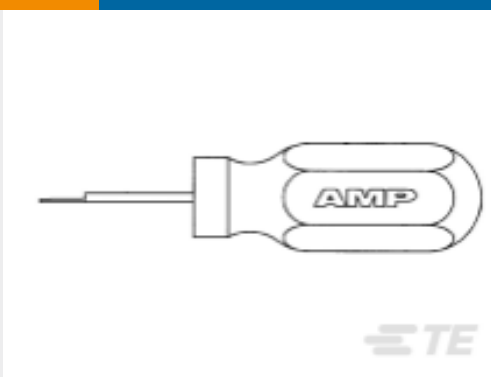

TE Part # 234605-1
EXT-TOOL

Also in the Series | AMP Signal Double Lock



Connector Contacts(8)



Insertion & Extraction Tools(1)

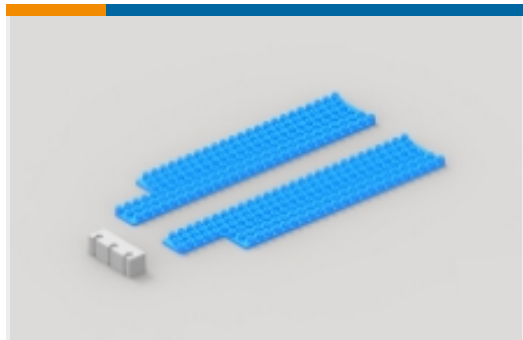

PCB Connector Seals(1)

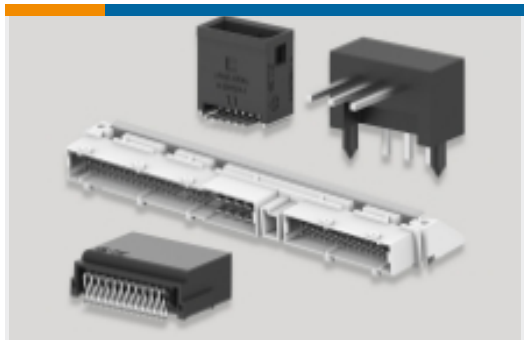

PCB Headers & Receptacles(145)

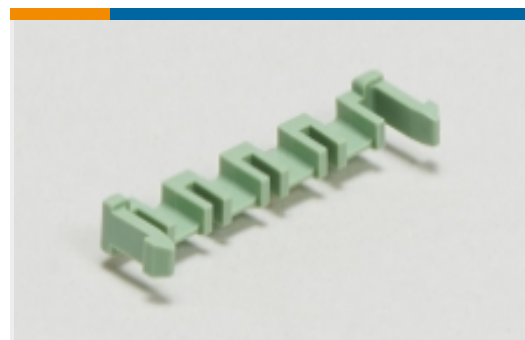

PCB Latches, Locks & Retainers(17)



Rectangular Caps & Covers(1)



Rectangular Connector Housings(23)



Rectangular Connector Locking(2)

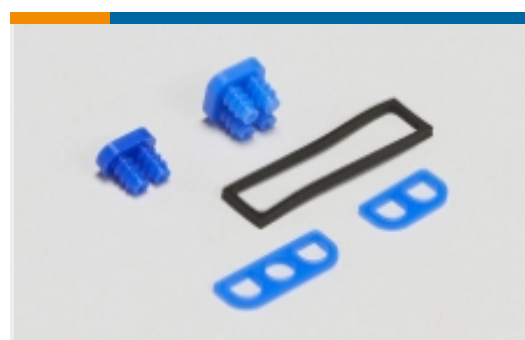

Rectangular Connector Seals(10)



Rectangular Power Connectors(3)

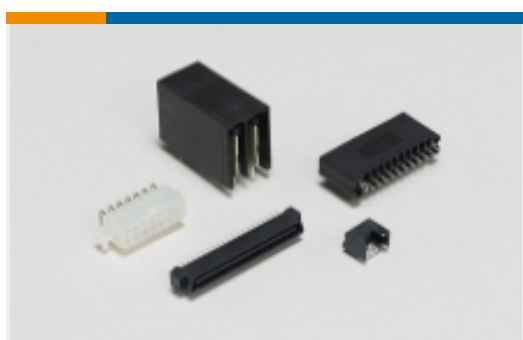

Standard Rectangular Connectors(1)



Wire-to-Board Connector Assemblies & Housings(74)



Wire-to-Board Connector Contacts(6)

Customers Also Bought



TE Part #316090-1
STD Temp Signal Double Lock Cap



TE Part #917702-1
Signal Double Lock TPA



TE Part #917689-1
STD Temp Signal Double Lock Plug

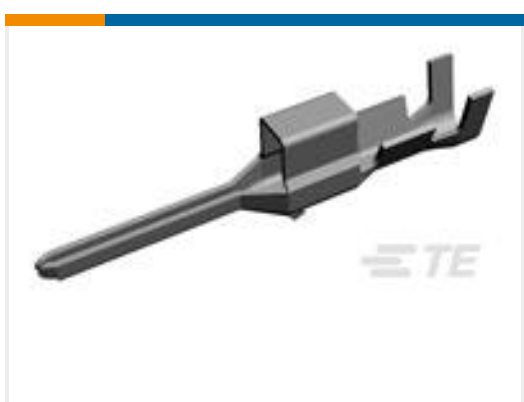

TE Part #917765-1
2.5 SIGNAL D/LOCK TAB CONT. M



Documents

Product Drawings

[2.5 SIGNAL D/LOCK CAP HSG 8P](#)

English

CAD Files

[3D PDF](#)

3D

Customer View Model

[ENG_CVM_CVM_316092-1_H.2d_dxf.zip](#)

English

Customer View Model

[ENG_CVM_CVM_316092-1_H.3d_igs.zip](#)

English

Customer View Model

[ENG_CVM_CVM_316092-1_H.3d_stp.zip](#)

English

By downloading the CAD file I accept and agree to the [Terms and Conditions](#) of use.

Datasheets & Catalog Pages

[SOFT_SHELL_PIN_AND_SOCKET_CONNECTORS_CATALOG](#)

English

[1773458-3_2.5MM_SIGNAL_DOUBLE_LOCK_CONNECTORS](#)

English

Product Environmental Compliance

[TE Material Declaration](#)

English

Instruction Sheets

[Instruction Sheet \(non U.S.\)](#)

English

[AMP 2.5 SIGNAL DOUBLE LOCK CONNECTOR SERIES](#)

English

Agency Approvals

[CSA Certificate](#)

316092-1

Housing, Plug, Wire-to-Wire, 8 Position, 2.5 mm [.098 in] Centerline, Crimp, 1 Row,
Natural, Wire & Cable, Power & Signal, AMP Signal Double Lock



English

[CSA Certificate](#)

English