

PRODUCT ID LABEL
(1) PER REEL

SEE DETAIL 1

SHIPPER ID LABEL
(1-2)/CARTON AS REQUIRED

PALLET 0313016630
635 mm X 635 mm
(26" X 26")
(SEE NOTE 6)

CUSTOMER COPY

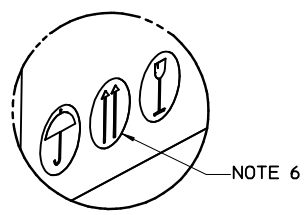

DETAIL 1
SCALE 1:1.33

**PAYOFF
DIRECTION D**

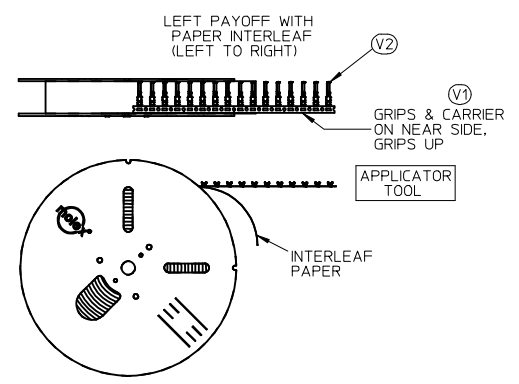

PLACE PRODUCT ID LABEL ON THIS SIDE TO INDICATE THE PREFERRED PACKAGING ORIENTATION

**PAYOFF
DIRECTION B**

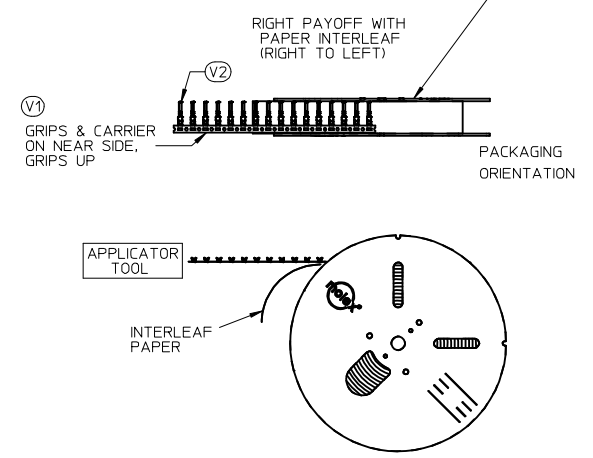

- NOTES:
1. NUMBER OF TERMINALS PER REEL: SEE TABLE (SHEET 2)
 2. STANDARD PACK QUANTITY (SPQ): SEE TABLE (SHEET 2)
 3. NUMBER OF REELS PER CARTON: SEE TABLE (SHEET 2)
 4. SPLICING: NO BREAKS, MAXIMUM 1 WELD PER REEL
 5. TO MINIMIZE STRESS ON TERMINALS, REELS SHOULD ALWAYS BE SHIPPED ON PALLETS WITH THE REELS LAYING FLAT AS SHOWN.
 6. PLACE CARTONS ON PALLET WITH ARROWS POINTING UP PER DETAIL 1
 7. FOR INTERNAL COPY SEE: PK-31301-053

SPO CORRECTION EC NO: UAU2015-0955 DRAWN: PHELPS 2014/12/19 CHKD: JNORTHRO APPR: JNORTHRO 2015/01/26 REV: 4	QUALITY SYMBOLS ▽=0 ▽=0	GENERAL TOLERANCES (UNLESS SPECIFIED) mm INCH 4 PLACES ± --- ± --- 3 PLACES ± --- ± --- 2 PLACES ± --- ± --- 1 PLACE ± --- ± --- ANGULAR ± 1 °	DIMENSION STYLE MM ONLY DRAWN BY DATE PPHELPS 2012/10/24 CHECKED BY DATE	SCALE 1:10 DESIGN UNITS METRIC THIRD ANGLE PROJECTION	TITLE CTX PACKAGING SPEC GEN. MRKT. PRODUCT CUSTOMER COPY
	DRAFT WHERE APPLICABLE MUST REMAIN WITHIN DIMENSIONS	APPROVED BY DATE JNORTHRO 2012/11/26	MATERIAL NO. SEE TABLE	MOLEX MOLEX INCORPORATED DOCUMENT NO. SD-31301-053	SHEET NO. 1 OF 2
	THIS DRAWING CONTAINS INFORMATION THAT IS PROPRIETARY TO MOLEX INCORPORATED AND SHOULD NOT BE USED WITHOUT WRITTEN PERMISSION				
	SIZE C				

PACKAGING DATA											
PRODUCT DESCRIPTION	CTX 64				CTX 150			CTX 280 SEALED			
PRODUCT P/N SERIES	0348030*** 0348031*** 0348032***		0348033*** 0348035***		034805****			034808****			
GRIP CODE	S	L	S	L	S	M	L	VS	S	M	L
PART WT (Kg/1000)	.1552	.1642	.126	.126	.3070	.3270	.3470	.6596	.6886	.7106	.7332
STAND PACK QTY (SPQ)	60000	60000	60000	60000	35000	30000	25000	10000	10000	10000	10000
QTY/REEL	10000	10000	10000	10000	7000	6000	5000	2000	2000	2000	2000
REELS/SHIPPER CARTON	6	6	6	6	5	5	5	5	5	5	5
CARTONS/PALLET (MAX)	5	5	5	5	5	5	5	5	5	5	5
FILLED CARTON WT (Kg)	14.83	15.37	TBD	TBD	15.64	14.70	13.57	11.5	11.8	12.0	12.2
FLANGE DIAMETER (MM)	610	610	610	610	610	610	610	610	610	610	610

CUSTOMER COPY

SPQ CORRECTION EC NO: UAU2015-0955 DRWN:PPHELPS 2014/12/19 CHKD: APPR: JNORTHRO 2015/01/26 REV: 4	DESCRIPTION JNORTHRO	QUALITY SYMBOLS	GENERAL TOLERANCES (UNLESS SPECIFIED) <table border="1"> <tr> <td></td> <td>mm</td> <td>INCH</td> </tr> <tr> <td>4 PLACES</td> <td>± .---</td> <td>± .---</td> </tr> <tr> <td>3 PLACES</td> <td>± .---</td> <td>± .---</td> </tr> <tr> <td>2 PLACES</td> <td>± .---</td> <td>± .---</td> </tr> <tr> <td>1 PLACE</td> <td>± .---</td> <td>± .---</td> </tr> </table>		mm	INCH	4 PLACES	± .---	± .---	3 PLACES	± .---	± .---	2 PLACES	± .---	± .---	1 PLACE	± .---	± .---	DIMENSION STYLE	SCALE	DESIGN UNITS	THIRD ANGLE PROJECTION
				mm	INCH																	
		4 PLACES		± .---	± .---																	
		3 PLACES		± .---	± .---																	
2 PLACES	± .---	± .---																				
1 PLACE	± .---	± .---																				
DIMENSION STYLE MM ONLY	1:15	METRIC	TITLE																			
		DRAWN BY PPHELPS	DATE 2012/10/24	CTX PACKAGING SPEC GEN. MRKT. PRODUCT CUSTOMER COPY																		
		CHECKED BY	DATE																			
		APPROVED BY JNORTHRO	DATE 2012/11/26	MOLEX INCORPORATED DOCUMENT NO. SD-31301-053																		
		MATERIAL NO. SEE TABLE						SHEET NO. 2 OF 2														
		DRAFT WHERE APPLICABLE MUST REMAIN WITHIN DIMENSIONS																				
		THIS DRAWING CONTAINS INFORMATION THAT IS PROPRIETARY TO MOLEX INCORPORATED AND SHOULD NOT BE USED WITHOUT WRITTEN PERMISSION																				

TIN CONTACT SHAPE

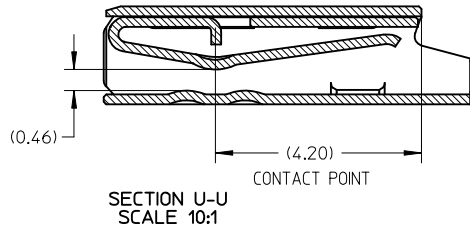
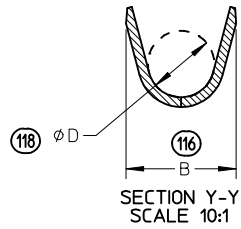

INSULATION GRIP

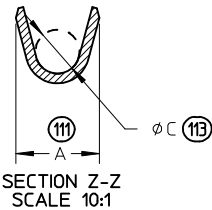

CONDUCTOR GRIP

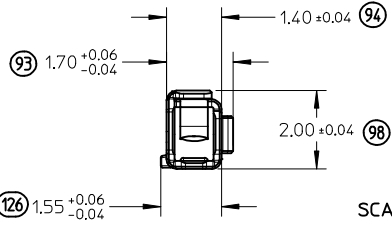

SCALE 8:1

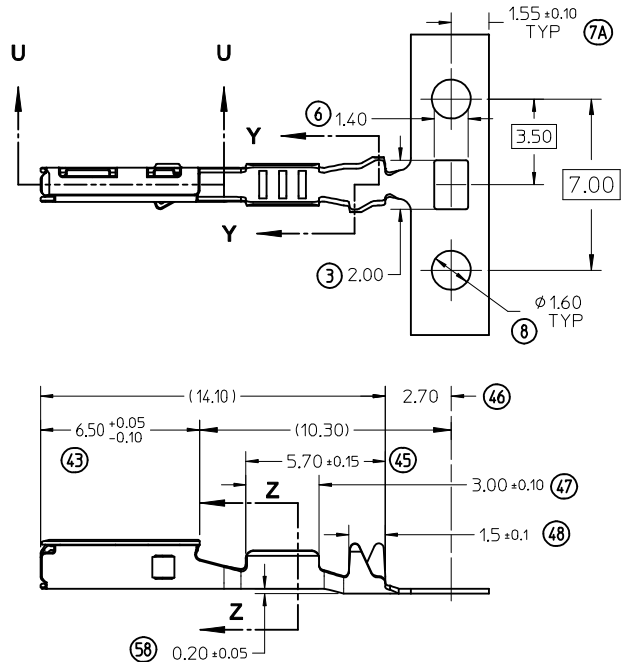

TABLE 1

FAMILY	GENDER	SEALING	PLATING	PART NO	PAYOFF DIRECTION	GRIP CODE	WIRE SIZES*	A ±0.20	B ±0.30	C ±0.10	D ±0.20	SPECIAL CHARACTERISTICS	
CTX64	RECEPTACLE	MAT SEAL	Sn	34803-3211	LEFT (D)	S	22AWG	1.80	2.40	0.90	1.36	STANDARD PERFORMANCE TIN	
				34803-3213	RIGHT (B)	S	0.22-0.35mm²						
				34803-3212	LEFT (D)	L	20AWG						
			Ag	34803-3214	RIGHT (B)	L	0.50-0.85mm²	2.15	2.50	1.20	1.72	STANDARD PERFORMANCE TIN	
				34803-5303	LEFT (D)	S	22AWG	1.80	2.40	0.90	1.36	HIGH PERFORMANCE SILVER	
				34803-5305	LEFT (D)	L	20AWG	2.15	2.50	1.20	1.72	HIGH PERFORMANCE SILVER	
34803-5309	RIGHT (B)	L	0.50-0.85mm²										

* SEE AS-502306-002 FOR SPECIFIC WIRE TYPES



ISO VIEWS NOT TO SCALE

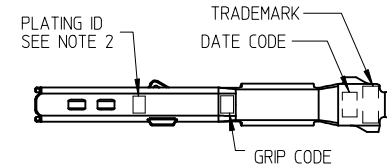

NOTES: (UNLESS OTHERWISE SPECIFIED)

- MATERIAL: COPPER ALLOY
- PLATING MARK: TIN (Sn) - NO MARK
SILVER (Ag) - A
- PACKAGING PER SD-31301-053
- CRIMPING PER AS-502306-002
- PROBING AT ANY LOCATION ON THE TERMINAL BEAM IS NOT PERMITTED
- PRODUCT SPECIFICATION PER PS-502306-001
- ANTI-TARNISH TREATMENT FOR SILVER PLATED AREA: SYNTHETIC HYDROCARBON CONTACT SURFACE FINISH OR EQUIVALENT

SILVER CONTACT SHAPE

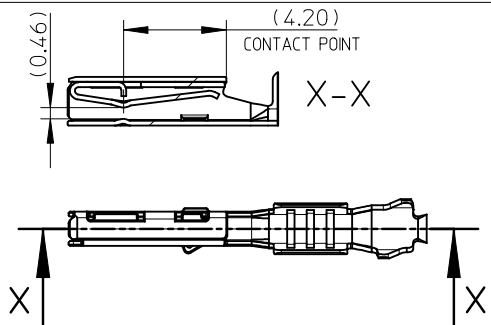
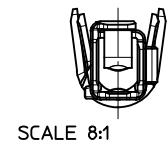

ADD SILVER CONTACT P/N EC NO: GZ016-0163 DRWN:VJOUAS 2016/06/06 CHKD:BMOSER 2016/06/06 APPR:OPLESSIS 2016/06/13 B	QUALITY SYMBOLS F=0 E=0 F=0	GENERAL TOLERANCES (UNLESS SPECIFIED) mm INCH 4 PLACES ± --- ± --- 3 PLACES ± --- ± --- 2 PLACES ± 0.08 ± --- 1 PLACE ± 0.08 ± --- 0 PLACE ± --- ± --- ANGULAR ± 1 ° DRAFT WHERE APPLICABLE MUST REMAIN WITHIN DIMENSIONS	DIMENSION STYLE MM ONLY DRAWN BY DATE AKARANA 2013/03/05 CHECKED BY DATE ADHIR 2013/06/05 APPROVED BY DATE BMOSER 2013/06/27	SCALE 5:1 DESIGN UNITS METRIC THIRD ANGLE PROJECTION	TITLE CTX64 RECEPTACLE TERMINAL	MATERIAL NO. SEE TABLE	DOCUMENT NO. SD-34803-002	SHEET NO. 1 OF 1
	THIS DRAWING CONTAINS INFORMATION THAT IS PROPRIETARY TO MOLEX INCORPORATED AND SHOULD NOT BE USED WITHOUT WRITTEN PERMISSION							
	molex							
	TB_FRAME_B_P_AMLT Rev. G 2012/01/11							