

316390-7 ✓ ACTIVE

AMP | Multilock Connector System

TE Internal #: 316390-7

Automotive Seals & Cavity Plugs, PBT, Yellow, -40 – 105 °C [-40 – 221 °F], Multilock Connector System

[View on TE.com >](#)



Connectors > Automotive Connectors > Seals & Cavity Plugs



Seal Material: **PBT**

Operating Temperature (Max): **65 °C, 70 °C, 75 °C, 80 °C, 85 °C, 90 °C, 100 °C, 105 °C** [149 °F, 158 °F, 167 °F, 176 °F, 185 °F, 194 °F, 212 °F, 221 °F]

Contains Lubricant: **No**

Primary Product Color: **Yellow**

Operating Temperature Range: **-40 – 105 °C** [-40 – 221 °F]

Features

Body Features

Seal Material	PBT
Primary Product Color	Yellow

Usage Conditions

Operating Temperature (Max)	65 °C, 70 °C, 75 °C, 80 °C, 85 °C, 90 °C, 100 °C, 105 °C [149 °F][158 °F][167 °F][176 °F][185 °F][194 °F][212 °F][221 °F]
Operating Temperature Range	-40 – 105 °C[-40 – 221 °F]

Packaging Features

Packaging Quantity	1000
Packaging Method	Bag

Other

Contains Lubricant	No
--------------------	----

Product Compliance

[For compliance documentation, visit the product page on TE.com>](#)

EU RoHS Directive 2011/65/EU	Compliant
EU ELV Directive 2000/53/EC	Compliant
China RoHS 2 Directive MIIT Order No 32, 2016	No Restricted Materials Above Threshold
EU REACH Regulation (EC) No. 1907/2006	



Current ECHA Candidate List: JUNE 2022
 (224)
 Candidate List Declared Against: JAN 2022
 (223)
 SVHC > Threshold:
 Not Yet Reviewed

Halogen Content
 BFR/CFR/PVC Free, but Br/Cl >900 ppm in other sources.

Solder Process Capability
 Not applicable for solder process capability

Product Compliance Disclaimer

This information is provided based on reasonable inquiry of our suppliers and represents our current actual knowledge based on the information they provided. This information is subject to change. The part numbers that TE has identified as EU RoHS compliant have a maximum concentration of 0.1% by weight in homogenous materials for lead, hexavalent chromium, mercury, PBB, PBDE, DBP, BBP, DEHP, DIBP, and 0.01% for cadmium, or qualify for an exemption to these limits as defined in the Annexes of Directive 2011/65/EU (RoHS2). Finished electrical and electronic equipment products will be CE marked as required by Directive 2011/65/EU. Components may not be CE marked. Additionally, the part numbers that TE has identified as EU ELV compliant have a maximum concentration of 0.1% by weight in homogenous materials for lead, hexavalent chromium, and mercury, and 0.01% for cadmium, or qualify for an exemption to these limits as defined in the Annexes of Directive 2000/53/EC (ELV). Regarding the REACH Regulation, the information TE provides on SVHC in articles for this part number is based on the latest European Chemicals Agency (ECHA) 'Guidance on requirements for substances in articles' posted at this URL: <https://echa.europa.eu/guidance-documents/guidance-on-reach>

Compatible Parts



Also in the Series | Multilock Connector System

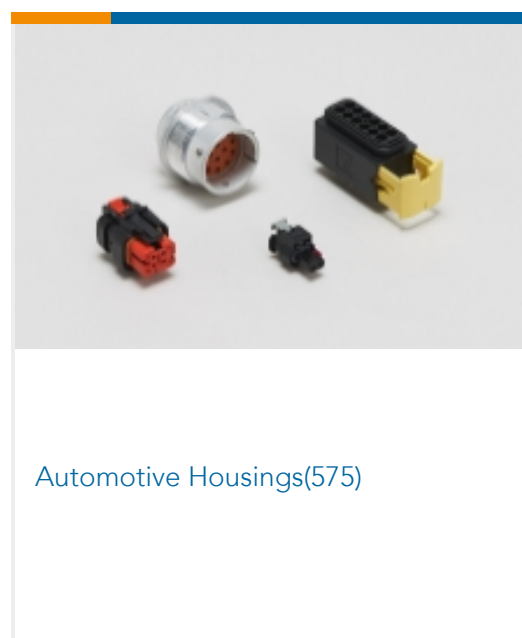
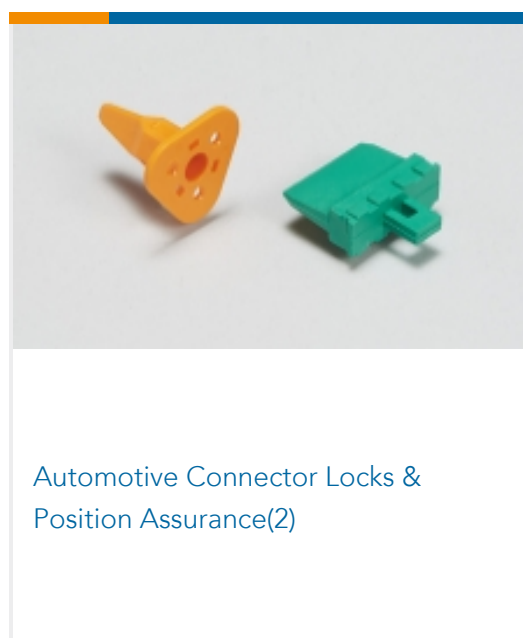
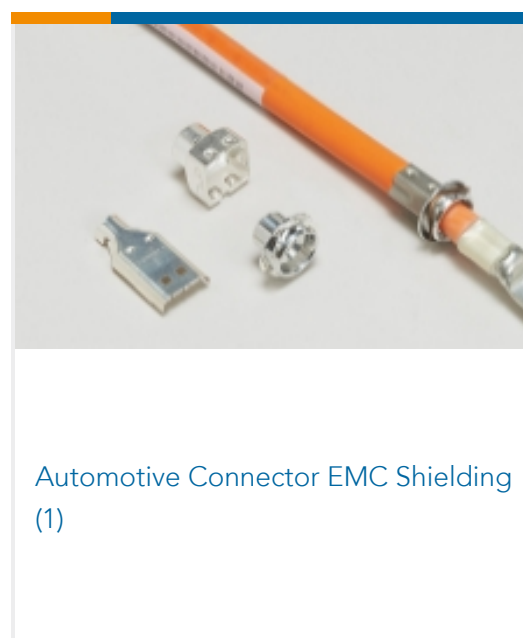



Automotive Seals & Cavity Plugs(2)



Automotive Terminals(140)

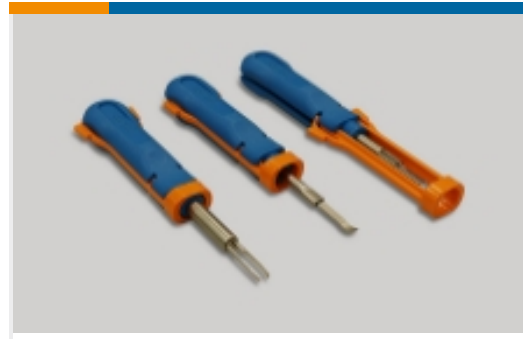

Insertion & Extraction Tools(6)



Other Automotive Connector Accessories(9)

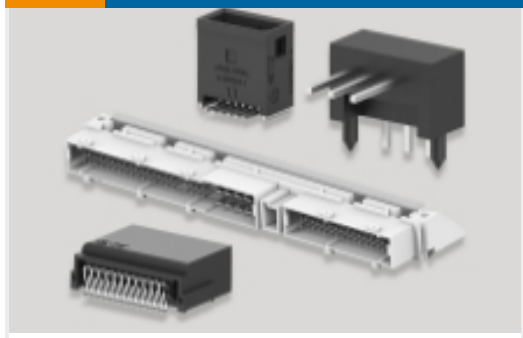

PCB Headers & Receptacles(129)

Customers Also Bought

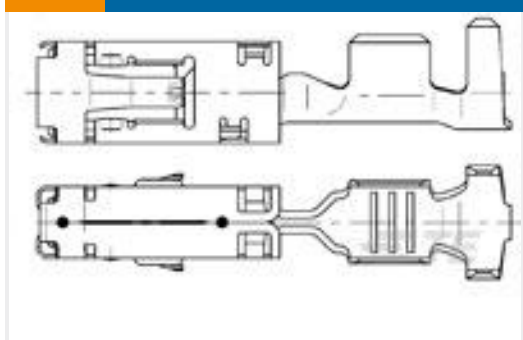

TE Part #967543-1
SENSOR FLA-KONT 2,8



TE Part #2-2112780-1
18POS, MIXED,REC HSG,ASSY,
SEALED



TE Part #2237049-1
0.64 III 16P PLUG ASSEMBLY



TE Part #2822363-4
EJ-2 DBL LOCK PLUG 2P ASSY B
LIGHT GRAY

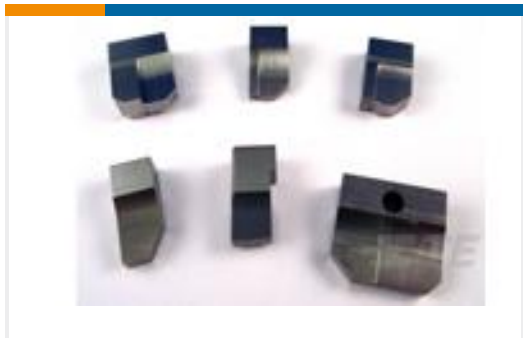

TE Part #3-1803000-1
ANVIL, COMBINATION, END FEED



TE Part #170014-5
FF 110 TAB 20-16AWG BR



TE Part #170801-4
FF 110 REC HSG 4P NYLON NATURAL



TE Part #2112758-1
COVER

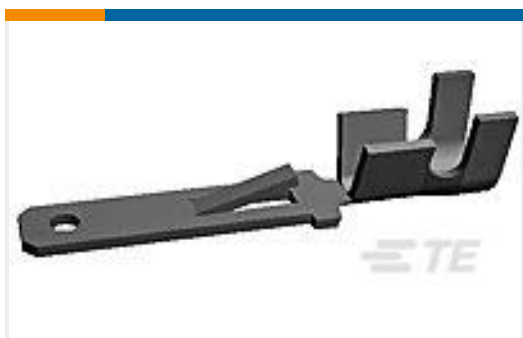

TE Part #170058-1
FF 110 TAB 24-20AWG BR



TE Part #178448-7
EJ-II DBL LOCK 2POS PLUG ASSY

Documents



Product Drawings

CAVITY PLUG FOR MINI M/LOCK

English

CAD Files

3D PDF

English

Customer View Model

ENG_CVM_316390-7_A.2d_dxf.zip

English

Customer View Model

ENG_CVM_316390-7_A.3d_igs.zip

English

Customer View Model

ENG_CVM_316390-7_A.3d_stp.zip

English

By downloading the CAD file I accept and agree to the [Terms and Conditions](#) of use.

Product Specifications

Application Specification

English

CRIMPING OF MINI-MULTI-LOCK CONNECTOR CONTACTS

English

Product Environmental Compliance

MD_316390-7_0226201324_dmtec

English

MD_316390-7_0226201324_dmtec

English