

282191-2 ✓ ACTIVE

Timer Connector System

TE Internal #: 282191-2

TE Internal Description: SPLASH PROOF CONN. W.S.L.

TIMER, CONNECTOR HOUSING

[View on TE.com >](#)



All TIMER, CONNECTOR HOUSING (543)

Product Compliance

[For compliance documentation, visit the product page on TE.com>](#)

EU RoHS Directive 2011/65/EU	Compliant
EU ELV Directive 2000/53/EC	Compliant
China RoHS 2 Directive MIIT Order No 32, 2016	No Restricted Materials Above Threshold
EU REACH Regulation (EC) No. 1907/2006	Current ECHA Candidate List: JUNE 2022 (224) Candidate List Declared Against: JUL 2017 (174) SVHC > Threshold: Not Yet Reviewed
Halogen Content	BFR/CFR/PVC Free, but Br/Cl >900 ppm in other sources.
Solder Process Capability	Not applicable for solder process capability

Product Compliance Disclaimer

This information is provided based on reasonable inquiry of our suppliers and represents our current actual knowledge based on the information they provided. This information is subject to change. The part numbers that TE has identified as EU RoHS compliant have a maximum concentration of 0.1% by weight in homogenous materials for lead, hexavalent chromium, mercury, PBB, PBDE, DBP, BBP, DEHP, DIBP, and 0.01% for cadmium, or qualify for an exemption to these limits as defined in the Annexes of Directive 2011/65/EU (RoHS2). Finished electrical and electronic equipment products will be CE marked as required by Directive 2011/65/EU. Components may not be CE marked. Additionally, the part numbers that TE has identified as EU ELV compliant have a maximum concentration of 0.1% by weight in homogenous materials for lead, hexavalent chromium, and mercury, and 0.01% for cadmium, or qualify for an exemption to these limits as defined in the Annexes of Directive 2000/53/EC (ELV). Regarding the REACH Regulation, the information TE provides on SVHC in articles for this part number is based on the latest European Chemicals Agency (ECHA) 'Guidance on requirements for substances in articles' posted at this URL: <https://echa.europa.eu/guidance-documents/guidance-on-reach>

Compatible Parts



TE Part # 828905-1
SINGLE-WIRE-SEAL(5MM HOLE)



TE Part # 828904-1
SINGLE WIRE SEAL FOR J.P.T.CON



TE Part # 828906-2
BLINDSTOPFEN 1,5SYS



TE Part # 1-962581-2
FLACHST-GH2,8 EDS3P



TE Part # CAT-T4827-T273
TIMER, RECEPTACLE AND TAB

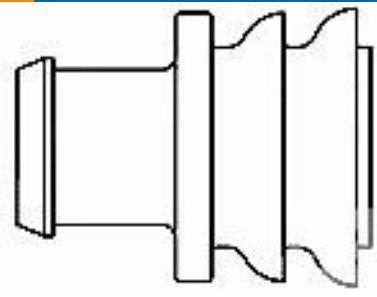

TE Part # 282536-1
S.WAY SEAL F.JPT CONTACT 2.5MM



TE Part # 828906-1
CAVITY PLUG (5MM HOLE)



TE Part # 1-929937-1
JPT REC 2.8 Contact SWS Au

Also in the Series | Timer Connector System



Automotive Connector Caps & Covers (11)



Automotive Connector Locks & Position Assurance(16)



Automotive Housings(219)



Automotive Seals & Cavity Plugs(31)



Automotive Terminals(140)

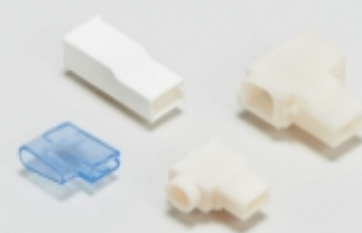

Crimp Terminal Housings(13)



Insertion & Extraction Tools(20)



Other Automotive Connector Accessories(1)



PCB Headers & Receptacles(78)



Quick Disconnects(4)

Customers Also Bought



TE Part #1-967623-1
TIMER, CONNECTOR HOUSING



TE Part #953697-3
3POS MQS REC



TE Part #2176413-3
5W XSM M/OX 5% 82K



TE Part #HD36-24-47SE-072
PLG, 47P, AL, E, THD ADPT DRAIN, 16 /20,S



TE Part #HDP26-24-9PE-L017
PLG, 9P, BLK, E, RNG, 4/8/12, P

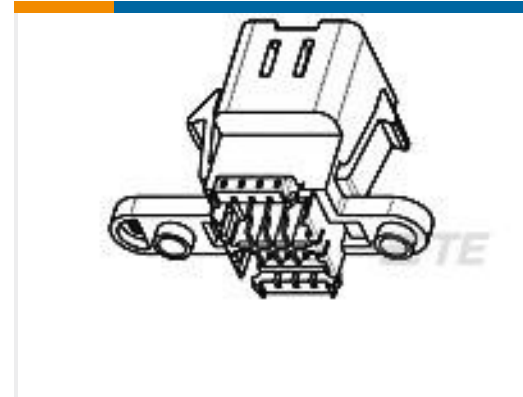

TE Part #176121-2
.040 MULTI-LOCK 8 POS



TE Part #1587723-1
INNER FERRULE, SIZE A, HVA280



TE Part #2-2176251-0
CRGS2010 5% 39R

Documents

Product Drawings

SPLASH PROOF CONN. W.S.L.

English

CAD Files

3D PDF

3D

Customer View Model

[ENG_CVM_CVM_282191-2_P_c-282191-2-p.2d_dxf.zip](#)

English

Customer View Model

[ENG_CVM_CVM_282191-2_P_c-282191-2-p.3d_igs.zip](#)

English

Customer View Model

[ENG_CVM_CVM_282191-2_P_c-282191-2-p.3d_stp.zip](#)

English

By downloading the CAD file I accept and agree to the [Terms and Conditions](#) of use.

Datasheets & Catalog Pages

Timer Interconnection System

English

Product Specifications

Product Specification

English

Connecteurs 2, 3 et 5 Voies Etanches Junior Power Timer

English



[Product Specification](#)

English

[Instruction Sheets](#)

[2-7 positions junior power timer splash proof connectors](#)

English

[Instruction Sheet \(non U.S.\)](#)

English