



Connectors > Automotive Connectors > Connector Housings > TIMER, CONNECTOR HOUSING



Connector & Housing Type: **Housing for Female Terminals**

Mating Tab Width: **3 mm [.118 in]**

Connector System: **Wire-to-Wire**

Number of Positions: **2**

Centerline (Pitch): **5 mm [.197 in]**

[All TIMER, CONNECTOR HOUSING \(543\)](#)

Features

Product Type Features

Connector & Housing Shape	Rectangular
Connector & Housing Type	Housing for Female Terminals
Connector System	Wire-to-Wire
Sealable	Yes
Hybrid Connector	No
Primary Locking Feature	On the Terminal

Configuration Features

Number of Positions	2
Number of Rows	1

Electrical Characteristics

Operating Voltage	24 VDC
Nominal Voltage Architecture	12 V, 24 V

Body Features

Cable Exit Angle	180°
Body Material	PA
Primary Product Color	Green

Contact Features



Contact Size	2.8mm
Contact Type	Receptacle
Mating Tab Width	3 mm[.118 in]

Mechanical Attachment

Mounting Feature	Without
Terminal Position Assurance	Yes
Strain Relief	Without
Mating Alignment Type	Polarization Slot
Mating Alignment	With
Connector Mounting Type	Cable Mount (Free-Hanging)

Housing Features

Centerline (Pitch)	5 mm[.197 in]
--------------------	---------------

Dimensions

Product Width	22 mm[.866 in]
Product Length	23.8 mm[.937 in]
Product Height	37.5 mm[1.476 in]

Usage Conditions

Operating Temperature (Max)	70 °C, 75 °C, 80 °C, 85 °C, 90 °C, 100 °C, 105 °C, 110 °C, 120 °C, 125 °C[158 °F][167 °F][176 °F][185 °F][194 °F][212 °F][221 °F][230 °F][248 °F][257 °F]
Operating Temperature Range	-30 – 125 °C[-22 – 257 °F]

Operation/Application

Circuit Application	Signal
---------------------	--------

Packaging Features

Packaging Method	Bag
------------------	-----

Other

Serviceable	No
Connector Position Assurance Capable	No

Product Compliance

[For compliance documentation, visit the product page on TE.com>](#)

EU RoHS Directive 2011/65/EU	Compliant
------------------------------	-----------







EU ELV Directive 2000/53/EC	Compliant
China RoHS 2 Directive MIIT Order No 32, 2016	No Restricted Materials Above Threshold
EU REACH Regulation (EC) No. 1907/2006	Current ECHA Candidate List: JUNE 2022 (224) Candidate List Declared Against: JAN 2022 (223) SVHC > Threshold: Not Yet Reviewed
Halogen Content	BFR/CFR/PVC Free, but Br/Cl >900 ppm in other sources.
Solder Process Capability	Not applicable for solder process capability

Product Compliance Disclaimer

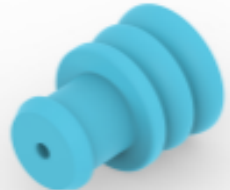
This information is provided based on reasonable inquiry of our suppliers and represents our current actual knowledge based on the information they provided. This information is subject to change. The part numbers that TE has identified as EU RoHS compliant have a maximum concentration of 0.1% by weight in homogenous materials for lead, hexavalent chromium, mercury, PBB, PBDE, DBP, BBP, DEHP, DIBP, and 0.01% for cadmium, or qualify for an exemption to these limits as defined in the Annexes of Directive 2011/65/EU (RoHS2). Finished electrical and electronic equipment products will be CE marked as required by Directive 2011/65/EU. Components may not be CE marked. Additionally, the part numbers that TE has identified as EU ELV compliant have a maximum concentration of 0.1% by weight in homogenous materials for lead, hexavalent chromium, and mercury, and 0.01% for cadmium, or qualify for an exemption to these limits as defined in the Annexes of Directive 2000/53/EC (ELV). Regarding the REACH Regulation, the information TE provides on SVHC in articles for this part number is based on the latest European Chemicals Agency (ECHA) 'Guidance on requirements for substances in articles' posted at this URL: <https://echa.europa.eu/guidance-documents/guidance-on-reach>

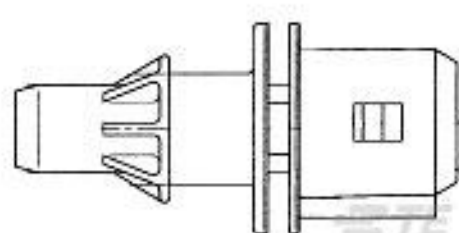
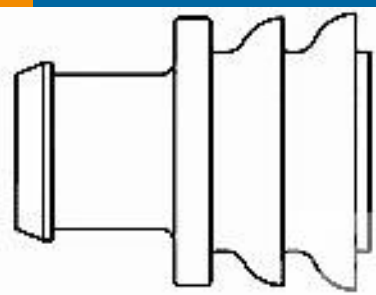
Compatible Parts

 <p>TE Part # 828905-1 SINGLE-WIRE-SEAL(5MM HOLE)</p>	 <p>TE Part # 828904-1 SINGLE WIRE SEAL FOR J.P.T.CON</p>	 <p>TE Part # 828906-2 BLINDSTOPFEN 1,5SYS</p>	 <p>TE Part # CAT-T4827-T273 TIMER, RECEPTACLE AND TAB</p>
 <p>TE Part # 106462-1 2P.FASTIN-ON HSG.</p>	 <p>TE Part # 282536-1 S.WAY SEAL F.JPT CONTACT 2.5MM</p>	 <p>TE Part # 828906-1 CAVITY PLUG (5MM HOLE)</p>	 <p>TE Part # 1-929937-1 JPT REC 2.8 Contact SWS Au</p>

Also in the Series | Timer Connector System



Automotive Connector Caps & Covers (11)



Automotive Connector Locks & Position Assurance(16)



Automotive Housings(219)



Automotive Seals & Cavity Plugs(31)



Automotive Terminals(140)



Crimp Terminal Housings(13)



Insertion & Extraction Tools(20)



Other Automotive Connector Accessories(1)



PCB Headers & Receptacles(78)

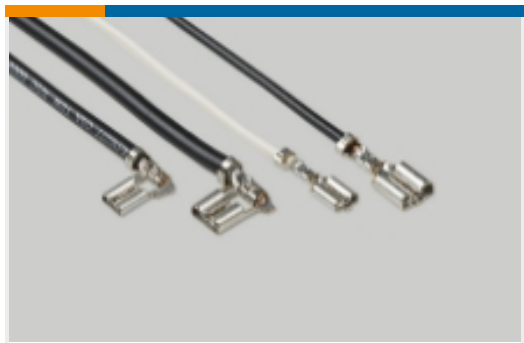

Quick Disconnects(4)

Customers Also Bought

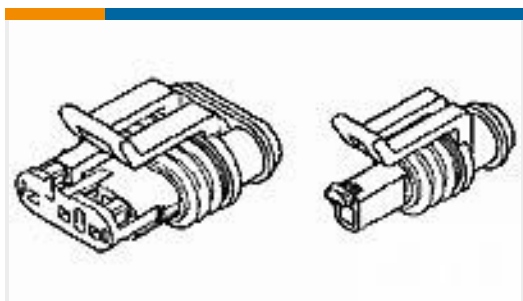

TE Part #282080-3
AMP SUPERSEAL 1.5 SERIES 2P PL



TE Part #178483-1
UP 3.96 6P PLUG HSG NATRL



TE Part #965082-1
2X 2P LOCK-CLIP GEH

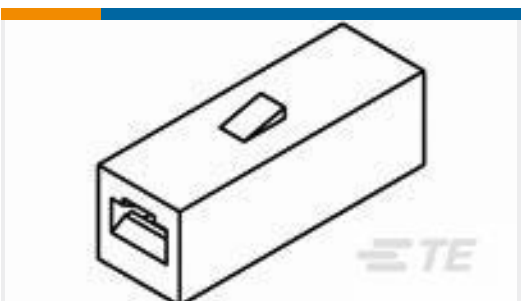

TE Part #626062
FASTIN-ON HOUSING REC PA66 NATURAL

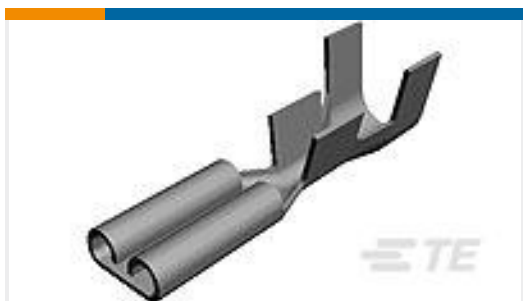

TE Part #61408-1
110 FASTON REC 20-16 AWG TPBR



TE Part #350865-1
01P UMNL PLUG HSG

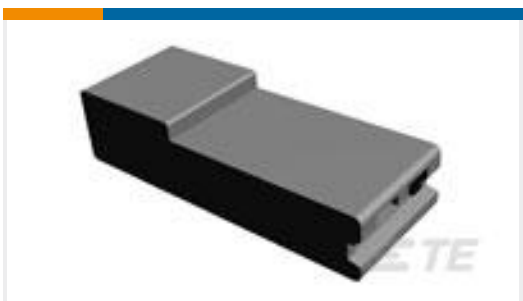

TE Part #926539-5
250 FASTON HSG. REC. 1P BLACK



TE Part #282764-1
JPT SPLASH-PROOF FEM.CONN4 POS

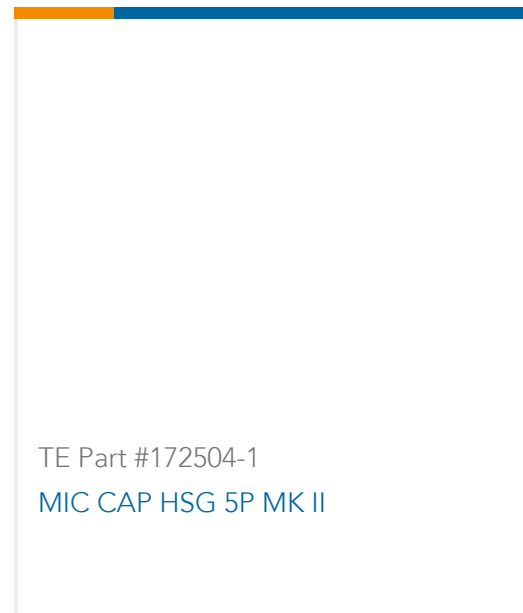

Documents

Product Drawings

[SPLASH PROOF CONN. W.S.L.](#)

English

CAD Files

[3D PDF](#)

3D

Customer View Model

[ENG_CVM_CVM_282189-4_M_c-282189-4-m.2d_dxf.zip](#)

English

Customer View Model

[ENG_CVM_CVM_282189-4_M_c-282189-4-m.3d_igs.zip](#)

English

Customer View Model

[ENG_CVM_CVM_282189-4_M_c-282189-4-m.3d_stp.zip](#)

English

By downloading the CAD file I accept and agree to the [Terms and Conditions](#) of use.

Datasheets & Catalog Pages

[Timer Interconnection System](#)

English

Product Specifications

[Product Specification](#)

English

Instruction Sheets

[2-7 positions junior power timer splash proof connectors](#)

English

[Instruction Sheet \(non U.S.\)](#)

English