



Terminals & Splices > Quick Disconnects



Quick Disconnect Terminal Type: **Receptacle**

Wire Size: **4 – 6.63 mm<sup>2</sup>**

Mating Tab Width: **9.53 mm [ .375 in ]**

Mating Tab Thickness: **1.22 mm [ .048 in ]**

## Features

### Product Type Features

Terminates To	Wire & Cable
Wire Stop	No
Wire/Cable Type	Regular Wire
Sealable	No

### Configuration Features

Connection Capacity	Single
---------------------	--------

### Contact Features

Quick Disconnect Terminal Type	Receptacle
Mating Tab Width	9.53 mm [.375 in]
Mating Tab Thickness	1.22 mm [.048 in]
Terminal Orientation	Straight
Contact Base Material	Brass
Terminal Plating Material	Tin
Crimp Type	F-Crimp
Barrel Type	Open



### Mechanical Attachment

Mating Retention Type	Dimple
Wire Insulation Support	With

### Dimensions

Accepts Wire Insulation Diameter Range	3.81 – 5.08 mm [.15 – .2 in]
Overall Length	27.2 mm [1.07 in]
Receptacle Terminal Stock Thickness	.51 mm [.02 in]
Wire Size	4 – 6.63 mm <sup>2</sup>

### Usage Conditions

Insulation Option	Uninsulated
Operating Temperature Range	-40 – 110 °C [-40 – 230 °F]

### Industry Standards

UL Rating	Listed
CSA Certified	Yes

### Packaging Features

Packaging Quantity	2000
Packaging Method	Strip/Reel

### Product Compliance

[For compliance documentation, visit the product page on TE.com>](#)

EU RoHS Directive 2011/65/EU	Compliant
EU ELV Directive 2000/53/EC	Compliant
China RoHS 2 Directive MIIT Order No 32, 2016	No Restricted Materials Above Threshold
EU REACH Regulation (EC) No. 1907/2006	Current ECHA Candidate List: JUNE 2022 (224) Candidate List Declared Against: JAN 2022 (223) SVHC > Threshold: Not Yet Reviewed
Halogen Content	Low Halogen - Br, Cl, F, I < 900 ppm per homogenous material. Also BFR/CFR/PVC Free
Solder Process Capability	Not applicable for solder process capability

Product Compliance Disclaimer

This information is provided based on reasonable inquiry of our suppliers and represents our current actual knowledge based on the information they provided. This information is subject to change. The part numbers that TE has identified as EU RoHS compliant have a maximum concentration of 0.1% by weight in homogenous materials for lead, hexavalent chromium, mercury, PBB, PBDE, DBP, BBP, DEHP, DIBP, and 0.01% for cadmium, or qualify for an exemption to these limits as defined in the Annexes of Directive 2011/65/EU (RoHS2). Finished electrical and electronic equipment products will be CE marked as required by Directive 2011/65/EU. Components may not be CE marked. Additionally, the part numbers that TE has identified as EU ELV compliant have a maximum concentration of 0.1% by weight in homogenous materials for lead, hexavalent chromium, and mercury, and 0.01% for cadmium, or qualify for an exemption to these limits as defined in the Annexes of Directive 2000/53/EC (ELV). Regarding the REACH Regulation, the information TE provides on SVHC in articles for this part number is based on the latest European Chemicals Agency (ECHA) 'Guidance on requirements for substances in articles' posted at this URL: <https://echa.europa.eu/guidance-documents/guidance-on-reach>

## Compatible Parts



## Also in the Series | FASTON 375

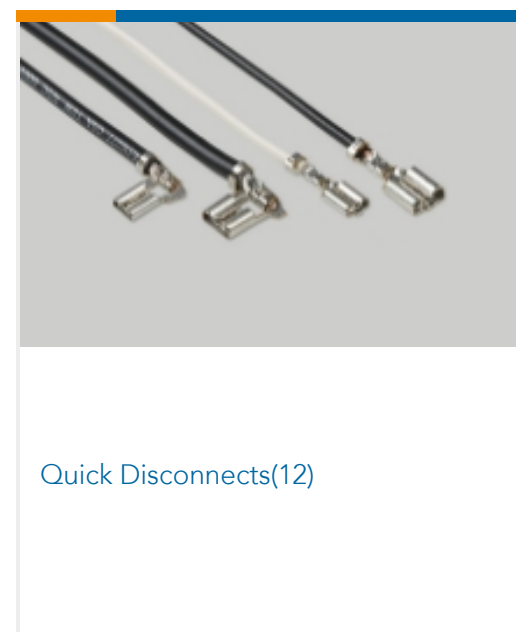
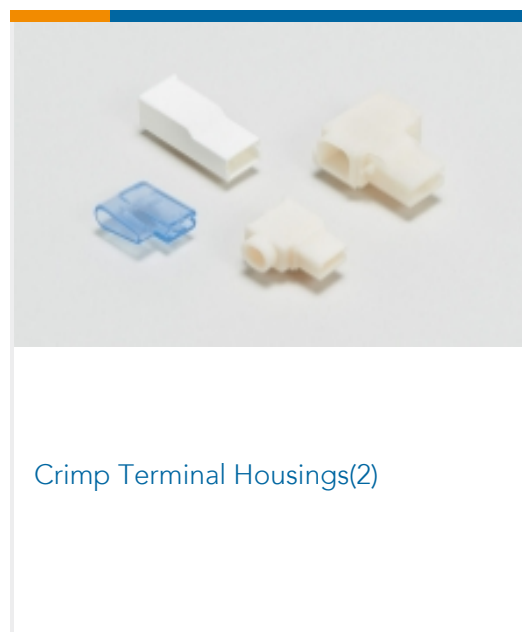

## Customers Also Bought

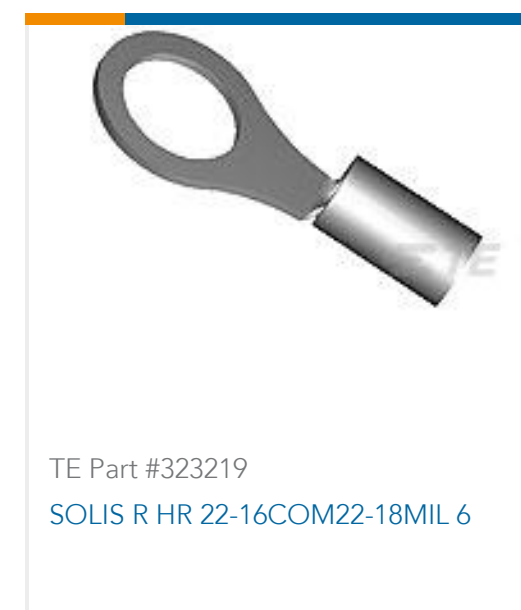
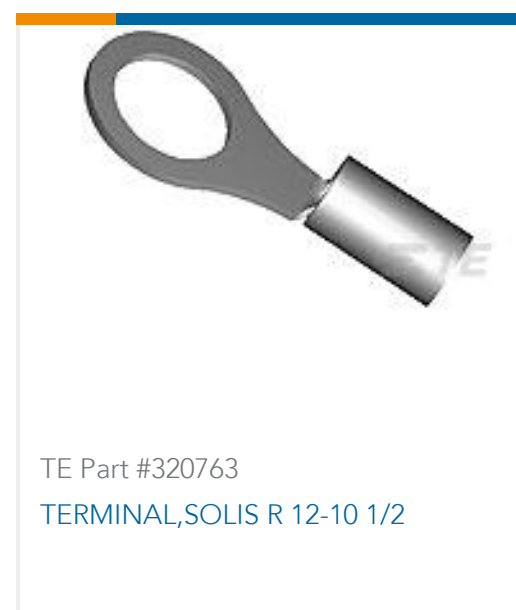

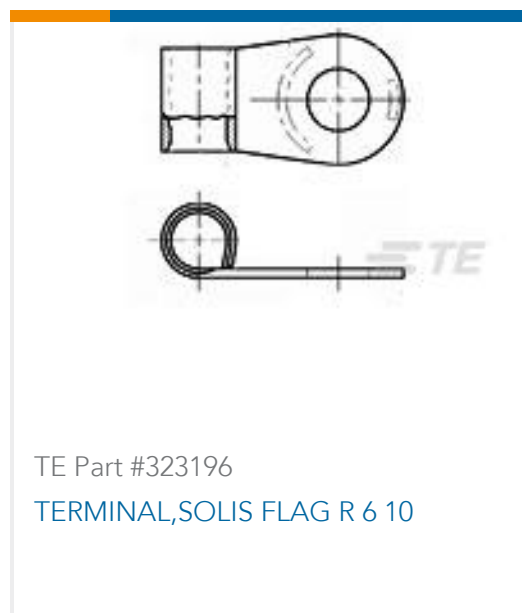
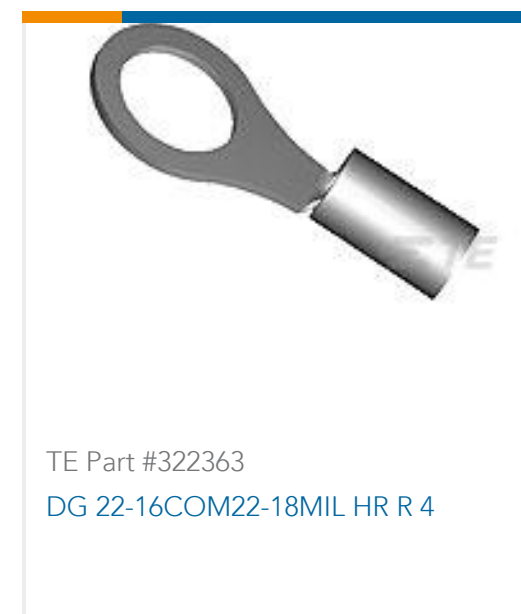
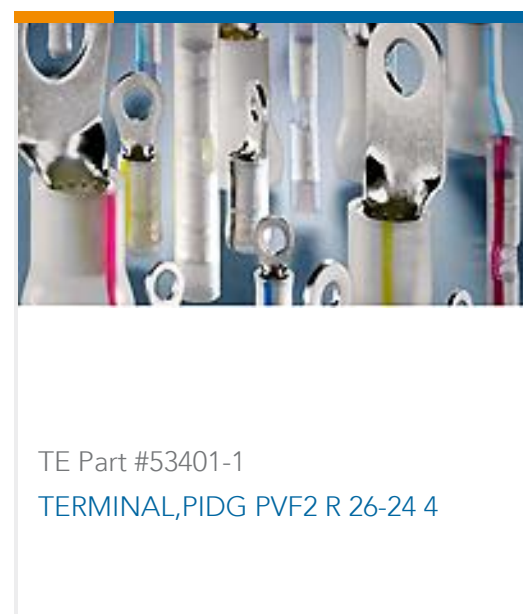

## Documents

### Product Drawings

[FASTON 375 ASY REC 4-6MM2 0.5X27.0 TPBR](#)

English

### CAD Files

Customer View Model

[ENG\\_CVM\\_CVM\\_280223-2\\_R.2d\\_dxf.zip](#)

English

3D PDF

3D

Customer View Model

[ENG\\_CVM\\_CVM\\_280223-2\\_R.3d\\_igs.zip](#)

English

Customer View Model

[ENG\\_CVM\\_CVM\\_280223-2\\_R.3d\\_stp.zip](#)

English

By downloading the CAD file I accept and agree to the [Terms and Conditions](#) of use.

### Product Specifications

[Title not available for initial StarTEC data load](#)

English

[Application Specification](#)

English

### Product Environmental Compliance

[MD\\_280223-2\\_03162018922\\_dmtec](#)

English

280223-2

Quick Disconnects, Receptacle, 11 – 9 AWG Wire Size, 4 – 6.63 mm<sup>2</sup> Wire Size,  
Mating Tab Width .375 in [9.53 mm], Straight, Brass, FASTON 375



[MD\\_280223-2\\_03162018922\\_dmtec](#)

English