

2238196-3 ✓ ACTIVE

FASTON | FASTON 250

TE Internal #: 2238196-3

Quick Disconnects, Receptacle, 18 – 14 AWG Wire Size, .8 – 2 mm²

Wire Size, 1600 – 4100 CMA Wire Size, Mating Tab Width .25 in

[6.35 mm], FASTON 250

[View on TE.com >](#)



Terminals & Splices > Quick Disconnects

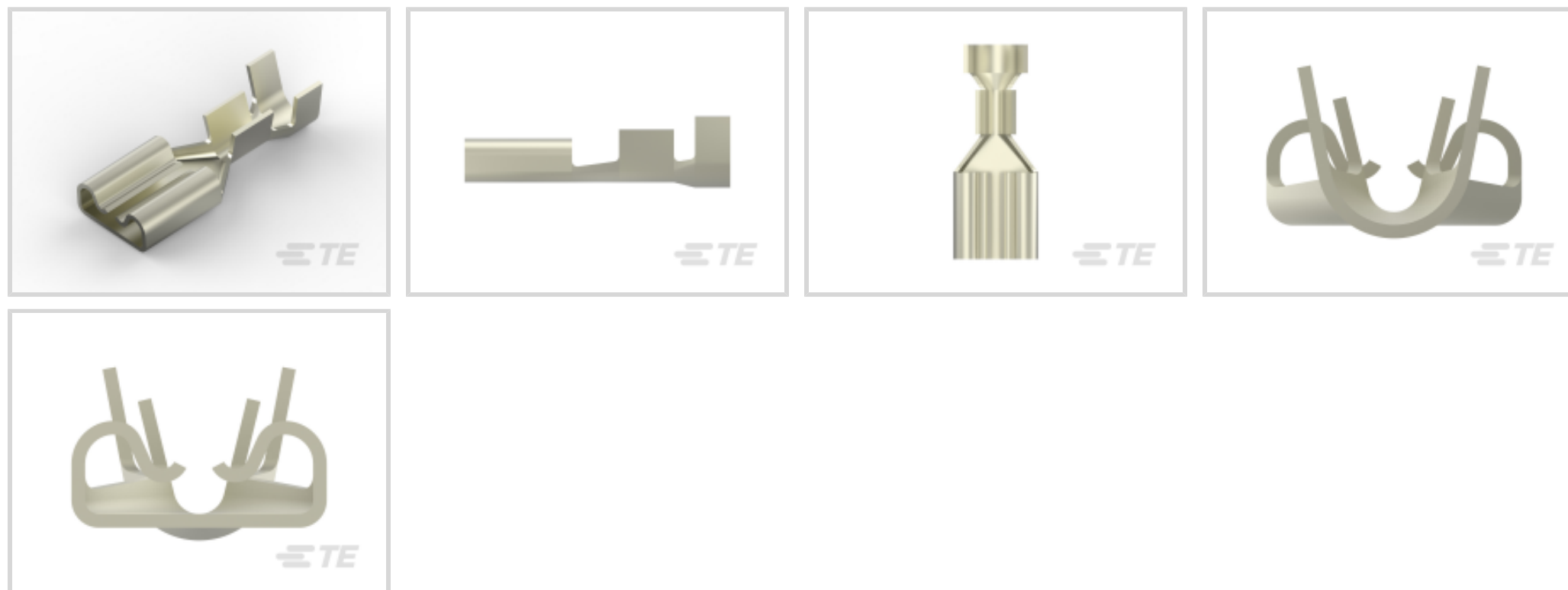

Quick Disconnect Terminal Type: **Receptacle**

Wire Size: **1600 – 4100 CMA**

Mating Tab Width: **6.35 mm [.25 in]**

Features

Product Type Features

Terminates To	Wire & Cable
Wire Stop	No
Wire/Cable Type	Regular Wire
Insertion Force	Low
Sealable	No

Configuration Features

Connection Capacity	Single
---------------------	--------

Contact Features

Quick Disconnect Terminal Type	Receptacle
Mating Tab Width	6.35 mm [.25 in]
Mating Tab Thickness	.81 mm [.032 in]
Terminal Orientation	Straight
Contact Base Material	Brass
Terminal Plating Material	Tin
Crimp Type	F-Crimp



Barrel Type	Open
-------------	------

Mechanical Attachment

Mating Retention Type	Dimple
Wire Insulation Support	With

Dimensions

Accepts Wire Insulation Diameter Range	3.05 – 4.32 mm [.12 – .17 in]
Receptacle Terminal Stock Thickness	.41 mm [.016 in]
Wire Size	1600 – 4100 CMA

Usage Conditions

Insulation Option	Uninsulated
Operating Temperature Range	-40 – 125 °C [-40 – 125 °F]

Packaging Features

Packaging Quantity	10000
Packaging Method	Strip/Reel

Other

Line	FASTON .250
------	-------------

Product Compliance

[For compliance documentation, visit the product page on TE.com>](#)

EU RoHS Directive 2011/65/EU	Compliant
EU ELV Directive 2000/53/EC	Compliant
China RoHS 2 Directive MIIT Order No 32, 2016	No Restricted Materials Above Threshold
EU REACH Regulation (EC) No. 1907/2006	Current ECHA Candidate List: JUNE 2022 (224) Candidate List Declared Against: JAN 2022 (223) SVHC > Threshold: Not Yet Reviewed
Halogen Content	Low Halogen - Br, Cl, F, I < 900 ppm per homogenous material. Also BFR/CFR/PVC Free
Solder Process Capability	Not reviewed for solder process capability

Product Compliance Disclaimer

This information is provided based on reasonable inquiry of our suppliers and represents our current actual knowledge based on the information they provided. This information is subject to change. The part numbers that TE has identified as

EU RoHS compliant have a maximum concentration of 0.1% by weight in homogenous materials for lead, hexavalent chromium, mercury, PBB, PBDE, DBP, BBP, DEHP, DIBP, and 0.01% for cadmium, or qualify for an exemption to these limits as defined in the Annexes of Directive 2011/65/EU (RoHS2). Finished electrical and electronic equipment products will be CE marked as required by Directive 2011/65/EU. Components may not be CE marked. Additionally, the part numbers that TE has identified as EU ELV compliant have a maximum concentration of 0.1% by weight in homogenous materials for lead, hexavalent chromium, and mercury, and 0.01% for cadmium, or qualify for an exemption to these limits as defined in the Annexes of Directive 2000/53/EC (ELV). Regarding the REACH Regulation, the information TE provides on SVHC in articles for this part number is based on the latest European Chemicals Agency (ECHA) 'Guidance on requirements for substances in articles' posted at this URL: <https://echa.europa.eu/guidance-documents/guidance-on-reach>

Compatible Parts





TE Part # 1-1969232-1
250 FASTON HSG., REC., 2 POS,
NATURAL



TE Part # 1-1969232-3
250 FASTON HSG., REC., 2 POS,
YELLOW



TE Part # 1-1969232-4
250 FASTON HSG., REC., 2 POS, GREEN



TE Part # 1-520987-4
250 FASTON HSG., REC., 4 POS, BLACK

Also in the Series | **FASTON 250**



Compression Connectors(4)



Crimp Terminal Housings(143)



Insertion & Extraction Tools(6)



Magnet Wire Terminals(1)



PCB Terminals(144)



Quick Disconnects(456)



Splices(4)

Customers Also Bought



TE Part #521367-2
ULTRA-POD 250 ASSY REC 18-14
AWG TPBR



TE Part #1376395-1
5MM POWER KEY D/L PLATE GREEN



TE Part #42452-2
187 FASTON REC 20-16 AWG TPBR



TE Part #1969825-8
EP 2.5 TPA RETAINER, 8 POS



TE Part #2238207-3
187 FASTON, REC., 20-16 AWG, TPBR

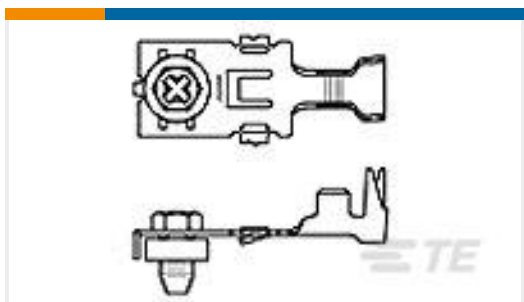

TE Part #521843-1
POWER BLOCK ASSEMBLY 16-12
AWG PTPBR



TE Part #60650-1
250 FASTON FLAG REC 18-14 AWG
BR



TE Part #1969897-1
250 FASTON HSG., REC., 5 POS, BLACK



Documents

Product Drawings

250 FASTON, REC., 18-14 AWG, TPBR

English

CAD Files

3D PDF

3D

Customer View Model

[ENG_CVM_CVM_2238196-3_A.2d_dxf.zip](#)

English

Customer View Model

[ENG_CVM_CVM_2238196-3_A.3d_igs.zip](#)

English

Customer View Model

[ENG_CVM_CVM_2238196-3_A.3d_stp.zip](#)

English

By downloading the CAD file I accept and agree to the [Terms and Conditions](#) of use.

Datasheets & Catalog Pages

1-1773948-2 Standard Line FASTON Receptacles QRG

English

Product Specifications

Product Specification

English

FASTON, .250 STD. REC. TEST REPORT

English

Product Environmental Compliance

TE Material Declaration

English