

Data sheet | Item number: 250-424

PCB terminal block; push-button; 0.5 mm²; Pin spacing 2.5 mm; 24-pole;
Push-in CAGE CLAMP®; 0,50 mm²; gray

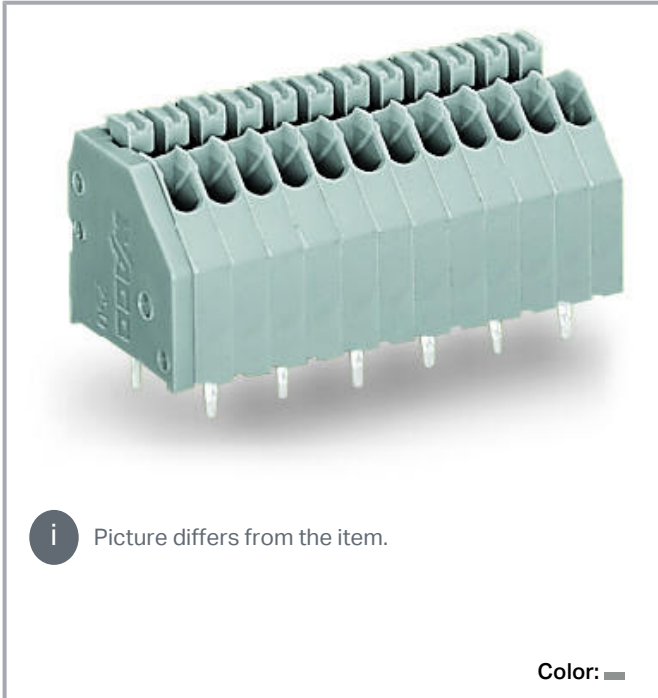

www.wago.com/250-424



i Picture differs from the item.

Color:

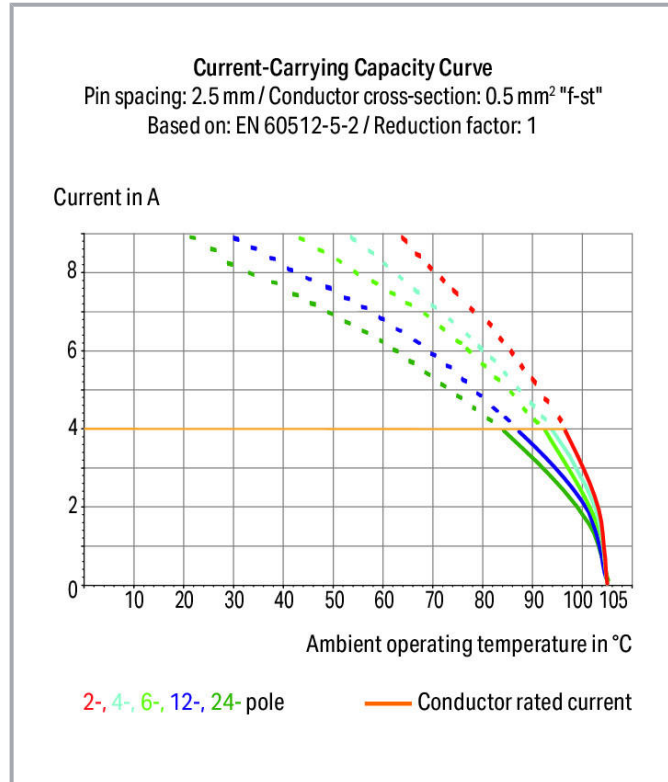

Subject to changes. Please also observe the further product documentation!

WAGO Kontakttechnik GmbH & Co. KG
Hansastr. 27
32423 Minden
Phone: +49571 887-0 | Fax: +49571 887-169
Email: info.de@wago.com | Web: www.wago.com

Do you have any questions about our products?
We are always happy to take your call at +49 (571) 887-44222.

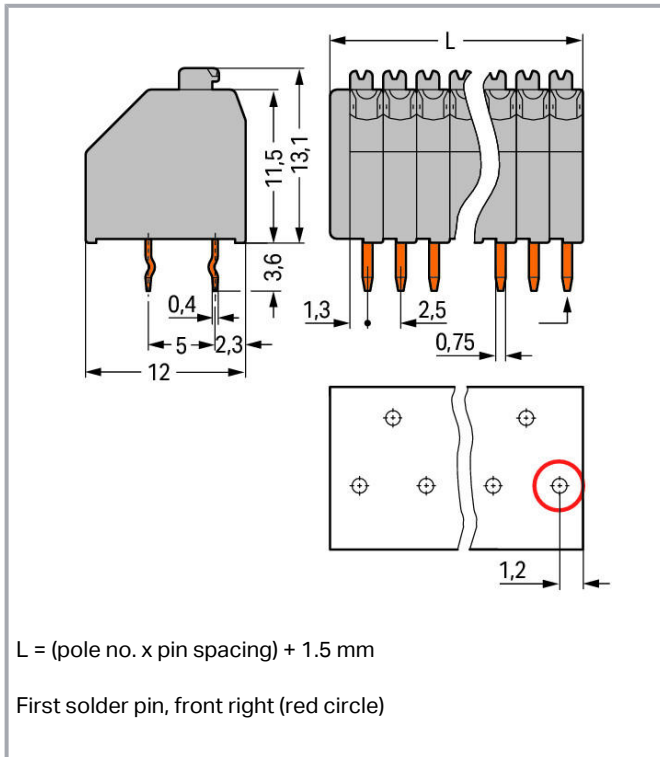

Item description

- Compact PCB terminal strips with push-buttons
- Push-in termination of solid conductors
- Termination/removal of fine-stranded conductors via push-buttons
- 45° conductor entry angle provides easy, space-saving wiring
- Custom color combinations
- Terminal strips also available with spacers upon request

Data

Electrical data

Ratings per IEC/EN

Ratings per	IEC/EN 60664-1
Nominal voltage (III/3)	160 V
Rated surge voltage (III/3)	2.5 kV
Rated voltage (III/2)	160 V
Rated surge voltage (III/2)	2.5 kV

Subject to changes. Please also observe the further product documentation!

WAGO Kontakttechnik GmbH & Co. KG
 Hansastr. 27
 32423 Minden
 Phone: +49571 887-0 | Fax: +49571 887-169
 Email: info.de@wago.com | Web: www.wago.com

Do you have any questions about our products?
 We are always happy to take your call at +49 (571) 887-44222.



Nominal voltage (II/2)	320 V
Rated surge voltage (II/2)	2.5 kV
Rated current	4 A
Legend (ratings)	(III / 2) \triangleq Overvoltage category III / Pollution degree 2

Ratings per UL

Approvals per	UL 1059
Rated voltage UL (Use Group B)	300 V
Rated current UL (Use Group B)	5 A
Rated voltage UL (Use Group D)	300 V
Rated current UL (Use Group D)	5 A

Ratings per CSA

Approvals per	CSA
Rated voltage CSA (Use Group B)	300 V
Rated current CSA (Use Group B)	5 A
Rated voltage CSA (Use Group D)	300 V
Rated current CSA (Use Group D)	5 A

Connection data

Connection technology	Push-in CAGE CLAMP [®]
Actuation type	Push-button
Solid conductor	0.14 ... 0.5 mm ² / 24 ... 20 AWG
Fine-stranded conductor	0.2 ... 0.5 mm ² / 24 ... 20 AWG
Conductor diameter	0.4 ... 0.8 mm
Strip length	8.5 ... 9.5 mm / 0.33 ... 0.37 inch
Conductor connection direction to PCB	45°
Pole No.	24
Total number of connection points	24
Total number of potentials	24
Number of connection types	1
Number of levels	1

Physical data

Pin spacing	2.5 mm / 0.098 inch
Width	61.5 mm / 2.421 inch

Subject to changes. Please also observe the further product documentation!



Height	16.7 mm / 0.657 inch
Height from the surface	13.1 mm / 0.516 inch
Depth	12 mm / 0.472 inch
Solder pin length	3.6 mm
Solder pin dimensions	0.4 x 0.75 mm
Drilled hole diameter with tolerance	1 ^(+0.1) mm

PCB contact

PCB Contact	THT
Solder pin arrangement	over the entire terminal strip (staggered)
Number of solder pins per potential	1

Material data

Color	gray
Material group	I
Insulation material	Polyamide (PA66)
Flammability class per UL94	V0
Clamping spring material	Copper alloy
Contact material	Electrolytic copper (E _{Cu})
Contact plating	tin-plated
Fire load	0.174 MJ
Weight	8.5 g

Environmental requirements

Limit temperature range	-60 ... +105 °C
-------------------------	-----------------

Commercial data



Product Group	4 (Printed Circuit)
Packaging type	BOX
Country of origin	CH
GTIN	4044918643382
Customs tariff number	85369010000

Approvals / Certificates



Country specific Approvals

Certificate

Subject to changes. Please also observe the further product documentation!

Logo	Approval	Additional Approval Text	name
	CCA DEKRA Certification B.V.	EN 60998	NTR NL-7449
	CCA DEKRA Certification B.V.	EN 60947	NTR NL-7100
	CSA DEKRA Certification B.V.	C22.2	1132097
	KEMA/KEUR DEKRA Certification B.V.	EN 60998	71-105258
	KEMA/KEUR DEKRA Certification B.V.	EN 60947	2160584.18
	VDE VDE Prüf- und Zertifizierungsinstitut	EN 60998	40028888

Ship Approvals

Logo	Approval	Additional Approval Text	Certificate name
	ABS American Bureau of Shipping	-	19-HG1869876-PDA
	DNV GL Det Norske Veritas, Germanischer Lloyd	-	TAE000016Z

UL-Approvals

Logo	Approval	Additional Approval Text	Certificate name
	UL UL International Germany GmbH	UL 1059	20180629-E45172

Subject to changes. Please also observe the further product documentation!



Compatible products

tools



Item no.: 210-647

Operating tool; Blade: 2.5 x 0.4 mm; with a partially insulated shaft; multicoloured

www.wago.com/210-647



Item no.: 210-719

Operating tool; Blade: 2.5 x 0.4 mm; with a partially insulated shaft

www.wago.com/210-719

Marking accessories

Item no.: 210-331/250-202

Marking strips; as a DIN A4 sheet; MARKED; 1-16 (400x); Height of marker strip: 2.3 mm/0.091 in; Strip length 182 mm; Horizontal marking; Self-adhesive; white

www.wago.com/210-331/250-202

Item no.: 210-331/250-204

Marking strips; as a DIN A4 sheet; MARKED; 17-32 (400x); Height of marker strip: 2.3 mm/0.091 in; Strip length 182 mm; Horizontal marking; Self-adhesive; white

www.wago.com/210-331/250-204

Item no.: 210-331/250-206

Marking strips; as a DIN A4 sheet; MARKED; 33-48 (400x); Height of marker strip: 2.3 mm/0.091 in; Strip length 182 mm; Horizontal marking; Self-adhesive; white

www.wago.com/210-331/250-206

Item no.: 210-331/250-207

Marking strips; as a DIN A4 sheet; MARKED; 1-48 (100x); Height of marker strip: 2.3 mm/0.091 in; Strip length 182 mm; Horizontal marking; Self-adhesive; white

www.wago.com/210-331/250-207

check



Item no.: 735-500

Test pin; 1 mm Ø; with solder connection for test wire

www.wago.com/735-500

Downloads

Documentation

Additional Information

Technical explanations

2019 Apr 3

pdf
2.0 MB

Download

CAD/CAE-Data

CAD data

2D/3D Models 250-424

URL

Download

Subject to changes. Please also observe the further product documentation!

WAGO Kontakttechnik GmbH & Co. KG

Hansastr. 27

32423 Minden

Phone: +49571 887-0 | Fax: +49571 887-169

Email: info.de@wago.com | Web: www.wago.com

Do you have any questions about our products?

We are always happy to take your call at +49 (571) 887-44222.



CAE data

EPLAN Data Portal 250-424	URL	Download
ZUKEN Portal 250-424	URL	Download

PCB Design

Symbol and Footprint 250-424	URL	Download
------------------------------	---------------------	--------------------------

CAX data for your PCB design, consisting of "schematic symbols and PCB footprints", allow easy integration of the WAGO component into your development environment.

Supported formats:

- Accel EDA 14 & 15
- Altium 6 to current version
- Cadence Allegro
- DesignSpark
- Eagle Libraries
- KiCad
- Mentor Graphics BoardStation
- Mentor Graphics Design Architect
- Mentor Graphics Design Expedition 99 and 2000
- OrCAD 9.X PCB and Capture
- PADS PowerPCB 3, 3.5, 4.X, and 5.X
- PADS PowerPCB and PowerLogic 3.0
- PCAD 2000, 2001, 2002, 2004, and 2006
- Pulsonix 8.5 or newer
- STL
- 3D STEP
- TARGET 3001!
- View Logic ViewDraw
- Quadcept
- Zuken CadStar 3 and 4
- Zuken CR-5000 and CR-8000

PCB Component Libraries (EDA), PCB CAD Library Ultra Librarian

Subject to changes. Please also observe the further product documentation!

Environmental Product Compliance

Compliance Search

Environmental Product Compliance 250-424

[URL](#)

[Download](#)

PCB terminal block; push-button; 0,5 mm²; Pin spacing 2.5 mm; 24-pole; Push-in
CAGE CLAMP®; 0,50 mm²; gray

Installation Notes

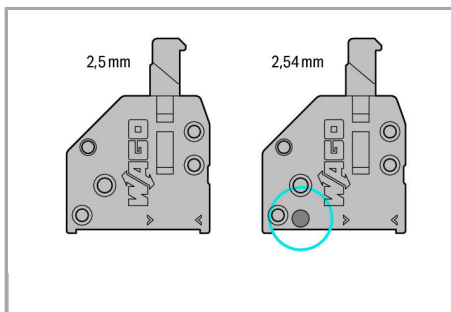

A groove at the back of the terminal strip differentiates between the two pin spacings.

Conductor termination

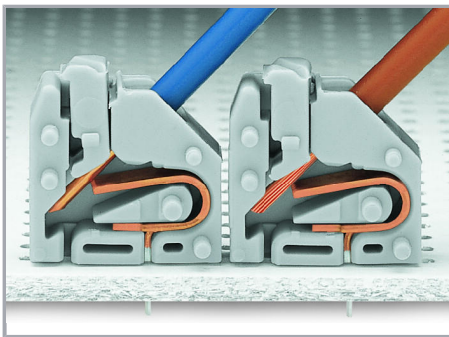

Inserting solid conductors via push-in termination.

Inserting fine-stranded conductors via push-buttons, 250 Series – 3.5 mm pin spacing.

Conductor termination

Subject to changes. Please also observe the further product documentation!

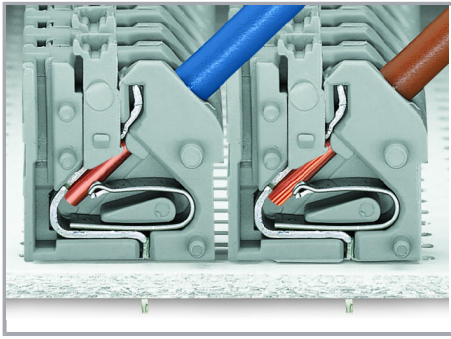

Space-saving wiring, 250 Series – 5 mm pin spacing.

Testing

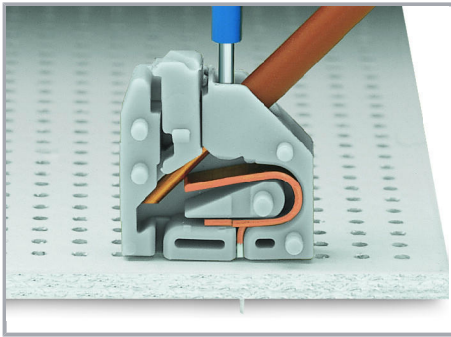

Testing with 11 mm Ø test pin, on the conductor, 250 Series – 2.5 ... 3.5 mm pin spacing.

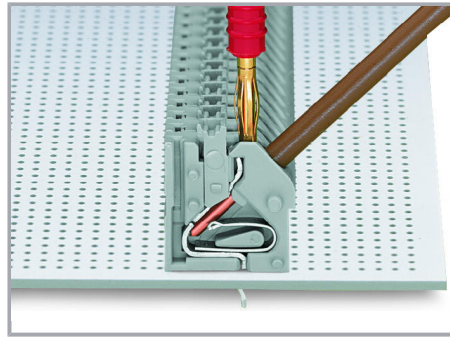

Testing with 2 mm Ø test plug, touch contact, 250 Series – 5 mm pin spacing.

Marking

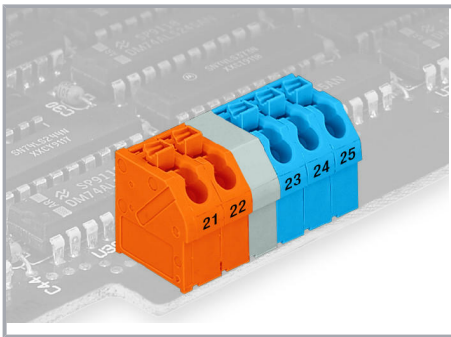

Labeling via self-adhesive strips or direct marking. Mixed-color terminal strips (with or without spacer) are available upon request.

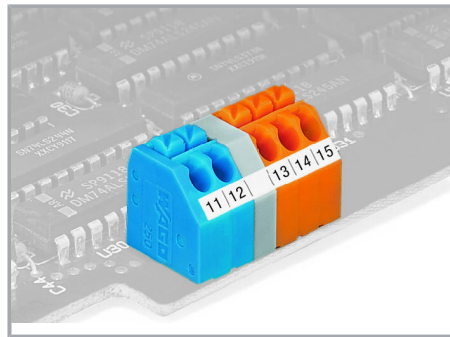

Labeling via self-adhesive strips or direct marking. Mixed-color terminal strips (with or without spacer) are available upon request.

Subject to changes. Please also observe the further product documentation!