

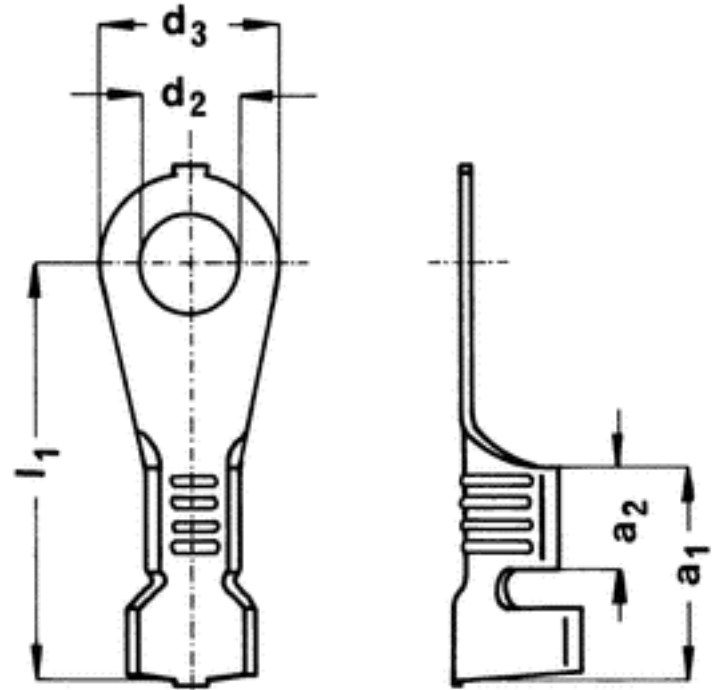

Characteristics and dimensions of terminals

Part number	25205.123.011
Specification	Claw terminal ring type
Material	CuZn
Surface / Colour	Sn 3
Form	Chain form
Transport	Longitudinal transport
Single part	X
Packing unit / piece	6000
Section area (mm ²)	0.50-1.00
DIN	46225 Form A
Nominal size	A5-1
Material thickness (mm)	0.60
a ₁	9.00
a ₂	4.50
d ₂	5.30
d ₃	9.50
l ₁	17.50



Note: The drawing only gives an overview of the geometry of the part. The crimp area is shown as supplied in strip form. A technical drawing is available on request.

[Contents of your inquiry](#)

Packing Units (per 6000 pieces)

CW