



Buchanan

TE Internal #: 282841-8

PCB Terminal Blocks, Header, Wire-to-Board, 8 Position, .2 in [5.08 mm] Centerline, 1 Row, Side Wire Entry Angle, 30 – 12 AWG Wire Size

[View on TE.com >](#)

Connectors > Terminal Blocks & Strips > PCB Terminal Blocks

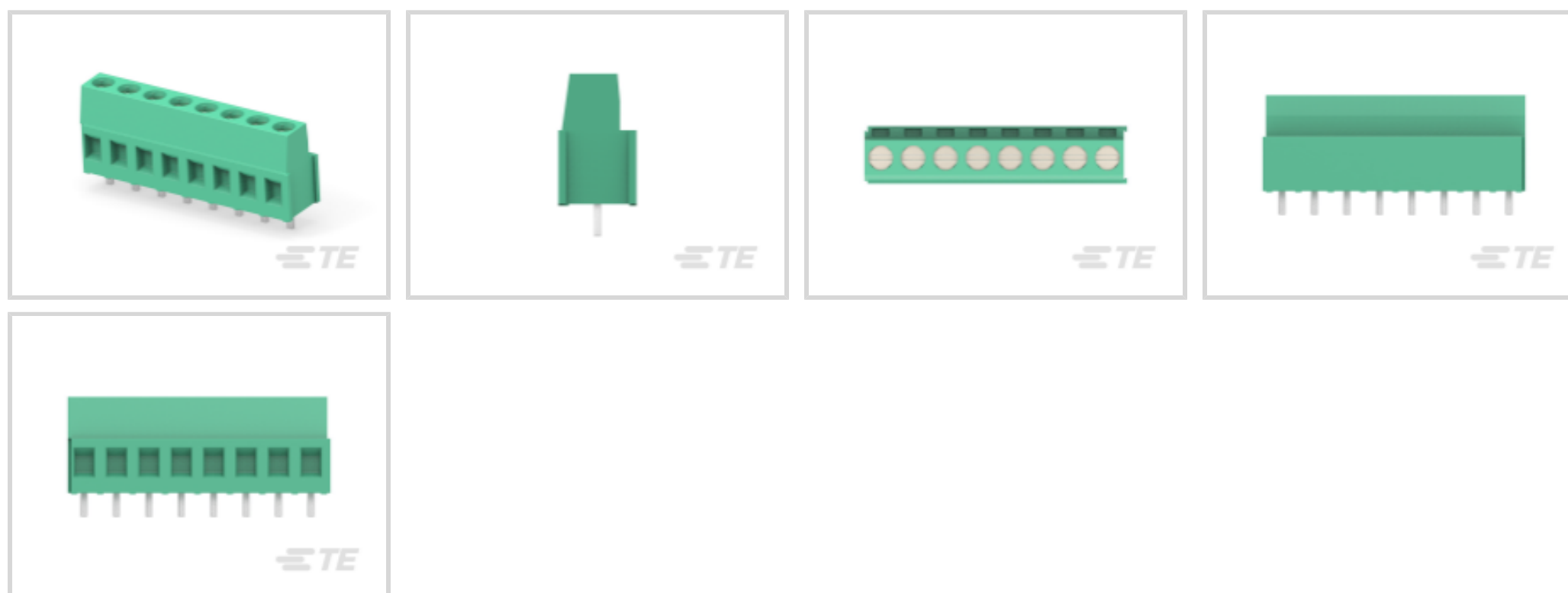

Terminal Block Connector Type: **Header**

Connector System: **Wire-to-Board**

Number of Positions: **8**

Centerline (Pitch): **5.08 mm [.2 in]**

Number of Rows: **1**

Features

Product Type Features

Wire Protection	With
Block Type	Stacking w/interlock
Terminal Block Connector Type	Header
Connector System	Wire-to-Board
Connector & Contact Terminates To	Printed Circuit Board

Configuration Features

Threaded Flange	Without
Stacked Levels	Without
Closed End	Without
Number of Positions	8
Number of Rows	1
Wire Entry Angle	Side

Electrical Characteristics

Current Rating (Max)	17.5 A
----------------------	--------



Voltage Rating	300 VAC
----------------	---------

Body Features

Interlock	With
-----------	------

Contact Features

Contact Mating Area Plating Material	Tin
--------------------------------------	-----

Contact Mount	Through Hole
---------------	--------------

Contact Base Material	Brass
-----------------------	-------

Contact Current Rating (Max)	17.5 A
------------------------------	--------

Mechanical Attachment

Screwless Terminal Block	No
--------------------------	----

Mounting Angle	Straight
----------------	----------

Screw Size	M3
------------	----

Screw Plating Material	Nickel
------------------------	--------

Screw Material	Brass
----------------	-------

Screw Flange	Without
--------------	---------

Connector Mounting Type	Board Mount
-------------------------	-------------

Housing Features

Housing Color	Green
---------------	-------

Housing Material	PA 66
------------------	-------

Centerline (Pitch)	5.08 mm [.2 in]
--------------------	-----------------

Dimensions

PCB Tail Length	3.5 mm [.138 in]
-----------------	------------------

Wire Size	.05 – 3 mm ²
-----------	-------------------------

Usage Conditions

Operating Temperature Range	-40 – 110 °C [-40 – 230 °F]
-----------------------------	-----------------------------

Operation/Application

Circuit Application	Power & Signal
---------------------	----------------

Packaging Features

Packaging Quantity	100
--------------------	-----

Other

Comment	15A Field Wiring
---------	------------------



Product Compliance

[For compliance documentation, visit the product page on TE.com>](#)

EU RoHS Directive 2011/65/EU	Compliant with Exemptions
EU ELV Directive 2000/53/EC	Compliant with Exemptions
China RoHS 2 Directive MIIT Order No 32, 2016	Restricted Materials Above Threshold
EU REACH Regulation (EC) No. 1907/2006	<p>Current ECHA Candidate List: JUNE 2022 (224)</p> <p>Candidate List Declared Against: JUL 2021 (219)</p> <p>SVHC > Threshold: Pb (2% in Component)</p> <p>Article Safe Usage Statements: Do not eat, drink or smoke when using this product. Wash thoroughly after handling. Recycle if possible and dispose of the article by following all applicable governmental regulations relevant to your geographic location.</p>
Halogen Content	Not Yet Reviewed for halogen content
Solder Process Capability	Wave solder capable to 265°C

Product Compliance Disclaimer

This information is provided based on reasonable inquiry of our suppliers and represents our current actual knowledge based on the information they provided. This information is subject to change. The part numbers that TE has identified as EU RoHS compliant have a maximum concentration of 0.1% by weight in homogenous materials for lead, hexavalent chromium, mercury, PBB, PBDE, DBP, BBP, DEHP, DIBP, and 0.01% for cadmium, or qualify for an exemption to these limits as defined in the Annexes of Directive 2011/65/EU (RoHS2). Finished electrical and electronic equipment products will be CE marked as required by Directive 2011/65/EU. Components may not be CE marked. Additionally, the part numbers that TE has identified as EU ELV compliant have a maximum concentration of 0.1% by weight in homogenous materials for lead, hexavalent chromium, and mercury, and 0.01% for cadmium, or qualify for an exemption to these limits as defined in the Annexes of Directive 2000/53/EC (ELV). Regarding the REACH Regulation, the information TE provides on SVHC in articles for this part number is based on the latest European Chemicals Agency (ECHA) 'Guidance on requirements for substances in articles' posted at this URL: <https://echa.europa.eu/guidance-documents/guidance-on-reach>

Compatible Parts

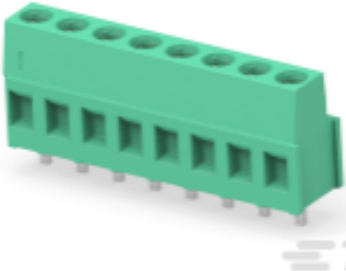
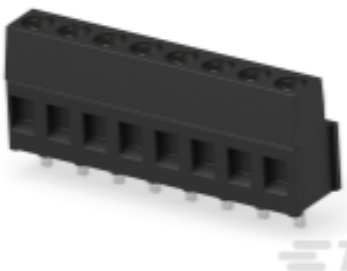
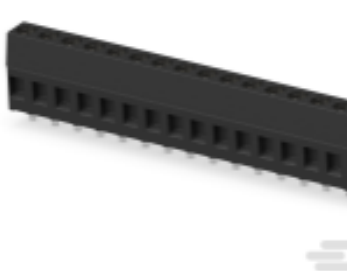
 <p>TE Part # 796683-8 TERMI-BLOK PCB MOUNT 90 8P.</p>	 <p>TE Part # 796949-8 8 POS TERMI-BLOK PCB MOUNT</p>	 <p>TE Part # 1-796949-6 16POS TERMI-BLOK PCB MOUNT</p>	 <p>TE Part # 2-796949-8 8 POS TERMI-BLOK W/INKSTAMP</p>
---	--	--	---

Customers Also Bought

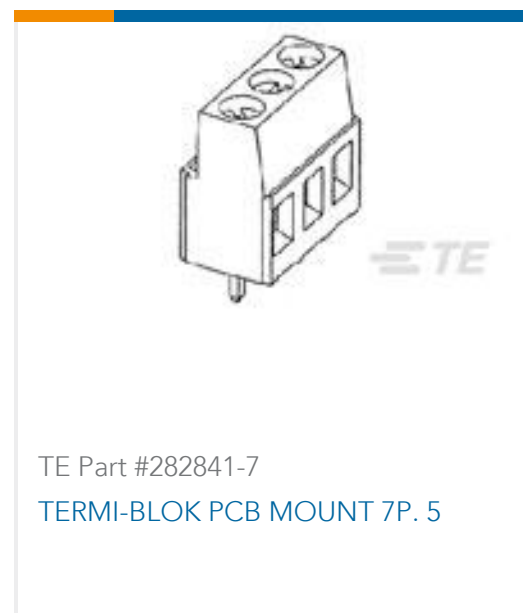
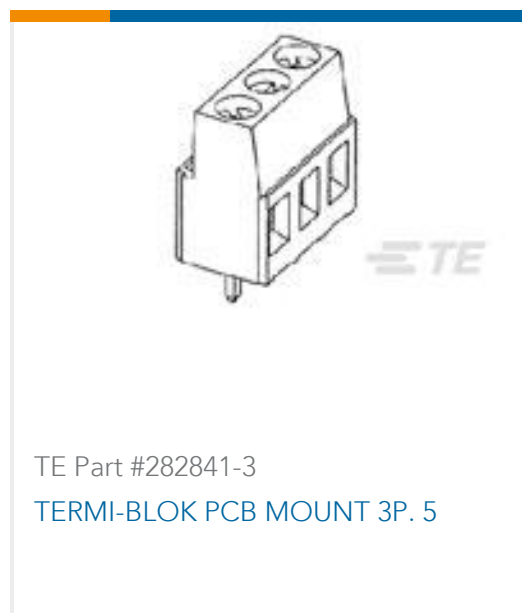
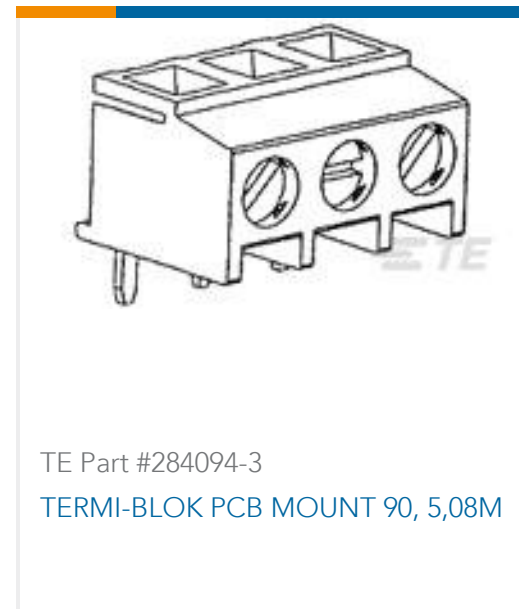
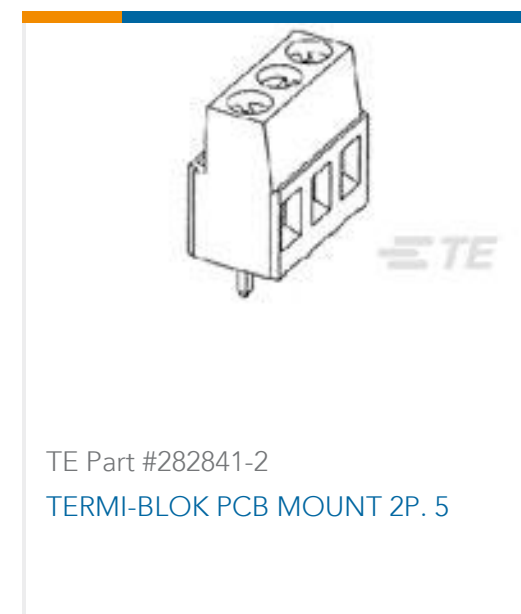
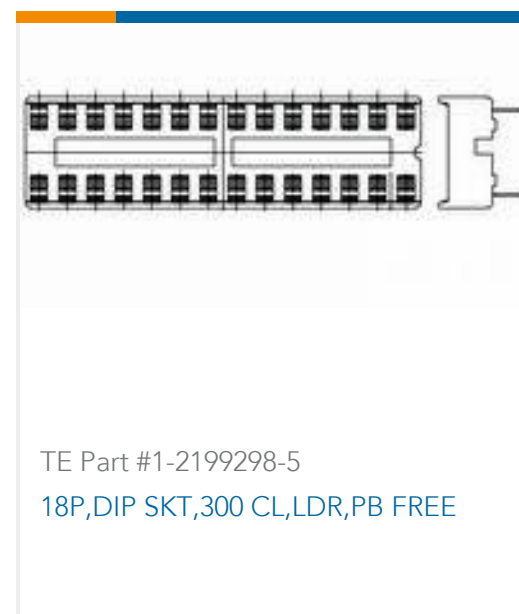

Documents

Product Drawings

[TERMI-BLOK PCB MOUNT 8P. 5](#)

English

CAD Files

Customer View Model

[ENG_CVM_282841-8_H4.3d_igs.zip](#)

English

3D PDF

3D

Customer View Model

[ENG_CVM_282841-8_H4.3d_stp.zip](#)

English

Customer View Model

[ENG_CVM_282841-8_H4.2d_dxf.zip](#)

English

3D PDF

3D



Customer View Model

[ENG_CVM_CVM_282841-8_C.2d_dxf.zip](#)

English

Customer View Model

[ENG_CVM_CVM_282841-8_C.3d_igs.zip](#)

English

Customer View Model

[ENG_CVM_CVM_282841-8_C.3d_stp.zip](#)

English

By downloading the CAD file I accept and agree to the [Terms and Conditions](#) of use.

Datasheets & Catalog Pages

[Eurostyle Terminal Blocks Focus Product Stock List](#)

English

[BUCHANAN TERMINAL BLOCKS CATALOG - EUROSTYLE TERMINAL BLOCKS](#)

English

[1-1773458-1_EURO_STYLE_TERMINAL_BLOCKS_ORG](#)

English

Product Specifications

[Application Specification](#)

English

Product Environmental Compliance

[TE Material Declaration](#)

English