

282180-1 ✓ ACTIVE

FASTIN-FASTON | FASTIN-FASTON 250

TE Internal #: 282180-1

Quick Disconnects, Receptacle, 20 – 15 AWG Wire Size, .51 – 1.65 mm² Wire Size, Mating Tab Width .187 in [4.75 mm], Straight, Brass, FASTIN-FASTON 250

[View on TE.com >](#)



Terminals & Splices > Quick Disconnects

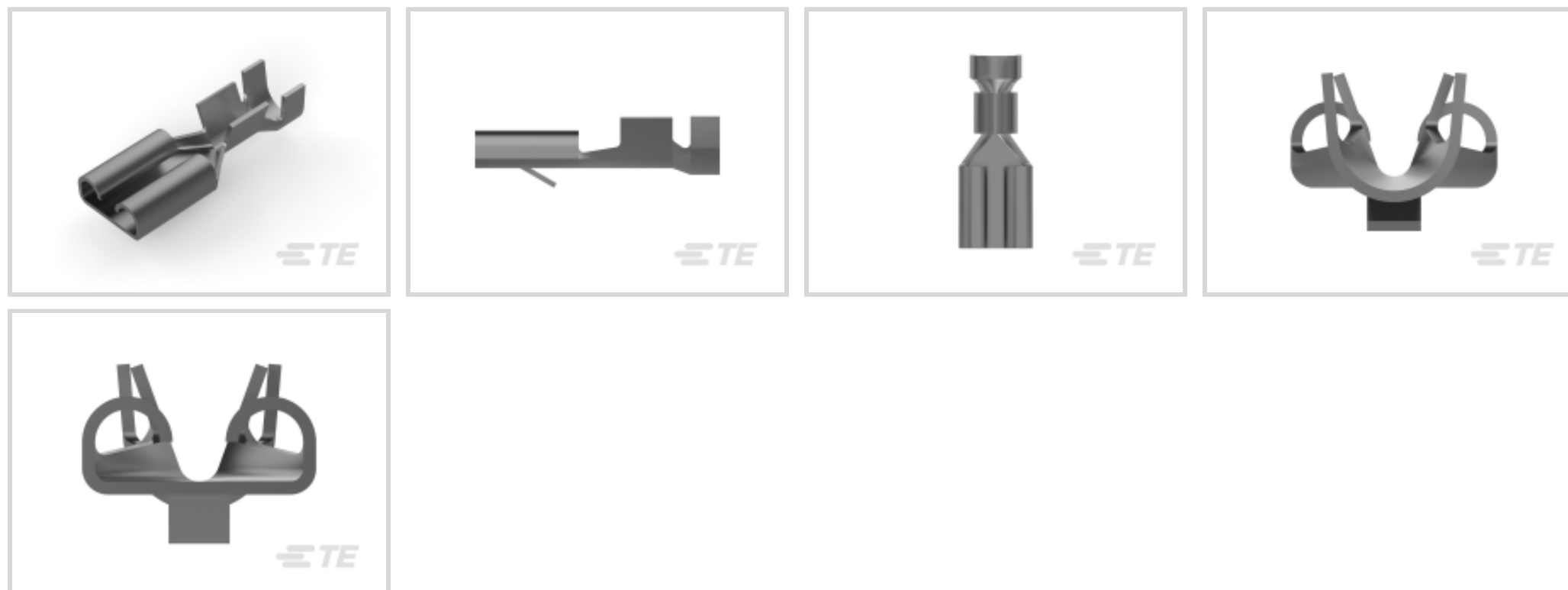

Quick Disconnect Terminal Type: **Receptacle**

Wire Size: .51 – 1.65 mm²

Mating Tab Width: 4.75 mm [.187 in]

Mating Tab Thickness: .81 mm [.032 in]

Features

Product Type Features

Terminates To	Wire & Cable
Wire Stop	No
Wire/Cable Type	Regular Wire
Insertion Force	Normal
Sealable	No

Configuration Features

Connection Capacity	Single
---------------------	--------

Electrical Characteristics

Voltage (Max)	250 V
---------------	-------

Contact Features

Quick Disconnect Terminal Type	Receptacle
Mating Tab Width	4.75 mm [.187 in]
Mating Tab Thickness	.81 mm [.032 in]
Terminal Orientation	Straight



Contact Base Material	Brass
Terminal Plating Material	Tin
Crimp Type	F-Crimp
Barrel Type	Open

Mechanical Attachment

Mating Retention Type	Locking Lance
Extraction Force	4 Newton
Wire Insulation Support	With

Dimensions

Accepts Wire Insulation Diameter Range	1.5 – 2.4 mm [.059 – .094 in]
Overall Length	16.6 mm [.653 in]
Receptacle Terminal Stock Thickness	.25 mm [.01 in]
Wire Size	.51 – 1.65 mm ²

Usage Conditions

Insulation Option	Uninsulated
Operating Temperature Range	-40 – 110 °C [-40 – 230 °F]

Packaging Features

Packaging Quantity	10000
Packaging Method	Strip/Reel

Product Compliance

[For compliance documentation, visit the product page on TE.com>](#)

EU RoHS Directive 2011/65/EU	Compliant
EU ELV Directive 2000/53/EC	Compliant
China RoHS 2 Directive MIIT Order No 32, 2016	No Restricted Materials Above Threshold
EU REACH Regulation (EC) No. 1907/2006	Current ECHA Candidate List: JUNE 2022 (224) Candidate List Declared Against: JAN 2022 (223) SVHC > Threshold: Not Yet Reviewed
Halogen Content	Low Halogen - Br, Cl, F, I < 900 ppm per homogenous material. Also BFR/CFR/PVC Free
Solder Process Capability	Not applicable for solder process capability

Product Compliance Disclaimer

This information is provided based on reasonable inquiry of our suppliers and represents our current actual knowledge based on the information they provided. This information is subject to change. The part numbers that TE has identified as EU RoHS compliant have a maximum concentration of 0.1% by weight in homogenous materials for lead, hexavalent chromium, mercury, PBB, PBDE, DBP, BBP, DEHP, DIBP, and 0.01% for cadmium, or qualify for an exemption to these limits as defined in the Annexes of Directive 2011/65/EU (RoHS2). Finished electrical and electronic equipment products will be CE marked as required by Directive 2011/65/EU. Components may not be CE marked. Additionally, the part numbers that TE has identified as EU ELV compliant have a maximum concentration of 0.1% by weight in homogenous materials for lead, hexavalent chromium, and mercury, and 0.01% for cadmium, or qualify for an exemption to these limits as defined in the Annexes of Directive 2000/53/EC (ELV). Regarding the REACH Regulation, the information TE provides on SVHC in articles for this part number is based on the latest European Chemicals Agency (ECHA) 'Guidance on requirements for substances in articles' posted at this URL: <https://echa.europa.eu/guidance-documents/guidance-on-reach>

Compatible Parts



TE Part # 2-2150303-1
OCEAN_2.0_Applicator-E-090F120F



TE Part # 2-2150303-2
OCEAN_2.0_Applicator-E-090F120F



TE Part # 2150303-1
OCEAN_2.0_Applicator-E-090F120F



TE Part # 2150303-2
OCEAN_2.0_Applicator-E-090F120F



TE Part # 7-2150303-1
OCEAN_2.0_Applicator-E-090F120F



TE Part # 7-2150303-2
OCEAN_2.0_Applicator-E-090F120F

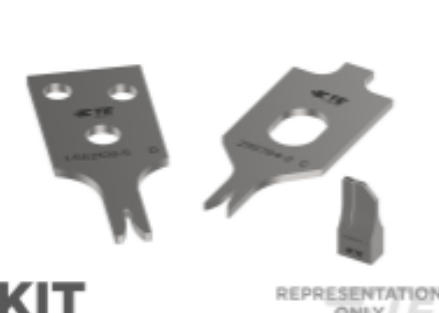

TE Part # 7-2150303-7
OCEAN_2.0_SPARE_PART_KIT-090F120F

Also in the Series | FASTIN-FASTON 250

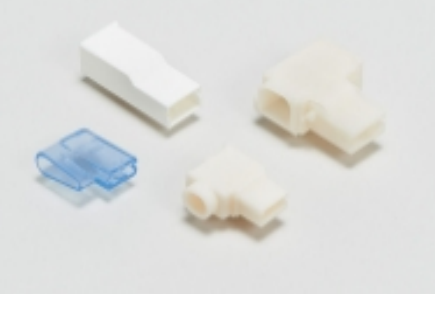

Crimp Terminal Housings(218)



Insertion & Extraction Tools(2)



PCB Terminals(2)



Quick Disconnects(255)

Customers Also Bought



TE Part #130094
PIDG RING



TE Part #1-965640-1
JUN-POW-TIM GEH 6P



TE Part #1-1703841-1
2POS,TAB 2.8X0.8,TAB HSG,ASSY,



TE Part #539635-1
ERGO HAND TOOL FRAME-NO DIES

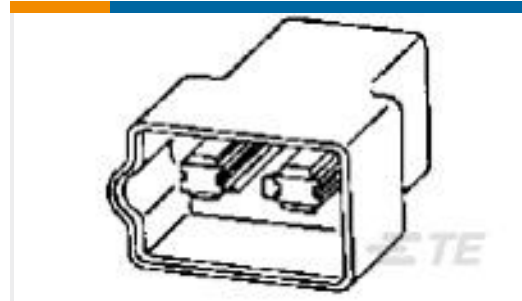

TE Part #180901
FF 250 TAB HSG 4P NYLON NAT



TE Part #454100-000
D-406-0002



TE Part #1-962842-1
TAB 2.8x0.8 CONTACT CS SRC Sn



TE Part #962825-2
FF 250 TAB 24-20 AWG .016 TPPB



TE Part #323152
DG 22-16COM 22-18MIL HR R 8



TE Part #927777-9
JUN-POW-TIM CONTACT

Documents

Product Drawings

[FF 187 REC 0.5-1.5MM2 TPBR](#)

English

CAD Files

Customer View Model

[ENG_CVM_CVM_282180-1_E.2d_dxf.zip](#)

English

3D PDF

3D

Customer View Model

[ENG_CVM_CVM_282180-1_E.3d_igs.zip](#)

English

Customer View Model

[ENG_CVM_CVM_282180-1_E.3d_stp.zip](#)

English

By downloading the CAD file I accept and agree to the [Terms and Conditions](#) of use.

Product Specifications



Application Specification

FASTIN-FASTON Connector, .187 rec. etc.