



[Dynamic Series](#) | [Dynamic 3000 Series](#)

TE Internal #: 2298107-3

Connector Contact, Receptacle, Component-to-Wire, 20 – 16 AWG

Wire Size, .5 – 1.42 mm<sup>2</sup> Wire Size, Gold, Reel & Box, Wire & Cable,

Dynamic 3000 Series

[View on TE.com >](#)

[Connectors >](#) [PCB Connectors >](#) [Wire-to-Board Connectors >](#) [Wire-to-Board Connector Contacts >](#)

Contact: Component To Wire; 15A, 28-14 wire size

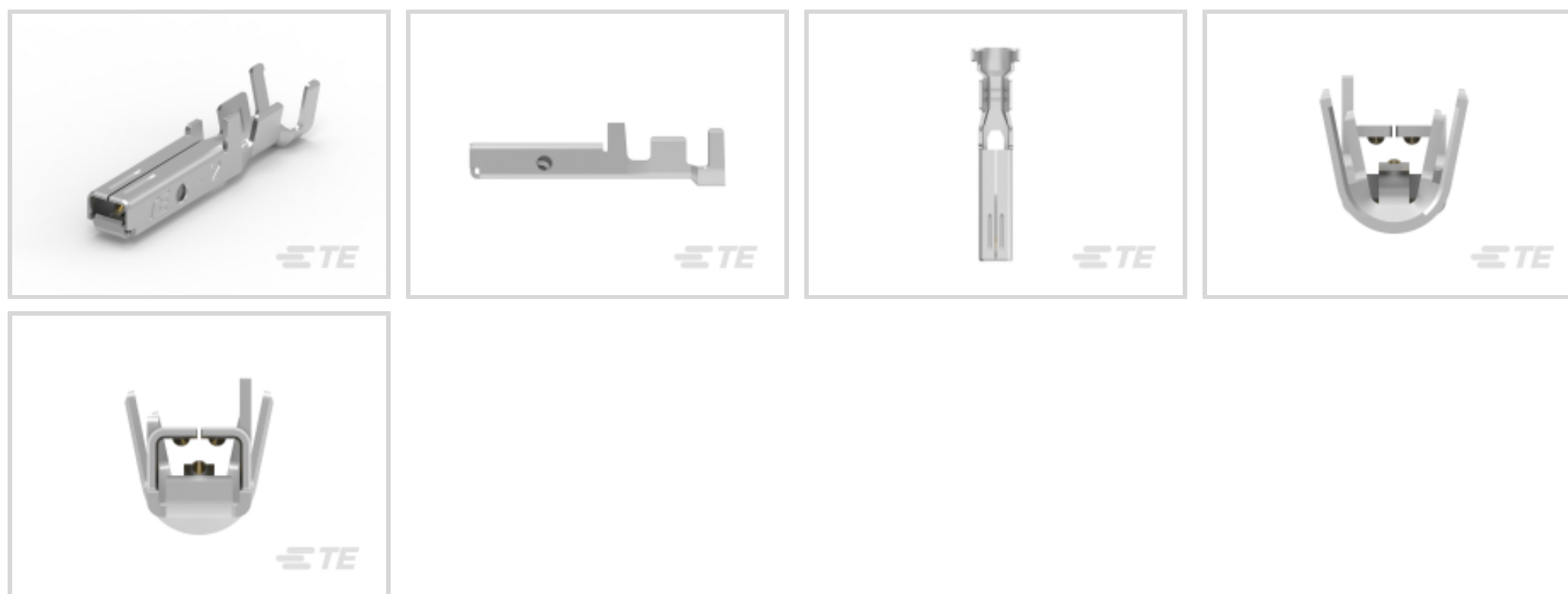

Contact Type: **Receptacle**

Connector System: **Component-to-Wire**

Wire Size: **.5 – 1.42 mm<sup>2</sup>**

Contact Mating Area Plating Material: **Gold**

[All Contact: Component To Wire; 15A, 28-14 wire size \(91\)](#)

## Features

### Product Type Features

Connector System	Component-to-Wire
Connector & Contact Terminates To	Wire & Cable

### Contact Features

Mating Tab Width	2 mm[.078 in]
Mating Tab Thickness	.64 mm[.025 in]
Contact Type	Receptacle
Contact Mating Area Plating Material	Gold
Contact Current Rating (Max)	15 A

### Dimensions

Wire Size	.5 – 1.42 mm <sup>2</sup>
-----------	---------------------------

### Usage Conditions

Operating Temperature Range	-55 – 105 °C[-67 – 221 °F]
-----------------------------	----------------------------



### Operation/Application

Circuit Application	Power & Signal
---------------------	----------------

### Packaging Features

Packaging Method	Reel & Box
------------------	------------

### Product Compliance

[For compliance documentation, visit the product page on TE.com>](#)

EU RoHS Directive 2011/65/EU	Compliant
EU ELV Directive 2000/53/EC	Compliant
China RoHS 2 Directive MIIT Order No 32, 2016	No Restricted Materials Above Threshold
EU REACH Regulation (EC) No. 1907/2006	Current ECHA Candidate List: JUNE 2022 (224) Candidate List Declared Against: JUNE 2022 (224) Does not contain REACH SVHC
Halogen Content	Low Halogen - Br, Cl, F, I < 900 ppm per homogenous material. Also BFR/CFR/PVC Free
Solder Process Capability	Not applicable for solder process capability

#### Product Compliance Disclaimer

This information is provided based on reasonable inquiry of our suppliers and represents our current actual knowledge based on the information they provided. This information is subject to change. The part numbers that TE has identified as EU RoHS compliant have a maximum concentration of 0.1% by weight in homogenous materials for lead, hexavalent chromium, mercury, PBB, PBDE, DBP, BBP, DEHP, DIBP, and 0.01% for cadmium, or qualify for an exemption to these limits as defined in the Annexes of Directive 2011/65/EU (RoHS2). Finished electrical and electronic equipment products will be CE marked as required by Directive 2011/65/EU. Components may not be CE marked. Additionally, the part numbers that TE has identified as EU ELV compliant have a maximum concentration of 0.1% by weight in homogenous materials for lead, hexavalent chromium, and mercury, and 0.01% for cadmium, or qualify for an exemption to these limits as defined in the Annexes of Directive 2000/53/EC (ELV). Regarding the REACH Regulation, the information TE provides on SVHC in articles for this part number is based on the latest European Chemicals Agency (ECHA) 'Guidance on requirements for substances in articles' posted at this URL: <https://echa.europa.eu/guidance-documents/guidance-on-reach>

### Compatible Parts



TE Part # 2-2151018-1  
[OCEAN\\_2.0\\_APPLICATOR-S-090F110F](#)



TE Part # 2151018-1  
[OCEAN\\_2.0\\_APPLICATOR-S-090F110F](#)



TE Part # 2-2151018-2  
[OCEAN\\_2.0\\_APPLICATOR-S-090F110F](#)



TE Part # 2151018-2  
[OCEAN\\_2.0\\_APPLICATOR-S-090F110F](#)



Also in the Series | **Dynamic 3000 Series**

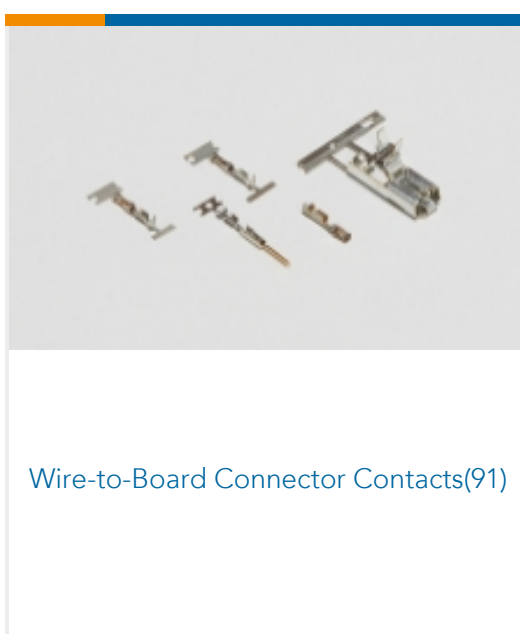
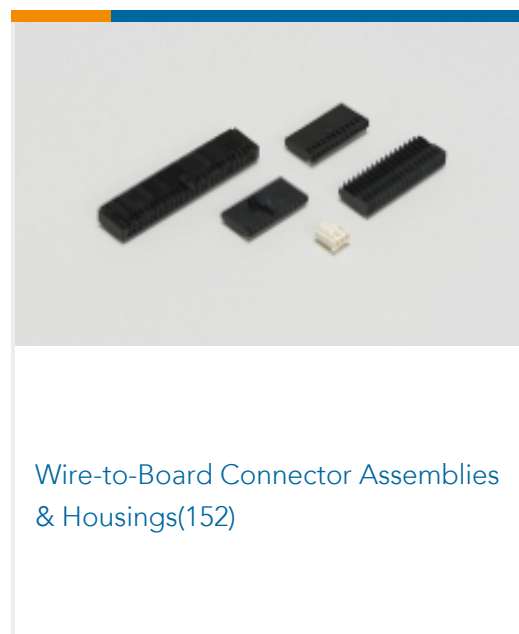
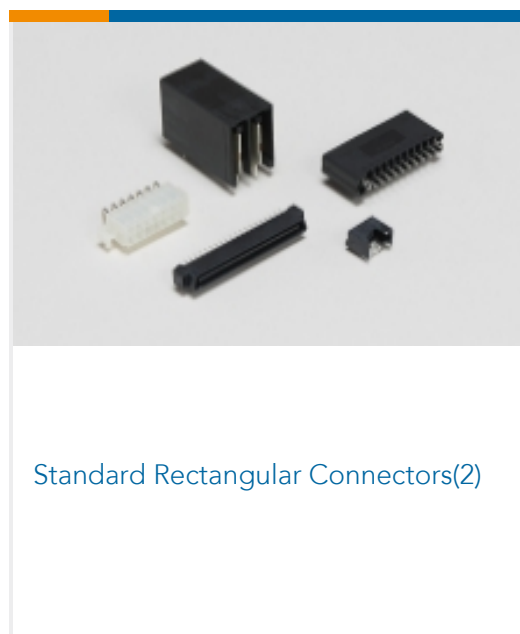
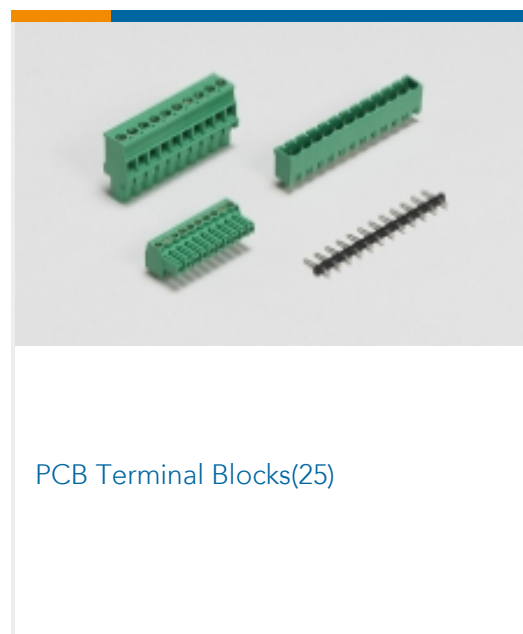
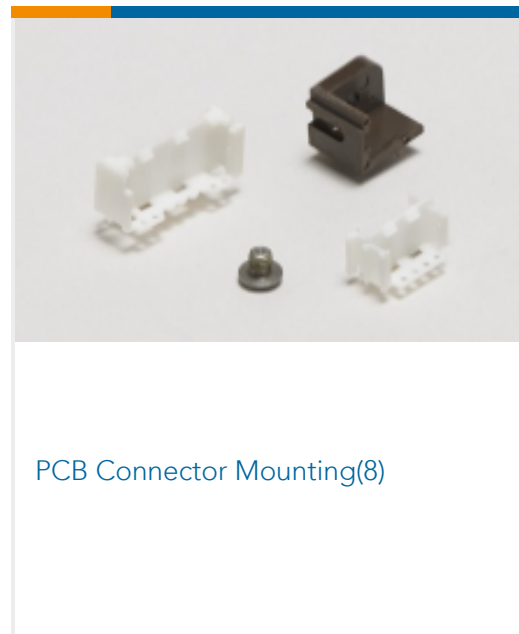
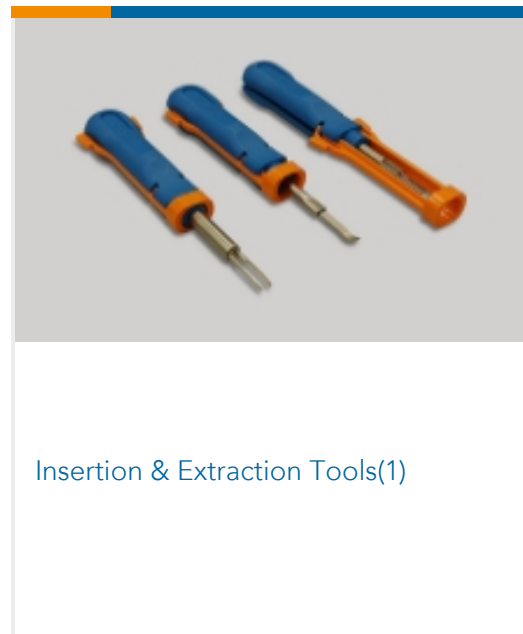
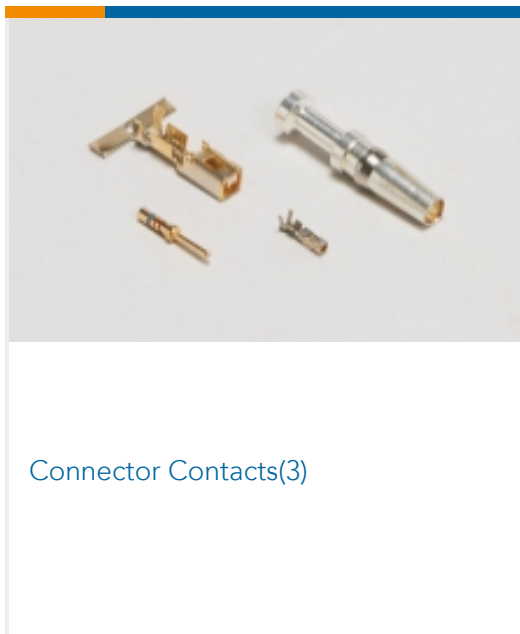

Customers Also Bought

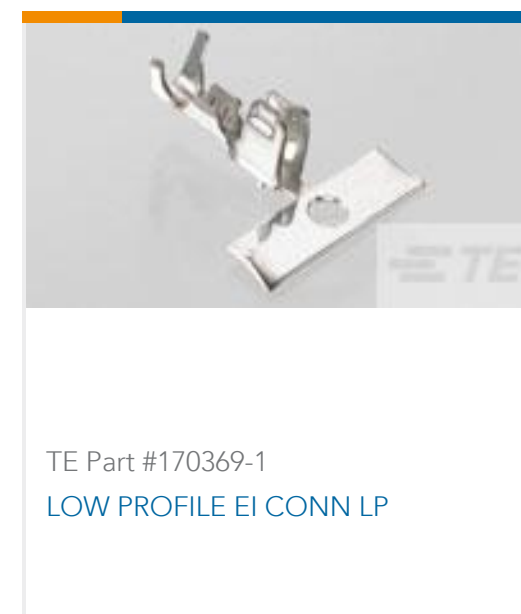

## Documents

### Product Drawings

[DYNAMIC D-3 FMLB REC CONT AU0.38 L SIZE](#)

Japanese

### CAD Files

[3D PDF](#)

3D

Customer View Model

[ENG\\_CVM\\_CVM\\_2298107-3\\_E.2d\\_dxf.zip](#)

English

Customer View Model

[ENG\\_CVM\\_CVM\\_2298107-3\\_E.3d\\_igs.zip](#)

English

Customer View Model

[ENG\\_CVM\\_CVM\\_2298107-3\\_E.3d\\_stp.zip](#)

English

By downloading the CAD file I accept and agree to the [Terms and Conditions](#) of use.

### Datasheets & Catalog Pages

[HDC Dynamic Connector](#)

[HDC Dynamic Connector](#)

Japanese

[HDC Dynamic Connector](#)

English

### Product Specifications

[Application Specification](#)



English

---

**Instruction Sheets**

**Instruction Sheet (U.S.)**

English

---

**Agency Approvals**

**TUV Certificate**

English