



DEUTSCH | DEUTSCH HD, DEUTSCH HDP

TE Internal #: 2428-015-1805

Automotive Connector Caps & Covers, Backshell, Cable Exit Angle 90° (Right Angle), Black, PA GF, Wire-to-Wire, 6 / 14 / 8 Position, DEUTSCH HDP

[View on TE.com >](#)

Connectors > Automotive Connectors > Connector Accessories > Connector Caps & Covers > DEUTSCH HDP20 BACKSHELLS



Protection & Strain Relief Accessory Type: **Backshell**

Cable Exit Angle: **90° (Right Angle)**

Strain Relief: **With**

Primary Product Color: **Black**

Primary Product Material: **PA GF**

[All DEUTSCH HDP20 BACKSHELLS \(12\)](#)

Features

Product Type Features

Protection & Strain Relief Accessory Type	Backshell
Connector System	Wire-to-Wire
Sealable	No
Connector & Contact Terminates To	Wire & Cable

Configuration Features

Number of Positions	6, 8, 14, 20, 21
---------------------	------------------

Body Features

Cable Exit Angle	90° (Right Angle)
Primary Product Color	Black
Primary Product Material	PA GF

Mechanical Attachment

Strain Relief	With
---------------	------

Dimensions

Compatible Cable Bundle Diameter Range	13 – 19 mm [.511 – .748 in]
--	-----------------------------

Usage Conditions

Compatible With Connector Style	Plug, Receptacle
Operating Temperature (Max)	125 °C [257 °F]
Operating Temperature Range	-55 – 125 °C [-67 – 257 °F]

Industry Standards

Degree of Protection	IP6K9K
UL Flammability Rating	UL 94HB

Packaging Features

Packaging Quantity	150
Packaging Method	Box

Other

Serviceable	Yes
-------------	-----

Product Compliance

[For compliance documentation, visit the product page on TE.com>](#)

EU RoHS Directive 2011/65/EU	Compliant
EU ELV Directive 2000/53/EC	Compliant
China RoHS 2 Directive MIIT Order No 32, 2016	No Restricted Materials Above Threshold
EU REACH Regulation (EC) No. 1907/2006	Current ECHA Candidate List: JUNE 2022 (224) Candidate List Declared Against: JAN 2022 (223) SVHC > Threshold: Not Yet Reviewed
Halogen Content	Low Halogen - Br, Cl, F, I < 900 ppm per homogenous material. Also BFR/CFR/PVC Free
Solder Process Capability	Not reviewed for solder process capability

Product Compliance Disclaimer

This information is provided based on reasonable inquiry of our suppliers and represents our current actual knowledge based on the information they provided. This information is subject to change. The part numbers that TE has identified as EU RoHS compliant have a maximum concentration of 0.1% by weight in homogenous materials for lead, hexavalent chromium, mercury, PBB, PBDE, DBP, BBP, DEHP, DIBP, and 0.01% for cadmium, or qualify for an exemption to these limits as defined in the Annexes of Directive 2011/65/EU (RoHS2). Finished electrical and electronic equipment products will be CE marked as required by Directive 2011/65/EU. Components may not be CE marked. Additionally, the part



numbers that TE has identified as EU ELV compliant have a maximum concentration of 0.1% by weight in homogenous materials for lead, hexavalent chromium, and mercury, and 0.01% for cadmium, or qualify for an exemption to these limits as defined in the Annexes of Directive 2000/53/EC (ELV). Regarding the REACH Regulation, the information TE provides on SVHC in articles for this part number is based on the latest European Chemicals Agency (ECHA) 'Guidance on requirements for substances in articles' posted at this URL: <https://echa.europa.eu/guidance-documents/guidance-on-reach>

Compatible Parts



TE Part # CAT-H396-CH8172
DEUTSCH HDP20 HOUSINGS



TE Part # HDP26-24-16PN-L017
PLG, 16P, BLK, N, RNG, 12, P

Also in the Series | DEUTSCH HD

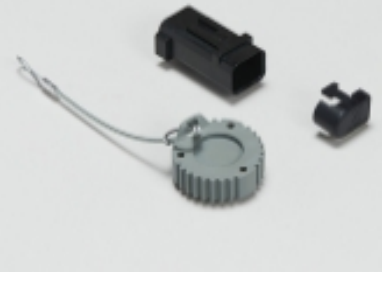

Automotive Connector Caps & Covers
(62)



Automotive Housings(742)



Automotive Seals & Cavity Plugs(10)



Insertion & Extraction Tools(11)



Other Automotive Connector
Accessories(11)



PCB Headers & Receptacles(1)

Also in the Series | DEUTSCH HDP

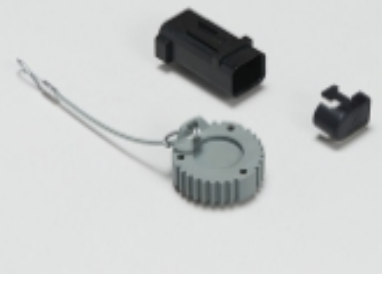

Automotive Connector Caps & Covers
(12)



Automotive Housings(331)



Automotive Seals & Cavity Plugs(1)



Insertion & Extraction Tools(11)

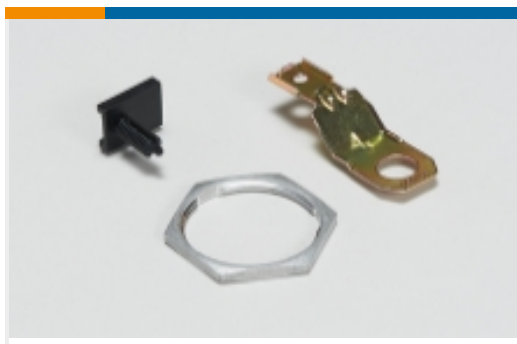

Other Automotive Connector Accessories(5)

Customers Also Bought

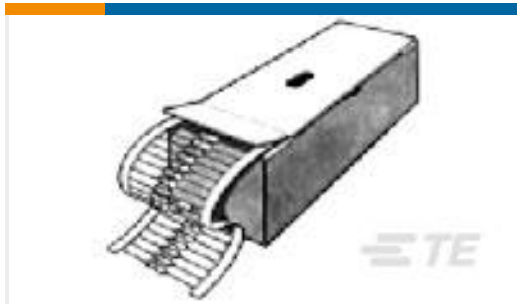
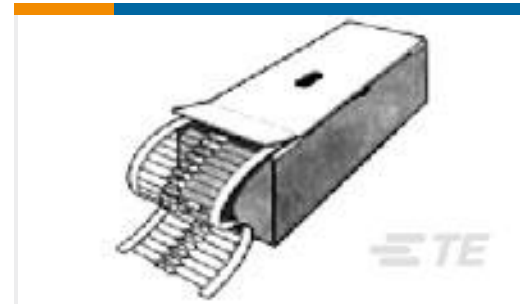
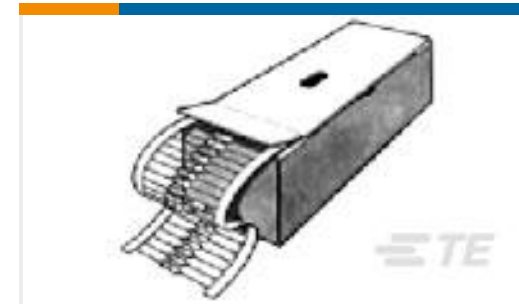
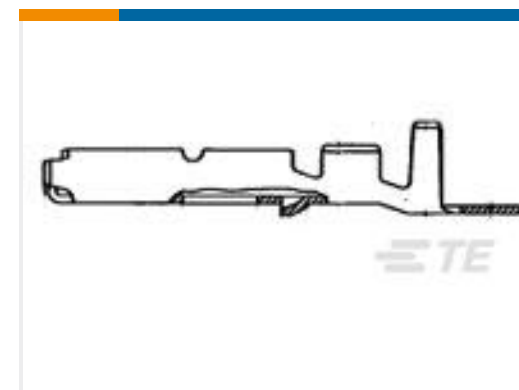
TE Part #1-1879927-2
EP 7W 330R 5%TE Part #2176080-9
EP 9W 220R 5%TE Part #1-2176080-1
EP 9W 470R 5%TE Part #HDP26-24-31PE-L017
DEUTSCH HDP20 HOUSINGSTE Part #2411-002-1805
PANEL NUT, SIZE 18, HDPTE Part #2428-010-2405
BKSHL, 24SZ, BLK, ST,NW17/19/26,
L017,HDPTE Part #172773-2
MIC MK-2 REC B TYPETE Part #DTV18P-BT-BK
BOOT, 18P, REC, ST, BLK

Documents

Product Drawings

BKSHL, 18SZ, BLK, RA,NW13/17/19,L017,HDP

English

CAD Files

3D PDF

3D

Customer View Model

[ENG_CVM_CVM_2428-015-1805_99_c-2428-015-1805-99.2d_dxf.zip](#)

English

Customer View Model

[ENG_CVM_CVM_2428-015-1805_99_c-2428-015-1805-99.3d_igs.zip](#)

English

Customer View Model

[ENG_CVM_CVM_2428-015-1805_99_c-2428-015-1805-99.3d_stp.zip](#)

English

By downloading the CAD file I accept and agree to the [Terms and Conditions](#) of use.



Datasheets & Catalog Pages

[ICT Terminals and Connectors Catalogue](#)

English

[CONNECTOR SELECTOR](#)

English

Product Specifications

[Application Specification](#)

English

Product Environmental Compliance

[Product Compliance](#)

English

[Product Compliance](#)

English