

282378-1 ✓ ACTIVE

AMP | Multilock .040

TE Internal #: 282378-1

Automotive Terminals, Tab, Mating Tab Width 1.7 mm [.07 in], Tab Thickness .025 in [.65 mm], 18 – 15 AWG Wire Size, Multilock .040

[View on TE.com >](#)



Terminals & Splices > Automotive Terminals



Terminal Type: **Tab**

Mating Tab Width: **1.7 mm [.07 in]**

Mating Tab Thickness: **.65 mm [.025 in]**

Terminal Transmits: **0 – 24 A (Low Power)**

Wire Size: **18 – 15 AWG**

Features

Product Type Features

Sealable	No
Primary Locking Feature	Clean Body

Contact Features

Contact Size	1.7mm
Contact Fabrication	Stamped & Formed
Typical Current Rating	14 A
Crimp Type	F-Crimp
Terminal Type	Tab
Mating Tab Width	1.7 mm[.07 in]
Mating Tab Thickness	.65 mm[.025 in]
Interface Plating	Tin (Sn)
Contact Termination Area Plating Material	Tin (Sn)

Termination Features

Termination Method to Wire & Cable	Crimp
------------------------------------	-------



Product Terminates To

Wire

Dimensions

Wire Size	.75 – 1.5 mm ²
Wire Size Search	15 AWG, 16 AWG, 17 AWG, 18 AWG
Tab Length	20.7 mm[.814 in]
Wire Insulation Diameter	1.9 – 2.6 mm[.074 – .1 in]

Usage Conditions

Insulation Option	Uninsulated
Operating Temperature (Max)	80 °C, 85 °C, 90 °C, 100 °C, 105 °C[176 °F][185 °F][194 °F][212 °F][221 °F]
Operating Temperature Range	-30 – 105 °C[-22 – 221 °F]

Packaging Features

Packaging Method	Reel
Packaging Quantity	4000

Other

Terminal Transmits	0 – 24 A (Low Power)
--------------------	----------------------

Product Compliance

[For compliance documentation, visit the product page on TE.com>](#)

EU RoHS Directive 2011/65/EU	Compliant
EU ELV Directive 2000/53/EC	Compliant
China RoHS 2 Directive MIIT Order No 32, 2016	No Restricted Materials Above Threshold
EU REACH Regulation (EC) No. 1907/2006	Current ECHA Candidate List: JUNE 2022 (224) Candidate List Declared Against: JAN 2022 (223) SVHC > Threshold: Not Yet Reviewed
Halogen Content	Low Halogen - Br, Cl, F, I < 900 ppm per homogenous material. Also BFR/CFR/PVC Free
Solder Process Capability	Not applicable for solder process capability

Product Compliance Disclaimer

This information is provided based on reasonable inquiry of our suppliers and represents our current actual knowledge based on the information they provided. This information is subject to change. The part numbers that TE has identified as EU RoHS compliant have a maximum concentration of 0.1% by weight in homogenous materials for lead, hexavalent

chromium, mercury, PBB, PBDE, DBP, BBP, DEHP, DIBP, and 0.01% for cadmium, or qualify for an exemption to these limits as defined in the Annexes of Directive 2011/65/EU (RoHS2). Finished electrical and electronic equipment products will be CE marked as required by Directive 2011/65/EU. Components may not be CE marked. Additionally, the part numbers that TE has identified as EU ELV compliant have a maximum concentration of 0.1% by weight in homogenous materials for lead, hexavalent chromium, and mercury, and 0.01% for cadmium, or qualify for an exemption to these limits as defined in the Annexes of Directive 2000/53/EC (ELV). Regarding the REACH Regulation, the information TE provides on SVHC in articles for this part number is based on the latest European Chemicals Agency (ECHA) 'Guidance on requirements for substances in articles' posted at this URL: <https://echa.europa.eu/guidance-documents/guidance-on-reach>

Compatible Parts



TE Part # 9-1579007-1
EXTRACTION TOOL



TE Part # CAT-M9194-CH8172
MULTILOCK, CONNECTOR HOUSING



TE Part # 2-2151887-1
OC-PA-S-FM-090F100F-001-0027



TE Part # 2-2151887-2
OC-PA-S-FA-090F100F-001-0027



TE Part # 2151887-1
OC-AT-S-FM-090F100F-001-0027



TE Part # 2151887-2
OC-AT-S-FA-090F100F-001-0027

Also in the Series | Multilock .040

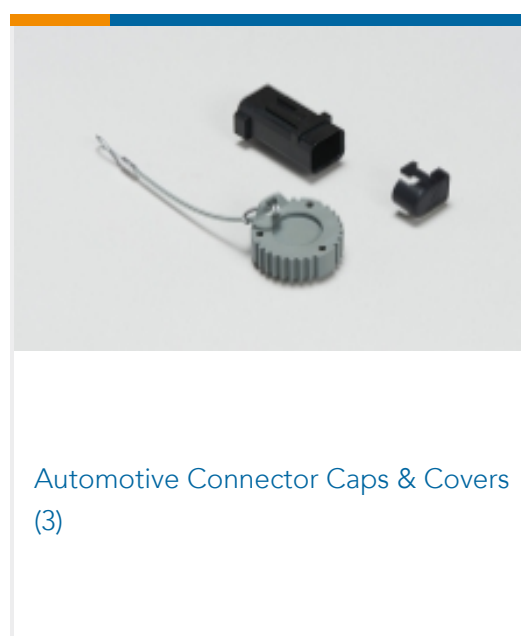

Automotive Connector Caps & Covers
(3)

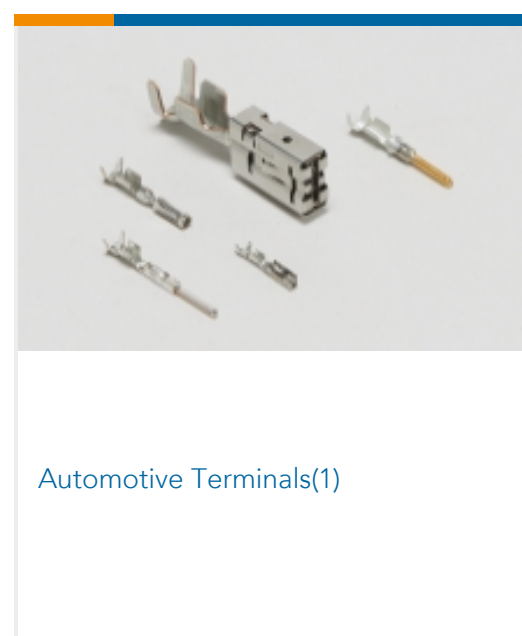

Automotive Terminals(1)

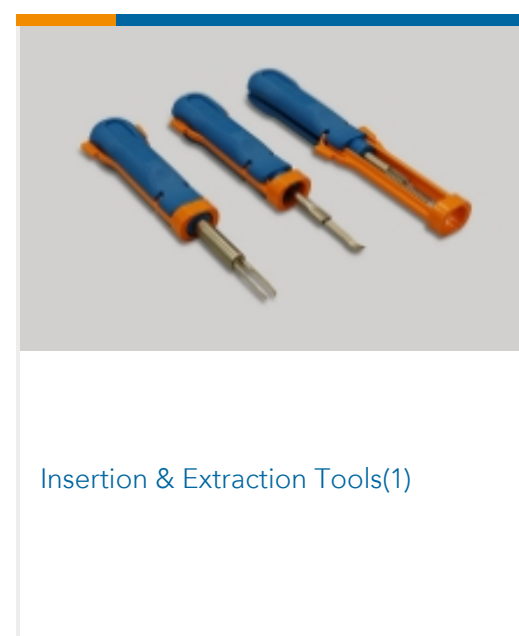

Insertion & Extraction Tools(1)

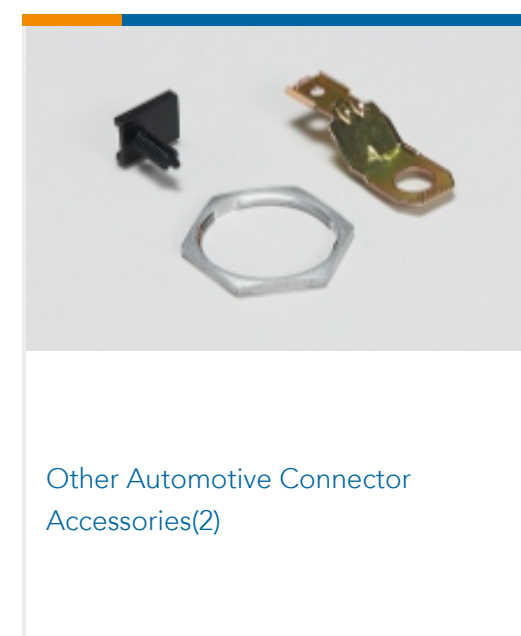

Other Automotive Connector
Accessories(2)

Customers Also Bought

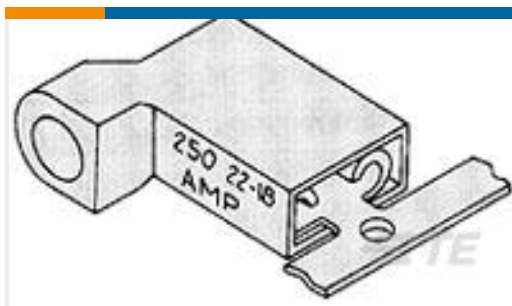

TE Part #2-520856-2
ULTRA-FAST 250 ASY REC 22-18 TPBR

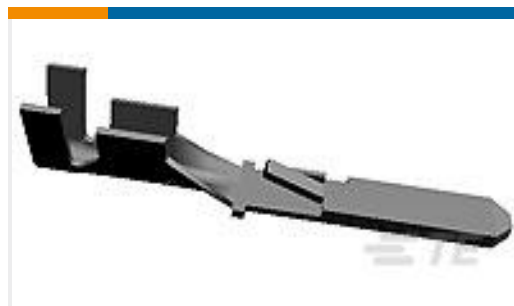

TE Part #160743-4
110 FASTIN FASTON,TAB,20-16 AWG,
PTBR



TE Part #7-1393163-6
MTMT00A0



TE Part #284848-3
12 POS MCP HYBRID FEMALE CONN

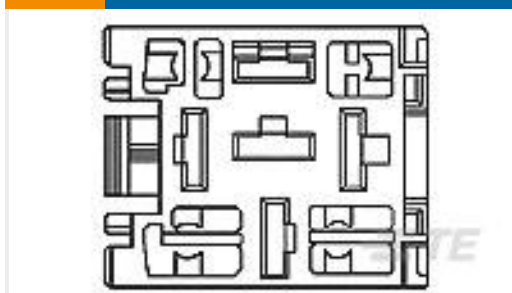

TE Part #280289
MODULAR RELAY CONN.



TE Part #284863-1
SINGLE WIRE SEAL F.EXT.INS.DIA

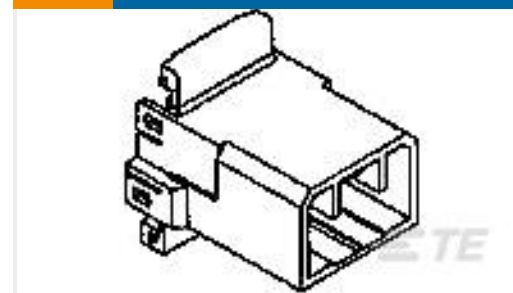

TE Part #174936-1
070 MLC W-W CAP HSG 20P

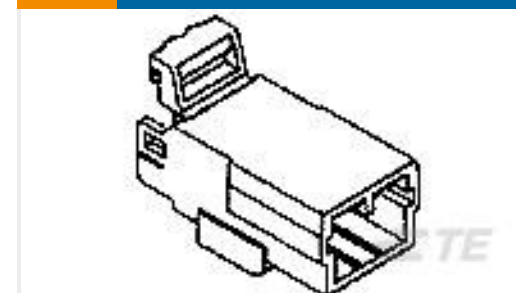

TE Part #174928-1
070 MLC W-W CAP HSG 3P NATURAL

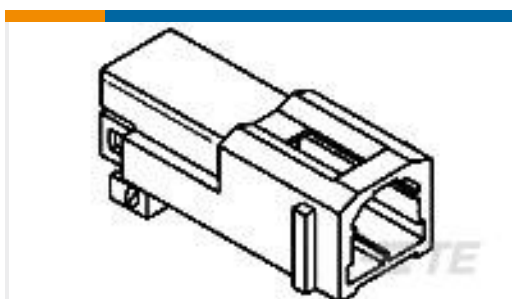

TE Part #174460-1
070 MULTILOCK 2P CAP HSG

Documents

Product Drawings

070 SERIES TAB CONTACT

English

CAD Files

3D PDF

3D

Customer View Model

[ENG_CVM_CVM_282378-1_C.2d_dxf.zip](#)

English

Customer View Model

[ENG_CVM_CVM_282378-1_C.3d_igs.zip](#)

English

Customer View Model

[ENG_CVM_CVM_282378-1_C.3d_stp.zip](#)

English

By downloading the CAD file I accept and agree to the [Terms and Conditions](#) of use.

Product Specifications



Application Specification

English

APPLICATION SPECIFICATION FOR 070 SR. MULTILOCK* TAB

English

Product Environmental Compliance

TE Material Declaration

English