

Component to wire connectors

DCS-1

2 & 3 way aggregate housings for 2.8 mm terminals

Features

- 2 and 3 position housings available
- Single row 5 mm pitch
- Flat interface seal
- Waterproof application with single wire seal
- Additional terminal locking device pre-assembled on front part of the housing
- Metal locking feature
- Mechanical polarization
- Several colour codings available

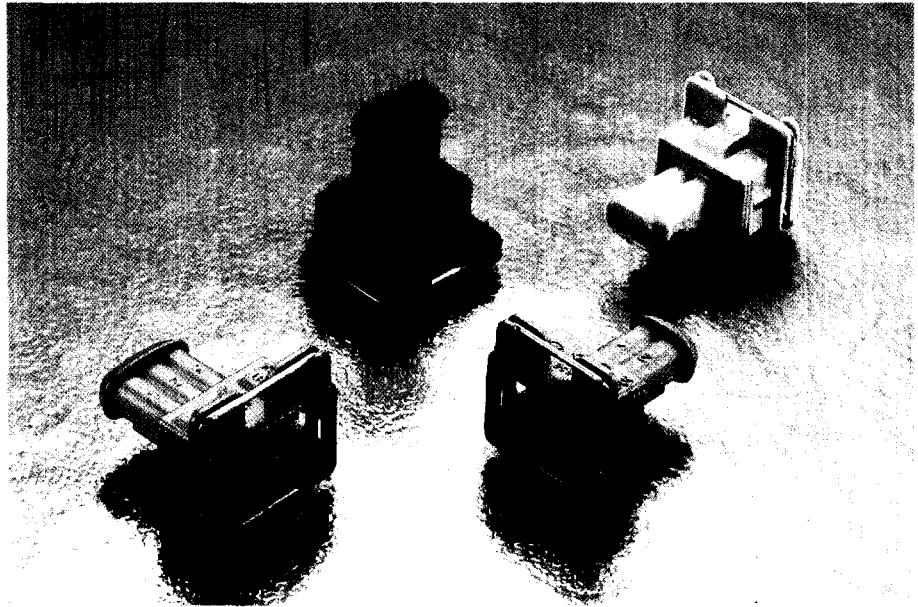

Part Numbers	No. of position	Terminal size	Type	Colour
240 PC02S9001	2	2.8 mm	Female housing	White
240 PC02S1001	2	2.8 mm	Female housing	Brown
240 PC02S2001	2	2.8 mm	Female housing	Red
240 PC02S5001	2	2.8 mm	Female housing	Green
240 PC02S6001	2	2.8 mm	Female housing	Blue
240 PC02S8001	2	2.8 mm	Female housing	Grey
240 PC02S4001	2	2.8 mm	Female housing	Yellow
240 PC03S0002	3	2.8 mm	Female housing	Black
240 PC03S1002	3	2.8 mm	Female housing	Brown
240 PC03S5002	3	2.8 mm	Female housing	Green
240 PC03S6002	3	2.8 mm	Female housing	Blue
240 PC03S8002	3	2.8 mm	Female housing	Grey
240 PC03S9002	3	2.8 mm	Female housing	White

Performance characteristics

- Temperature range :
from -40°C to +125°C
- Contact retention force : > 110 N
- Contact insertion force : < 20 N
- Sealing protection : IP 67
- Acceptable wire range :
from 0.35 to 1.5 mm²

Construction

- Housing material : PBT
- Flat interface seal : Silicone

Tooling

- T.P.A. removal tool : 65900000
- Terminal removal tool : 65900100

Connector compatibility

- Usable terminals :
 - DCS-1 2.8 mm female terminals (standard version)
 - DCS-1 2.8 mm female terminals (power version)

Component to wire connectors DCS-1

Dimensional characteristics

Codings

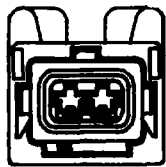

WHITE

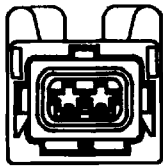

GREY

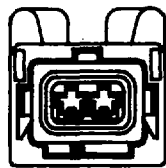

BLUE

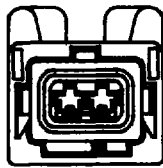

GREEN

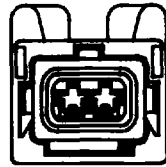

YELLOW

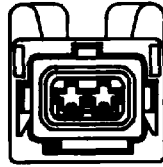

RED

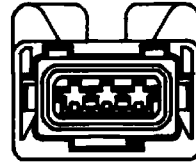
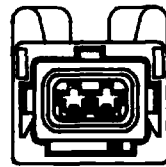

WHITE

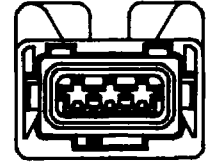

GREY

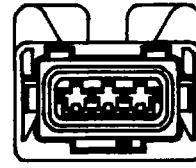

BLUE

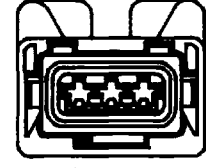

GREEN

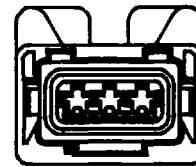

BROWN

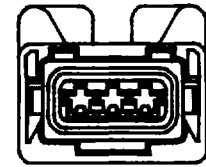

BLACK

2 way housing

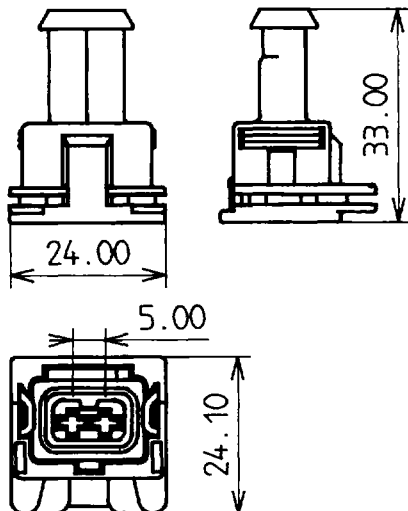

3 way housing

