

2232112-1 ✓ ACTIVE

FASTON | FASTON 250

TE Internal #: 2232112-1

Quick Disconnects, Receptacle, 18 – 14 AWG Wire Size, .82 – 2.08 mm² Wire Size, Mating Tab Width .25 in [6.35 mm], Straight, Brass, FASTON 250

[View on TE.com >](#)



Terminals & Splices > Quick Disconnects

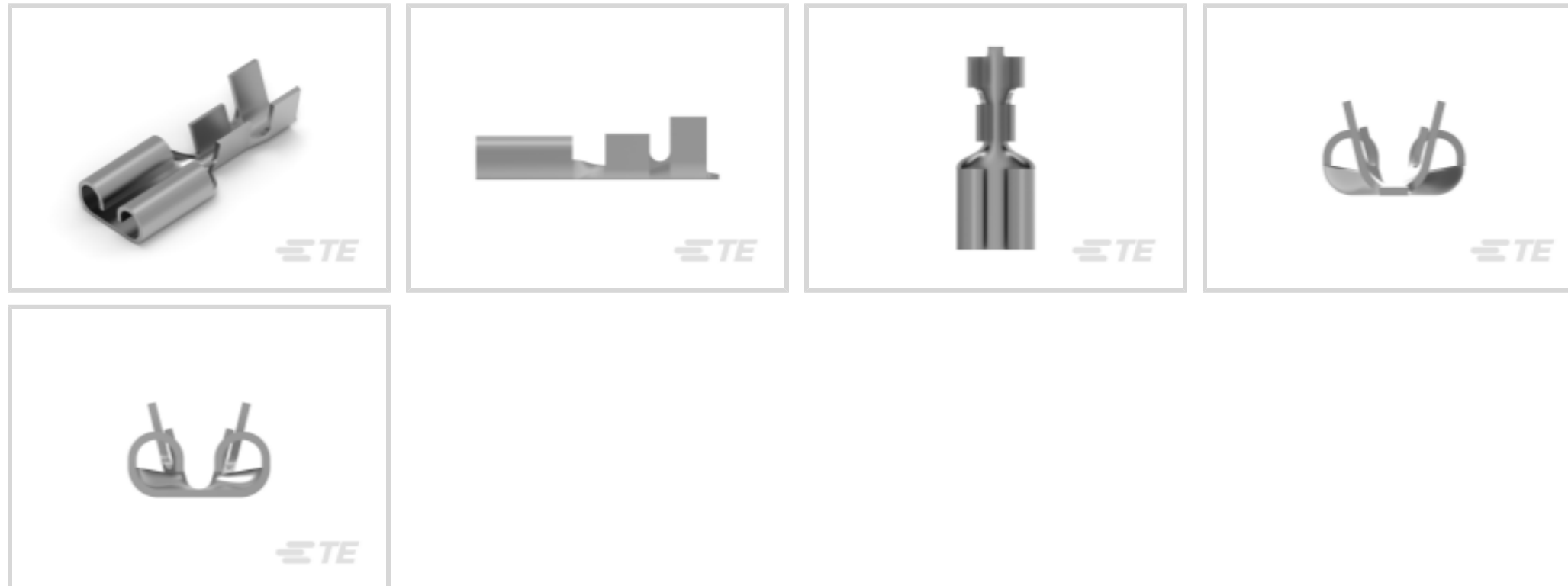

Quick Disconnect Terminal Type: **Receptacle**

Wire Size: **.82 – 2.08 mm²**

Mating Tab Width: **6.35 mm [.25 in]**

Mating Tab Thickness: **.81 mm [.032 in]**

Features

Product Type Features

Terminates To	Wire & Cable
Wire Stop	No
Wire/Cable Type	Regular Wire
Insertion Force	Normal
Sealable	No

Configuration Features

Connection Capacity	Single
---------------------	--------

Contact Features

Quick Disconnect Terminal Type	Receptacle
Mating Tab Width	6.35 mm[.25 in]
Mating Tab Thickness	.81 mm[.032 in]
Terminal Orientation	Straight
Contact Base Material	Brass
Terminal Plating Material	Tin
Crimp Type	F-Crimp



Barrel Type	Open
-------------	------

Mechanical Attachment

Mating Retention Type	Dimple
Wire Insulation Support	With

Dimensions

Accepts Wire Insulation Diameter Range	2.5 – 4.32 mm [.098 – .17 in]
Overall Length	18.9 mm [.744 in]
Receptacle Terminal Stock Thickness	.43 mm [.017 in]
Wire Size	.82 – 2.08 mm ²

Usage Conditions

Insulation Option	Uninsulated
Operating Temperature Range	-40 – 110 °C [-40 – 230 °F]

Industry Standards

UL Rating	Listed
CSA Certified	Yes

Packaging Features

Packaging Quantity	5000
Packaging Method	Strip/Reel

Product Compliance

[For compliance documentation, visit the product page on TE.com>](#)







EU RoHS Directive 2011/65/EU	Compliant
EU ELV Directive 2000/53/EC	Compliant
China RoHS 2 Directive MIIT Order No 32, 2016	No Restricted Materials Above Threshold
EU REACH Regulation (EC) No. 1907/2006	Current ECHA Candidate List: JUNE 2022 (224) Candidate List Declared Against: JAN 2022 (223) SVHC > Threshold: Not Yet Reviewed
Halogen Content	Low Halogen - Br, Cl, F, I < 900 ppm per homogenous material. Also BFR/CFR/PVC Free
Solder Process Capability	Not applicable for solder process capability

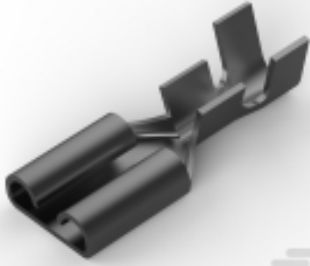

Product Compliance Disclaimer

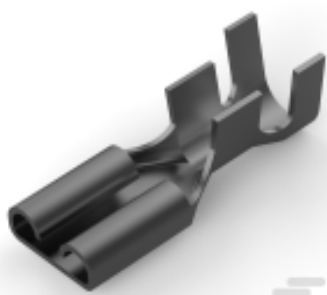
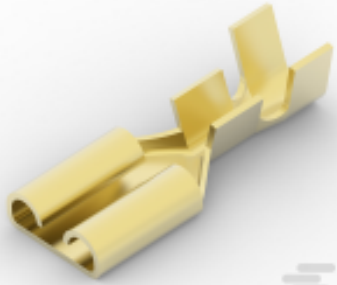
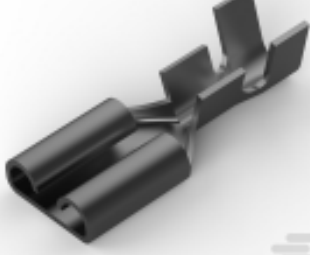
This information is provided based on reasonable inquiry of our suppliers and represents our current actual knowledge based on the information they provided. This information is subject to change. The part numbers that TE has identified as EU RoHS compliant have a maximum concentration of 0.1% by weight in homogenous materials for lead, hexavalent chromium, mercury, PBB, PBDE, DBP, BBP, DEHP, DIBP, and 0.01% for cadmium, or qualify for an exemption to these limits as defined in the Annexes of Directive 2011/65/EU (RoHS2). Finished electrical and electronic equipment products will be CE marked as required by Directive 2011/65/EU. Components may not be CE marked. Additionally, the part numbers that TE has identified as EU ELV compliant have a maximum concentration of 0.1% by weight in homogenous materials for lead, hexavalent chromium, and mercury, and 0.01% for cadmium, or qualify for an exemption to these limits as defined in the Annexes of Directive 2000/53/EC (ELV). Regarding the REACH Regulation, the information TE provides on SVHC in articles for this part number is based on the latest European Chemicals Agency (ECHA) 'Guidance on requirements for substances in articles' posted at this URL: <https://echa.europa.eu/guidance-documents/guidance-on-reach>

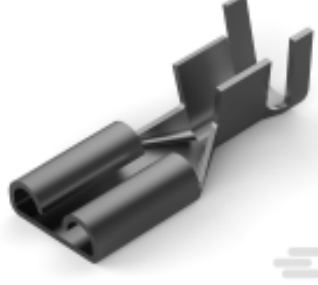
Compatible Parts

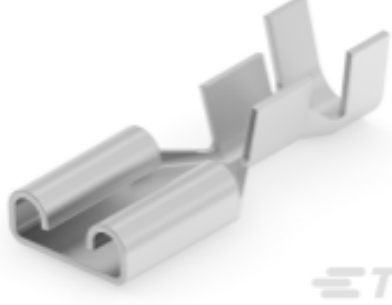
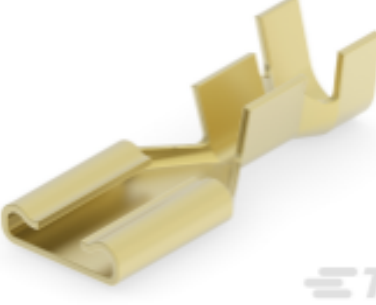
 <p>TE Part # 42400-2 250 FASTON REC 18-14 AWG TPBR</p>	 <p>TE Part # 170213-3 250 FASTON,REC.,18-14 AWG,TPPB</p>	 <p>TE Part # 42660-2 250 FASTON REC 18-14 AWG TPBR</p>	 <p>TE Part # 170224-2 250 FASTON,REC.,16-10 AWG,BR</p>
 <p>TE Part # 170213-1 250 FASTON,REC.,18-14 AWG,BR</p>	 <p>TE Part # 170213-2 250 FASTON,REC.,18-14 AWG,TPBR</p>	 <p>TE Part # 2232247-1 250 FASTON,REC.,16-10 AWG,BR</p>	 <p>TE Part # 63306-2 250 FASTON REC 18-14 AWG TPBR</p>
 <p>TE Part # 735211-2 250 FASTON REC 14-10 AWG TPBR</p>	 <p>TE Part # 170304-6 250 FASTON,REC.,22-18 AWG,BR</p>	 <p>TE Part # 60650-2 250 FASTON FLAG REC 18-14 AWG TPBR</p>	 <p>TE Part # 60713-1 FASTON 250 REC 18-14 AWG BR</p>

Also in the Series | **FASTON 250**



Compression Connectors(4)



Crimp Terminal Housings(143)



Insertion & Extraction Tools(6)



Magnet Wire Terminals(1)



PCB Terminals(144)



Quick Disconnects(456)



Splices(4)

Customers Also Bought

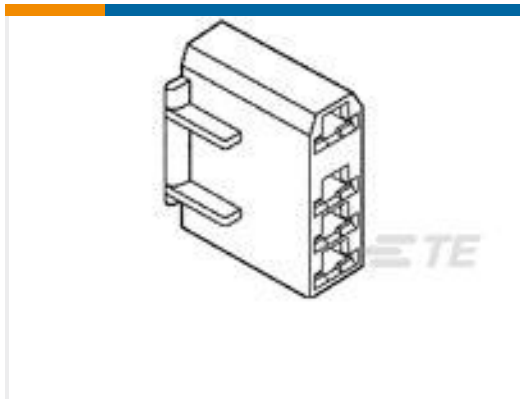

TE Part #520987-1
250 FASTON HSG. REC. 4P BLACK



TE Part #5-177898-1
Glow Wire Power Double Lock Plug



TE Part #5-179463-1
POWER DBL LOCK CAP HSG F/H 2P (GWT)



TE Part #1217039-1
TIMER CONNECTOR GEN 3 18-14 POST-TPBR



TE Part #5-179464-1
POWER DBL LOCK CAP HSG F/H 3P (GWT)



TE Part #2-1743068-1
187 HSG. PL MKII REC. 5mm 3P NAT



TE Part #2-1743216-1
GAS VALVE 2P HSG GWT



TE Part #2-1743217-1
GAS VALVE 3P HSG GWT

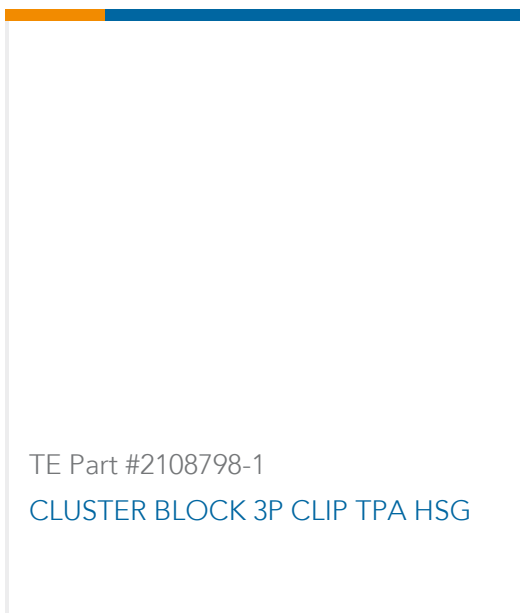

TE Part #2108798-1
CLUSTER BLOCK 3P CLIP TPA HSG

Documents



Product Drawings

[250 FASTON,REC.,18-14 AWG,TPBR](#)

English

CAD Files

[3D PDF](#)

3D

Customer View Model

[ENG_CVM_CVM_2232112-1_A1.2d_dxf.zip](#)

English

Customer View Model

[ENG_CVM_CVM_2232112-1_A1.3d_igs.zip](#)

English

Customer View Model

[ENG_CVM_CVM_2232112-1_A1.3d_stp.zip](#)

English

By downloading the CAD file I accept and agree to the [Terms and Conditions](#) of use.

Product Specifications

[Application Specification](#)

English

Product Environmental Compliance

[MD_2232112-1_11012017353_dmtec](#)

English

[MD_2232112-1_11012017353_dmtec](#)

English

Agency Approvals

[Agency Approval Document](#)

English