

2272975-1 ✓ ACTIVE

MCON Interconnection System

TE Internal #: 2272975-1

Housing for Female Terminals, Wire-to-Device / Wire-to-Board, 6 Position, .1 in [2.54 mm] Centerline, Sealable, Black, MCON Interconnection System

[View on TE.com >](#)



Connectors > Automotive Connectors > Connector Housings > MCON, CONNECTOR HOUSING

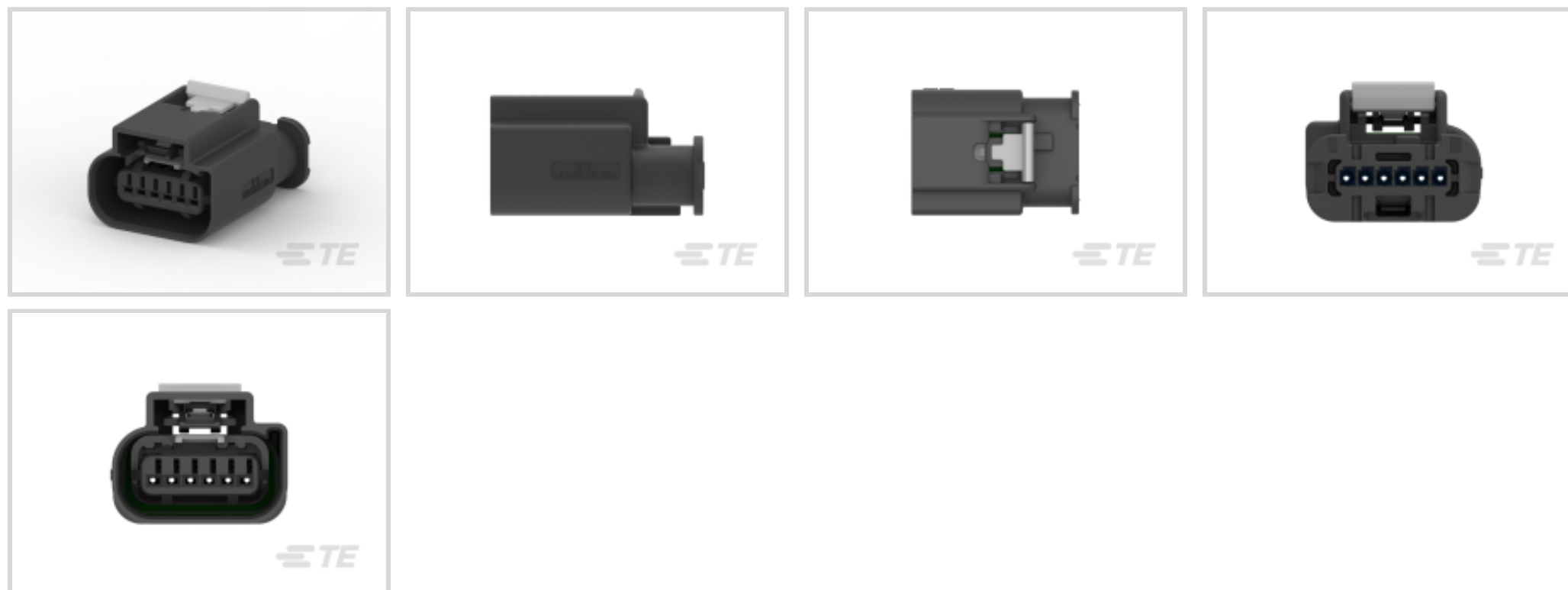

Connector & Housing Type: **Housing for Female Terminals**

Mating Tab Width: **1.2 mm [.047 in]**

Connector System: **Wire-to-Board, Wire-to-Device**

Number of Positions: **6**

Centerline (Pitch): **2.54 mm [.1 in]**

[All MCON, CONNECTOR HOUSING \(283\)](#)

Features

Product Type Features

Connector & Housing Shape	Rectangular
Connector & Housing Type	Housing for Female Terminals
Connector System	Wire-to-Board, Wire-to-Device
Sealable	Yes
Hybrid Connector	No
Primary Locking Feature	Integrated in Housing

Configuration Features

Number of Positions	6
Number of Rows	1

Body Features

Cable Exit Angle	90°
Body Material	PA GF



Primary Product Color	Black
-----------------------	-------

Connector Code	A
----------------	---

Contact Features

Contact Size	1.2mm
--------------	-------

Contact Type	Receptacle
--------------	------------

Mating Tab Width	1.2 mm[.047 in]
------------------	-----------------

Mechanical Attachment

Mounting Feature	Without
------------------	---------

Terminal Position Assurance	Yes
-----------------------------	-----

Strain Relief	Add By Accessory
---------------	------------------

Mating Alignment Type	Keyed
-----------------------	-------

Mating Alignment	With
------------------	------

Connector Mounting Type	Cable Mount (Free-Hanging)
-------------------------	----------------------------

Housing Features

Centerline (Pitch)	2.54 mm[.1 in]
--------------------	----------------

Dimensions

Product Width	18.3 mm[.72 in]
---------------	-----------------

Product Length	24.5 mm[.964 in]
----------------	------------------

Product Height	32.65 mm[1.285 in]
----------------	--------------------

Usage Conditions

Operating Temperature (Max)	70 °C, 75 °C, 80 °C, 85 °C, 90 °C, 100 °C, 105 °C, 110 °C, 120 °C, 125 °C, 130 °C, 140 °C, 145 °C, 150 °C[158 °F][167 °F][176 °F][185 °F][194 °F][212 °F][221 °F][230 °F][248 °F][257 °F][266 °F][284 °F][293 °F][302 °F]
-----------------------------	---

Operating Temperature Range	-40 – 150 °C[-40 – 302 °F]
-----------------------------	----------------------------

Operation/Application

Circuit Application	Signal
---------------------	--------

Industry Standards

Agency/Standard	GMW3191
-----------------	---------

Degree of Protection	IP67
----------------------	------

UL Flammability Rating	UL 94HB
------------------------	---------

Packaging Features



Packaging Method	Bag & Box
------------------	-----------

Other

Serviceable	Yes
Connector Position Assurance Capable	Yes

Product Compliance

[For compliance documentation, visit the product page on TE.com>](#)

EU RoHS Directive 2011/65/EU	Compliant
EU ELV Directive 2000/53/EC	Compliant
China RoHS 2 Directive MIIT Order No 32, 2016	No Restricted Materials Above Threshold
EU REACH Regulation (EC) No. 1907/2006	Current ECHA Candidate List: JUNE 2022 (224) Candidate List Declared Against: JAN 2022 (223) SVHC > Threshold: Not Yet Reviewed
Halogen Content	Low Halogen - Br, Cl, F, I < 900 ppm per homogenous material. Also BFR/CFR/PVC Free
Solder Process Capability	Not applicable for solder process capability

Product Compliance Disclaimer

This information is provided based on reasonable inquiry of our suppliers and represents our current actual knowledge based on the information they provided. This information is subject to change. The part numbers that TE has identified as EU RoHS compliant have a maximum concentration of 0.1% by weight in homogenous materials for lead, hexavalent chromium, mercury, PBB, PBDE, DBP, BBP, DEHP, DIBP, and 0.01% for cadmium, or qualify for an exemption to these limits as defined in the Annexes of Directive 2011/65/EU (RoHS2). Finished electrical and electronic equipment products will be CE marked as required by Directive 2011/65/EU. Components may not be CE marked. Additionally, the part numbers that TE has identified as EU ELV compliant have a maximum concentration of 0.1% by weight in homogenous materials for lead, hexavalent chromium, and mercury, and 0.01% for cadmium, or qualify for an exemption to these limits as defined in the Annexes of Directive 2000/53/EC (ELV). Regarding the REACH Regulation, the information TE provides on SVHC in articles for this part number is based on the latest European Chemicals Agency (ECHA) 'Guidance on requirements for substances in articles' posted at this URL: <https://echa.europa.eu/guidance-documents/guidance-on-reach>

Compatible Parts



TE Part # CAT-M4595-T273
MCON, RECEPTACLE AND TAB



TE Part # 2272976-1
Left/Right Wire Dress



TE Part # 2272976-2
Right Angle Wire Dress



TE Part # 2272976-3
Right Angle Wire Dress



TE Part # 2272976-4
Straight Wire Dress

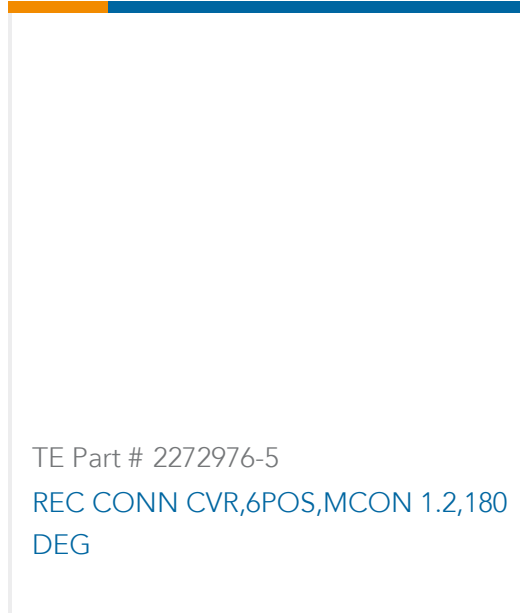

TE Part # 2272976-5
REC CONN CVR,6POS,MCON 1.2,180 DEG

Also in the Series | MCON Interconnection System

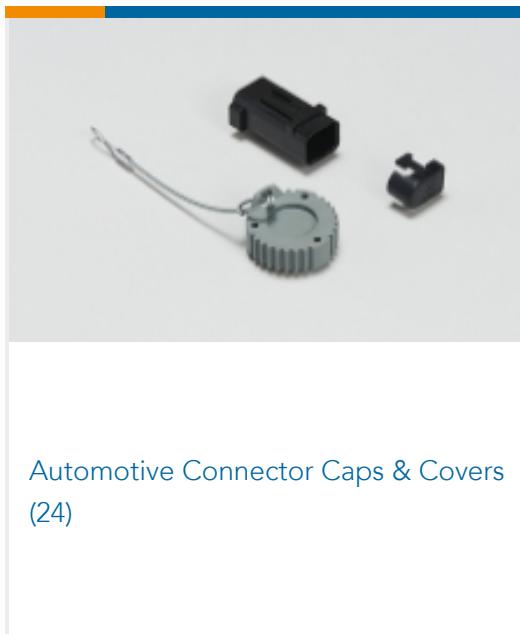

Automotive Connector Caps & Covers
(24)



Automotive Connector Locks &
Position Assurance(11)

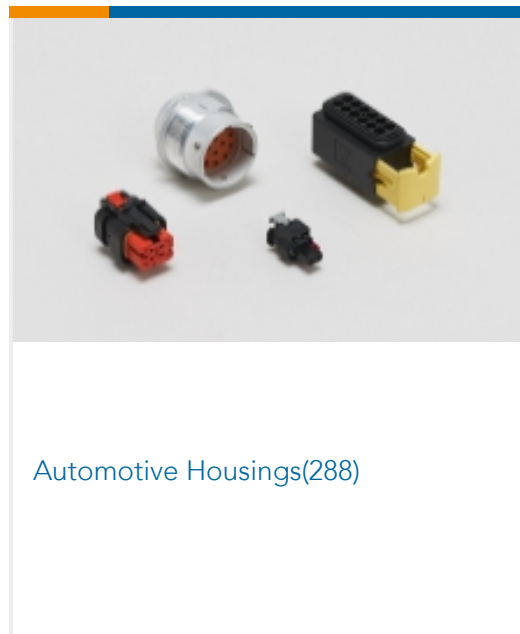

Automotive Housings(288)

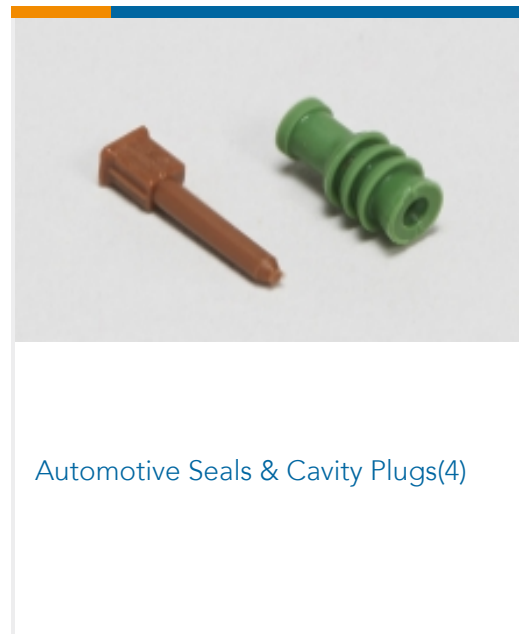

Automotive Seals & Cavity Plugs(4)

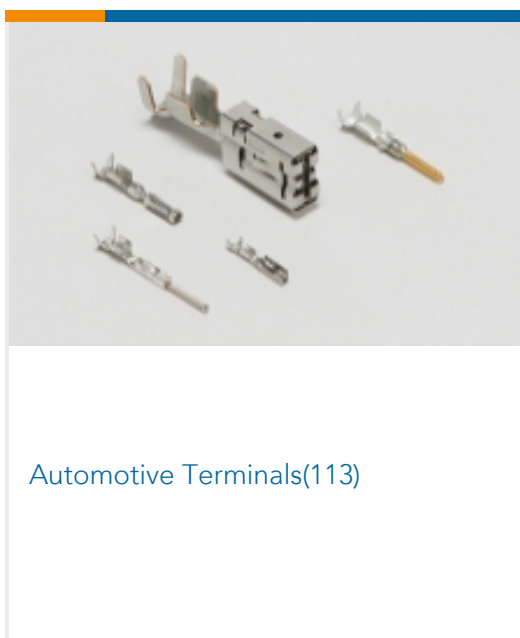

Automotive Terminals(113)

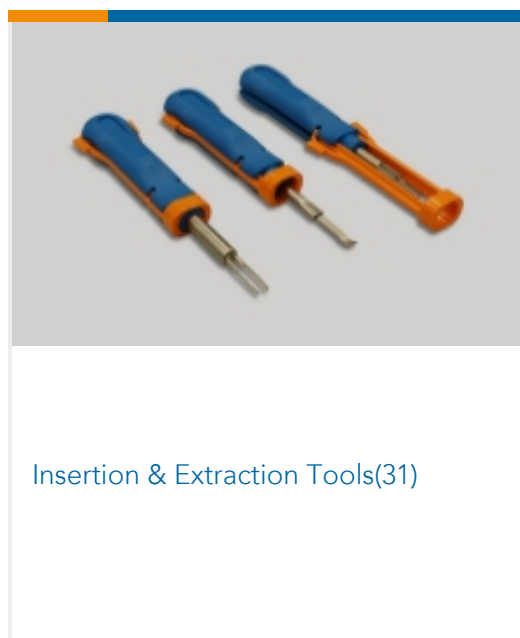

Insertion & Extraction Tools(31)

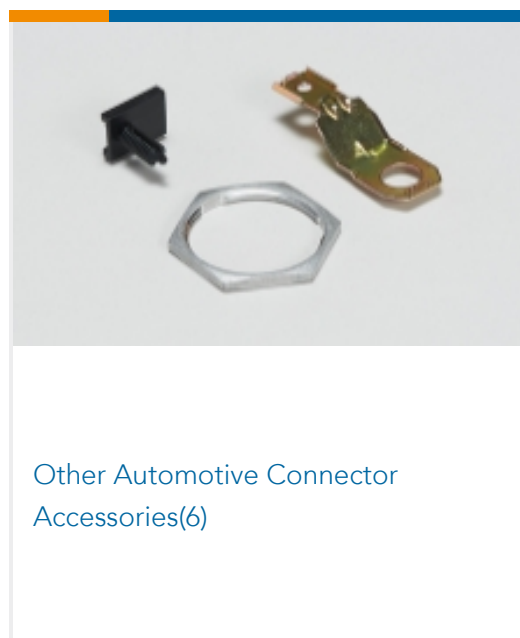

Other Automotive Connector
Accessories(6)



PCB Headers & Receptacles(1)

Customers Also Bought



TE Part #1-967239-1
JPT GEH KPL GEH 2P



TE Part #2098198-5
Plug Assembly, Sealed, 1 Posn,



TE Part #2141230-1
3POS,PIN DIA 8.0,PIN HSG,ASSY,SLD



TE Part #1827540-1
DYNAMIC D-2600 HYBRID REC HSG
48P



Documents

Product Drawings

6 Pos. Sealed MCON 1.2 Connect

English

CAD Files

3D PDF

3D

Customer View Model

[ENG_CVM_CVM_2272975-1_A.2d_dxf.zip](#)

English

Customer View Model

[ENG_CVM_CVM_2272975-1_A.3d_igs.zip](#)

English

Customer View Model

[ENG_CVM_CVM_2272975-1_A.3d_stp.zip](#)

English

By downloading the CAD file I accept and agree to the [Terms and Conditions](#) of use.

Datasheets & Catalog Pages

MCON Interconnection System

English

Instruction Sheets

Instruction Sheet (U.S.)

English