

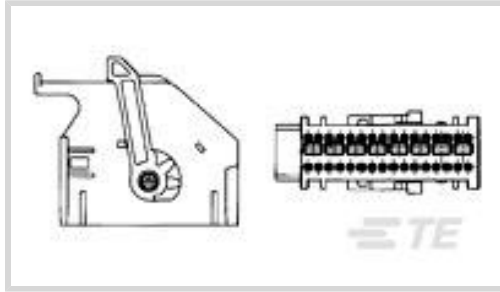

Connectors > Automotive Connectors > Connector Housings > MQS, CONNECTOR HOUSING



Connector & Housing Type: **Housing for Female Terminals**

Mating Tab Width: **.64 mm [.025 in]**

Connector System: **Wire-to-Wire**

Number of Positions: **32**

Centerline (Pitch): **2.54 mm [.1 in]**

[All MQS, CONNECTOR HOUSING \(557\)](#)

Features

Product Type Features

Connector & Housing Shape	Rectangular
Connector & Housing Type	Housing for Female Terminals
Connector System	Wire-to-Wire
Sealable	No
Hybrid Connector	No
Primary Locking Feature	On the Terminal

Configuration Features

Number of Positions	32
Number of Rows	2

Electrical Characteristics

Operating Voltage	24 VDC
Nominal Voltage Architecture	12 V, 24 V

Body Features

Cable Exit Angle	90°
Body Material	PA GF
Primary Product Color	White

Contact Features



Contact Size	.63mm
Contact Type	Receptacle
Mating Tab Width	.64 mm[.025 in]

Mechanical Attachment

Mounting Feature	Without
Terminal Position Assurance	No
Strain Relief	Without
Mating Alignment Type	Polarized
Mating Alignment	With
Connector Mounting Type	Cable Mount (Free-Hanging)

Housing Features

Centerline (Pitch)	2.54 mm[.1 in]
--------------------	----------------

Dimensions

Product Width	17.6 mm[.693 in]
Product Length	48.3 mm[1.902 in]
Product Height	39.9 mm[1.571 in]
Row-to-Row Spacing	5 mm[.197 in]

Usage Conditions

Operating Temperature (Max)	70 °C, 75 °C, 80 °C, 85 °C, 90 °C, 100 °C, 105 °C[158 °F][167 °F][176 °F][185 °F][194 °F][212 °F][221 °F]
Operating Temperature Range	-30 – 105 °C[-22 – 221 °F]

Operation/Application

Circuit Application	Signal
---------------------	--------

Packaging Features

Packaging Method	Box
------------------	-----

Other

Serviceable	No
Connector Position Assurance Capable	No

Product Compliance

[For compliance documentation, visit the product page on TE.com>](#)

EU RoHS Directive 2011/65/EU	Compliant
------------------------------	-----------



EU ELV Directive 2000/53/EC	Compliant
China RoHS 2 Directive MIIT Order No 32, 2016	No Restricted Materials Above Threshold
EU REACH Regulation (EC) No. 1907/2006	Current ECHA Candidate List: JUNE 2022 (224) Candidate List Declared Against: JAN 2022 (223) SVHC > Threshold: Not Yet Reviewed
Halogen Content	BFR/CFR/PVC Free, but Br/Cl >900 ppm in other sources.
Solder Process Capability	Not applicable for solder process capability

Product Compliance Disclaimer

This information is provided based on reasonable inquiry of our suppliers and represents our current actual knowledge based on the information they provided. This information is subject to change. The part numbers that TE has identified as EU RoHS compliant have a maximum concentration of 0.1% by weight in homogenous materials for lead, hexavalent chromium, mercury, PBB, PBDE, DBP, BBP, DEHP, DIBP, and 0.01% for cadmium, or qualify for an exemption to these limits as defined in the Annexes of Directive 2011/65/EU (RoHS2). Finished electrical and electronic equipment products will be CE marked as required by Directive 2011/65/EU. Components may not be CE marked. Additionally, the part numbers that TE has identified as EU ELV compliant have a maximum concentration of 0.1% by weight in homogenous materials for lead, hexavalent chromium, and mercury, and 0.01% for cadmium, or qualify for an exemption to these limits as defined in the Annexes of Directive 2000/53/EC (ELV). Regarding the REACH Regulation, the information TE provides on SVHC in articles for this part number is based on the latest European Chemicals Agency (ECHA) 'Guidance on requirements for substances in articles' posted at this URL: <https://echa.europa.eu/guidance-documents/guidance-on-reach>

Compatible Parts



TE Part # 144969-2
MQS0,63 Au rec LL unseal. 0,2-0,6



TE Part # 1379046-1
56pos MQS .63 header 90deg sld.



TE Part # 2-1579018-1
EXTRACTION TOOL

Also in the Series | MQS



Automotive Connector Caps & Covers (132)

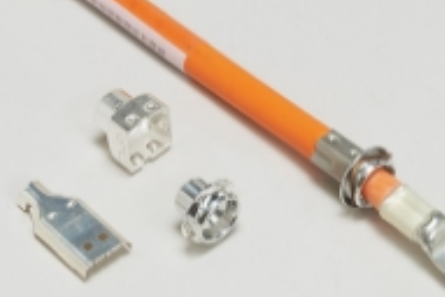

Automotive Connector EMC Shielding (2)



Automotive Connector Locks & Position Assurance(29)



Automotive Housings(489)



Automotive Seals & Cavity Plugs(26)



Automotive Terminals(96)



Insertion & Extraction Tools(42)



Other Automotive Connector Accessories(13)



PCB Headers & Receptacles(207)

Customers Also Bought

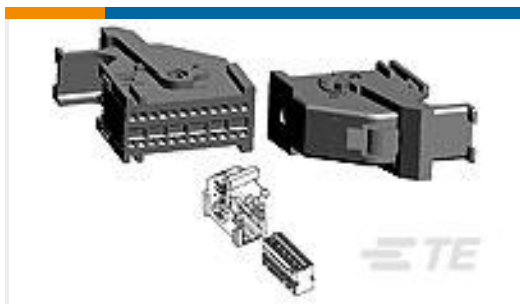

TE Part #284223-4
24 POS.KIT ASSY FOR AIR BAG (B



TE Part #348793-3
SHORTING CONN RECPT HSG.
ASSEM



TE Part #A88297-000
ES-CAP-HW-NO.1-X-35MM



TE Part #2005216-6
MCP 2.8 RETAINER HSG

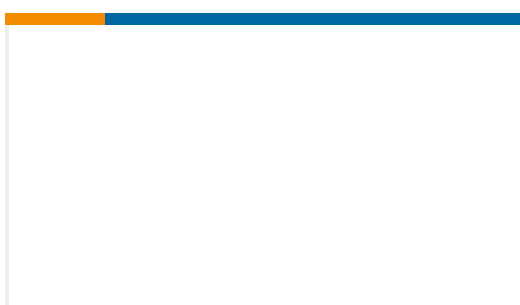

TE Part #2005210-2
TCU 68P PLUG ASSY



TE Part #2005215-6
MQS RETAINER HSG FOR 68P



TE Part #2005327-1
025/090/110 HYB 24P PLUG ASSY



TE Part #2278598-3
12POS MQS REC

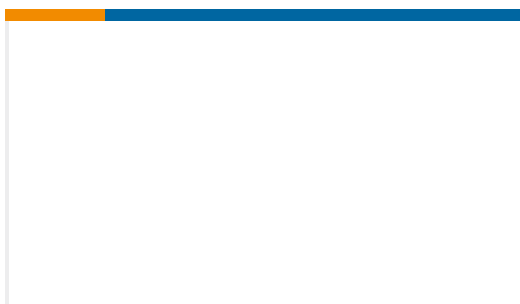

TE Part #2344391-1
43POS,MCON 1.2,REC HSG ASSY,SLD



TE Part #2357849-1
GWM VW AKII PIGTAIL Instead of GM
AKII

Documents



Product Drawings

32 POS KIT ASS'Y FOR AIR BAG

English

CAD Files

Customer View Model

[ENG_CVM_284423-7_A4.3d_igs.zip](#)

English

Customer View Model

[ENG_CVM_284423-7_A4.3d_stp.zip](#)

English

Customer View Model

[ENG_CVM_284423-7_A4.2d_dxf.zip](#)

English

3D PDF

3D

By downloading the CAD file I accept and agree to the [Terms and Conditions](#) of use.

Datasheets & Catalog Pages

Micro Quadlok Interconnection System (MQS)

English

Product Specifications

Application Specification

English

Instruction Sheets

Instruction Sheet (non U.S.)

English