

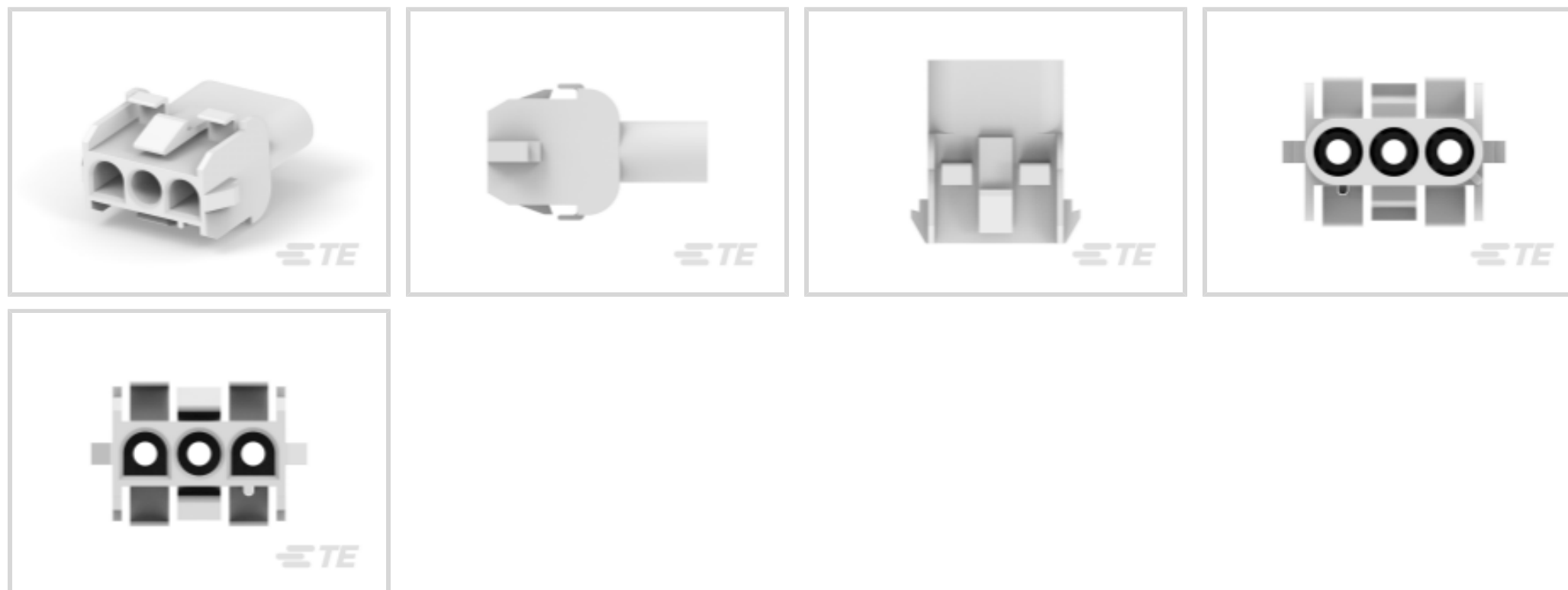

Connectors > Power Connectors > Rectangular Power > Rectangular Power Connectors



Rectangular Power Connector Type: **Housing**

Connector & Housing Type: **Receptacle**

Connector System: **Wire-to-Panel, Wire-to-Wire**

Number of Positions: **3**

Centerline (Pitch): **6.35 mm [ .25 in ]**

## Features

### Product Type Features

Rectangular Power Connector Type	Housing
Connector & Housing Type	Receptacle
Connector System	Wire-to-Panel, Wire-to-Wire
Sealable	No
Connector & Contact Terminates To	Wire & Cable

### Configuration Features

Number of Positions	3
Number of Rows	1

### Electrical Characteristics

Operating Voltage	600 VAC
-------------------	---------

### Contact Features

Multiple Contact Types	Without
Contact Layout	Inline
Contact Retention Within Housing	Without



Contact Type	Pin
--------------	-----

### Termination Features

Termination Method to Wire & Cable	Crimp
------------------------------------	-------

### Mechanical Attachment

Panel Mount Feature	With
---------------------	------

Panel Mount Feature Type	Patch & Tabs
--------------------------	--------------

Connector Mounting Type	Panel Mount
-------------------------	-------------

### Housing Features

Centerline (Pitch)	6.35 mm [.25 in]
--------------------	------------------

Housing Color	Natural
---------------	---------

Housing Material	GWT, Nylon 6/6, PA 66
------------------	-----------------------

### Dimensions

Panel Thickness	.76 – 2.29 mm [.03 – .09 in]
-----------------	------------------------------

### Usage Conditions

Operating Temperature Range	-55 – 105 °C [-67 – 221 °F]
-----------------------------	-----------------------------

### Operation/Application

Circuit Application	Power & Signal
---------------------	----------------

### Industry Standards

CSA Rating	Certified
------------	-----------

UL Flammability Rating	UL 94V-0
------------------------	----------

Glow Wire Rating	GWT 750°C (Without Flame)
------------------	---------------------------

UL Rating	Recognized
-----------	------------

Agency/Standard Number	E28476
------------------------	--------

CSA File Number	LR7189
-----------------	--------

VDE Tested	Yes
------------	-----

Agency/Standard	CSA, UL
-----------------	---------

### Packaging Features

Packaging Method	Package
------------------	---------

Packaging Quantity	1
--------------------	---

### Other

For Use With	MATE-N-LOK II Housings
--------------	------------------------



## Product Compliance



[For compliance documentation, visit the product page on TE.com>](#)

EU RoHS Directive 2011/65/EU	Compliant
EU ELV Directive 2000/53/EC	Compliant
China RoHS 2 Directive MIIT Order No 32, 2016	No Restricted Materials Above Threshold
EU REACH Regulation (EC) No. 1907/2006	Current ECHA Candidate List: JUNE 2022 (224) Candidate List Declared Against: JAN 2022 (223) SVHC > Threshold: Not Yet Reviewed
Halogen Content	Not Low Halogen - contains Br or Cl > 900 ppm.
Solder Process Capability	Not reviewed for solder process capability

### Product Compliance Disclaimer

This information is provided based on reasonable inquiry of our suppliers and represents our current actual knowledge based on the information they provided. This information is subject to change. The part numbers that TE has identified as EU RoHS compliant have a maximum concentration of 0.1% by weight in homogenous materials for lead, hexavalent chromium, mercury, PBB, PBDE, DBP, BBP, DEHP, DIBP, and 0.01% for cadmium, or qualify for an exemption to these limits as defined in the Annexes of Directive 2011/65/EU (RoHS2). Finished electrical and electronic equipment products will be CE marked as required by Directive 2011/65/EU. Components may not be CE marked. Additionally, the part numbers that TE has identified as EU ELV compliant have a maximum concentration of 0.1% by weight in homogenous materials for lead, hexavalent chromium, and mercury, and 0.01% for cadmium, or qualify for an exemption to these limits as defined in the Annexes of Directive 2000/53/EC (ELV). Regarding the REACH Regulation, the information TE provides on SVHC in articles for this part number is based on the latest European Chemicals Agency (ECHA) 'Guidance on requirements for substances in articles' posted at this URL: <https://echa.europa.eu/guidance-documents/guidance-on-reach>

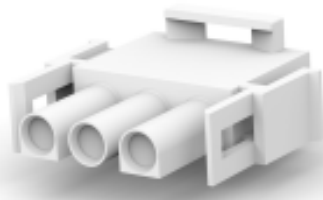
## Compatible Parts

 <p>TE Part # 1241809-2 UMNL ST-SOCK,A-P 3P</p>	 <p>TE Part # 794901-1 03P UMNL HI TEMP PLUG HSG</p>	 <p>TE Part # 2178473-3 3POS UMNL PLUG HSG GW</p>	 <p>TE Part # 2178473-2 3POS UMNL PLUG HSG V0 GW</p>
--	---	--	---



Also in the Series | **Universal MATE-N-LOK**

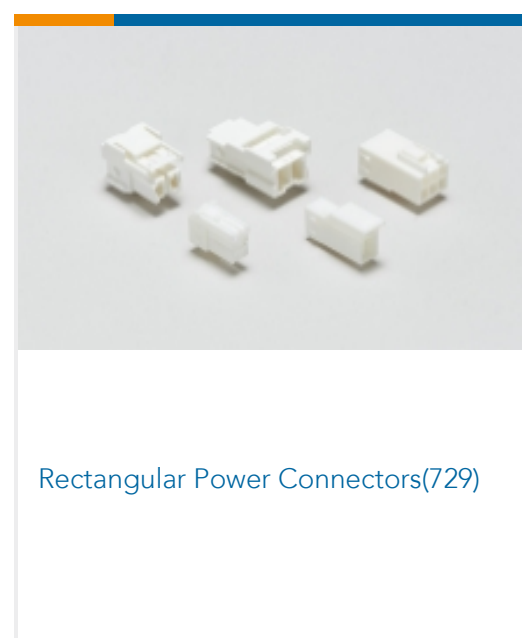
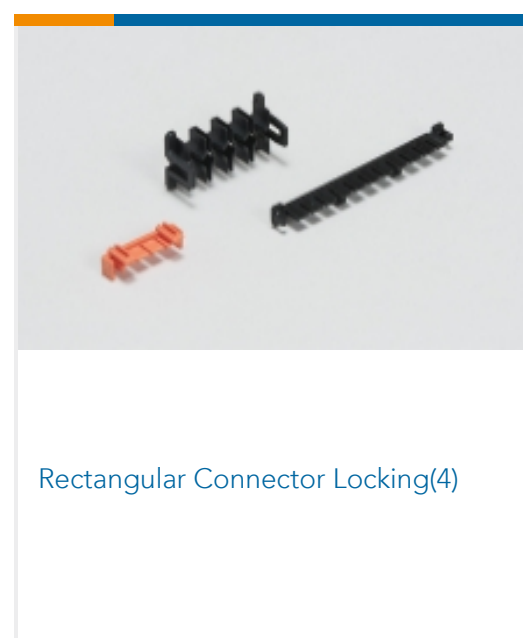
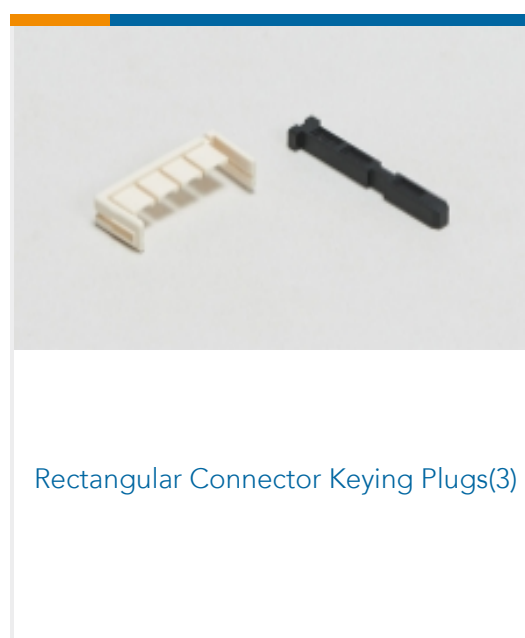
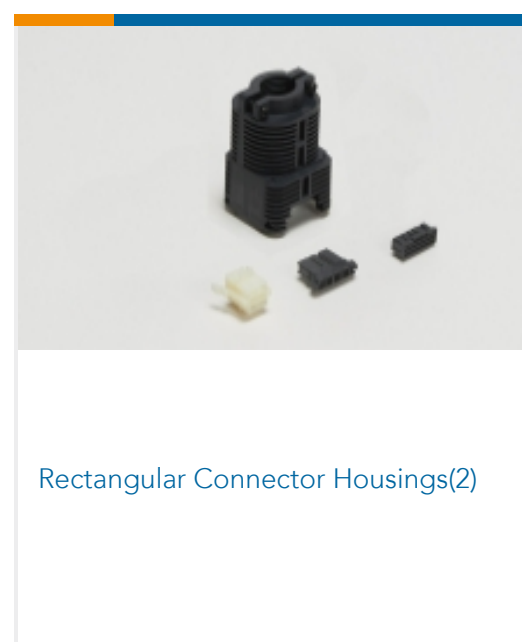
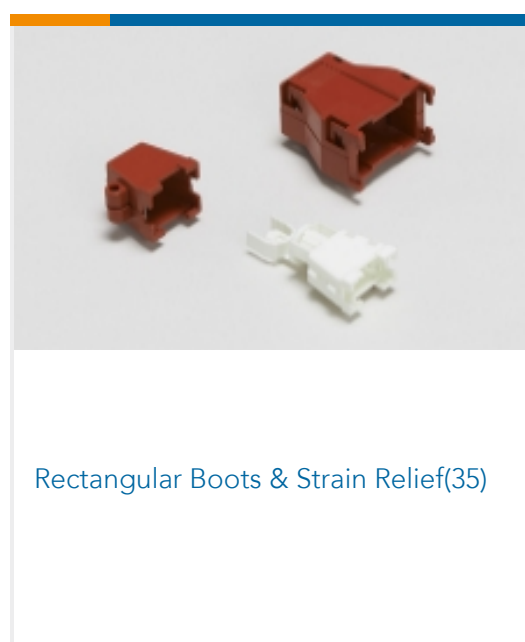
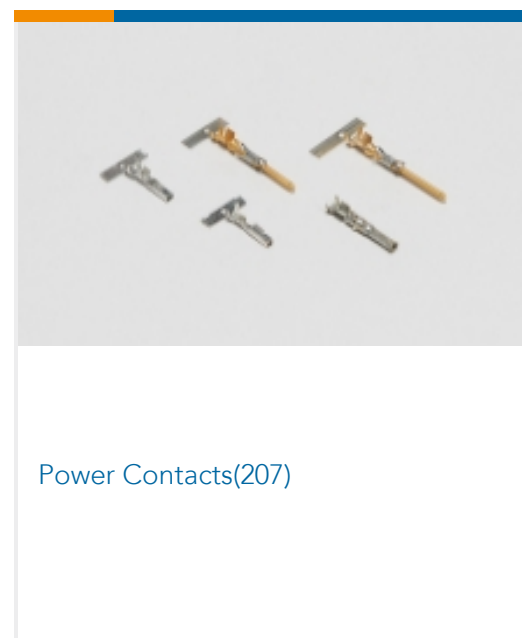
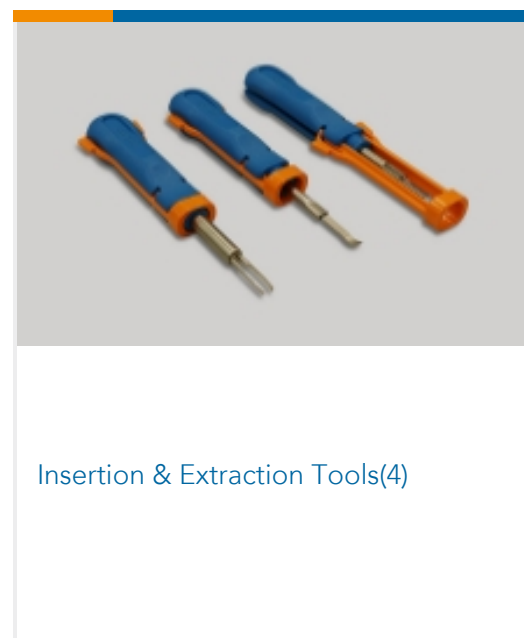
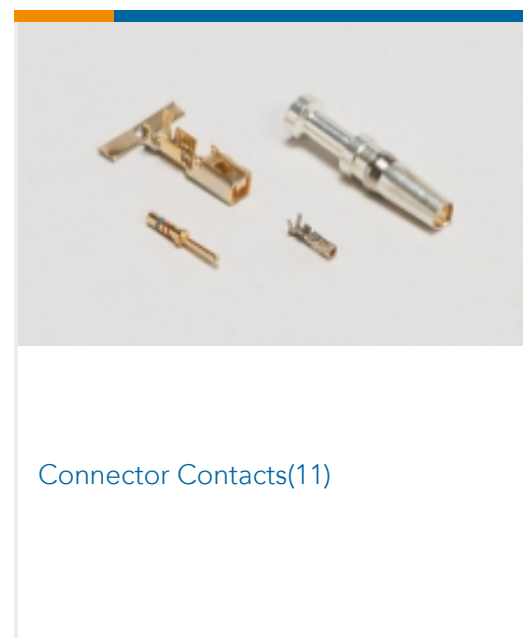
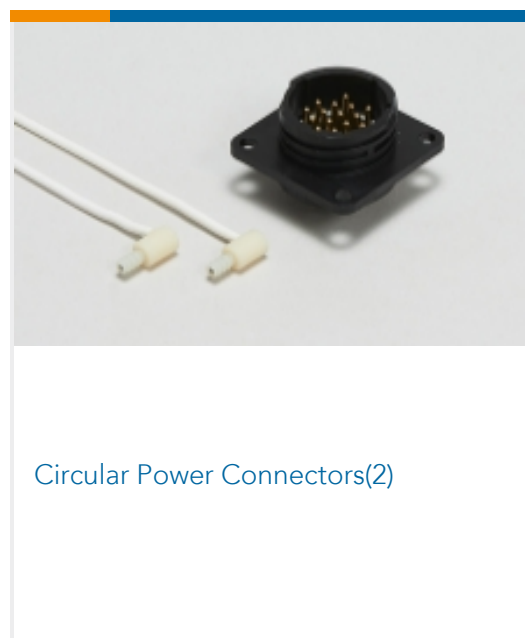

Customers Also Bought

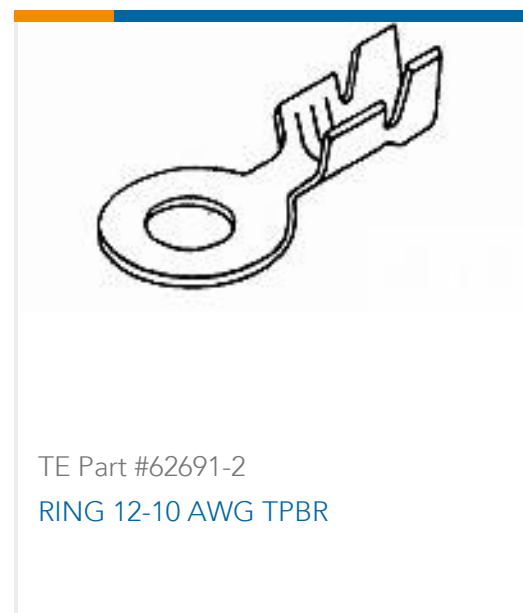
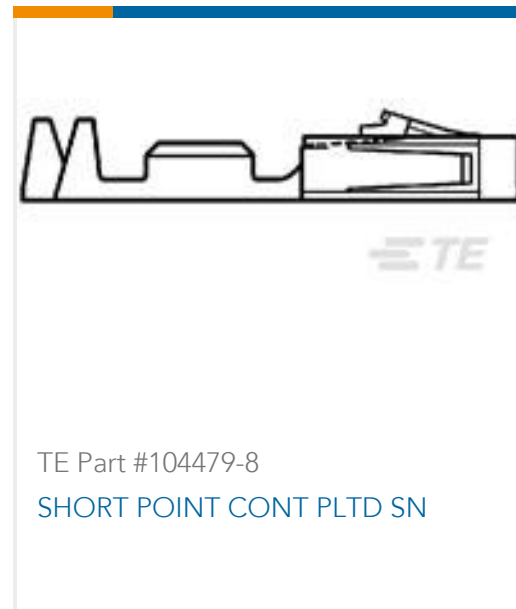

## Documents

### Product Drawings

[3POS UMNL CAP HSG V0 GW](#)

English

### CAD Files

[3D PDF](#)

3D

Customer View Model

[ENG\\_CVM\\_CVM\\_2178474-2\\_B.2d\\_dxf.zip](#)

English

Customer View Model

[ENG\\_CVM\\_CVM\\_2178474-2\\_B.3d\\_igs.zip](#)

English

Customer View Model

[ENG\\_CVM\\_CVM\\_2178474-2\\_B.3d\\_stp.zip](#)

English

By downloading the CAD file I accept and agree to the [Terms and Conditions](#) of use.

### Datasheets & Catalog Pages



[Glow Wire, V-0 Universal MATE-N-LOK Connector Housings Flyer](#)

English

---

[Product Environmental Compliance](#)

[MD\\_2178474-2\\_111620181046\\_dmtec](#)

English

[MD\\_2178474-2\\_111620181046\\_dmtec](#)

English

---

[Agency Approvals](#)

[VDE Certificate](#)

English