

2177588-3 ✓ ACTIVE

Nano MQS

TE Internal #: 2177588-3

TE Internal Description: 20POS NANO MQS TL PLUG HOUSING,
CODE C

MQS, CONNECTOR HOUSING

[View on TE.com >](#)

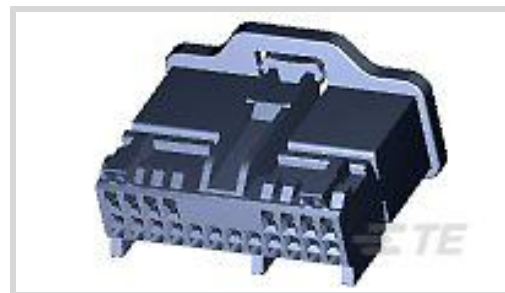

All MQS, CONNECTOR HOUSING (557)

Product Compliance

[For compliance documentation, visit the product page on TE.com>](#)

EU RoHS Directive 2011/65/EU	Compliant
EU ELV Directive 2000/53/EC	Compliant
China RoHS 2 Directive MIIT Order No 32, 2016	No Restricted Materials Above Threshold
EU REACH Regulation (EC) No. 1907/2006	Current ECHA Candidate List: JUNE 2022 (224) Candidate List Declared Against: JUNE 2022 (224) Does not contain REACH SVHC
Halogen Content	Low Halogen - Br, Cl, F, I < 900 ppm per homogenous material. Also BFR/CFR/PVC Free
Solder Process Capability	Not reviewed for solder process capability

Product Compliance Disclaimer

This information is provided based on reasonable inquiry of our suppliers and represents our current actual knowledge based on the information they provided. This information is subject to change. The part numbers that TE has identified as EU RoHS compliant have a maximum concentration of 0.1% by weight in homogenous materials for lead, hexavalent chromium, mercury, PBB, PBDE, DBP, BBP, DEHP, DIBP, and 0.01% for cadmium, or qualify for an exemption to these limits as defined in the Annexes of Directive 2011/65/EU (RoHS2). Finished electrical and electronic equipment products will be CE marked as required by Directive 2011/65/EU. Components may not be CE marked. Additionally, the part numbers that TE has identified as EU ELV compliant have a maximum concentration of 0.1% by weight in homogenous materials for lead, hexavalent chromium, and mercury, and 0.01% for cadmium, or qualify for an exemption to these limits as defined in the Annexes of Directive 2000/53/EC (ELV). Regarding the REACH Regulation, the information TE provides on SVHC in articles for this part number is based on the latest European Chemicals Agency (ECHA) 'Guidance on requirements for substances in articles' posted at this URL: <https://echa.europa.eu/guidance-documents/guidance-on-reach>

Compatible Parts



Also in the Series | Nano MQS

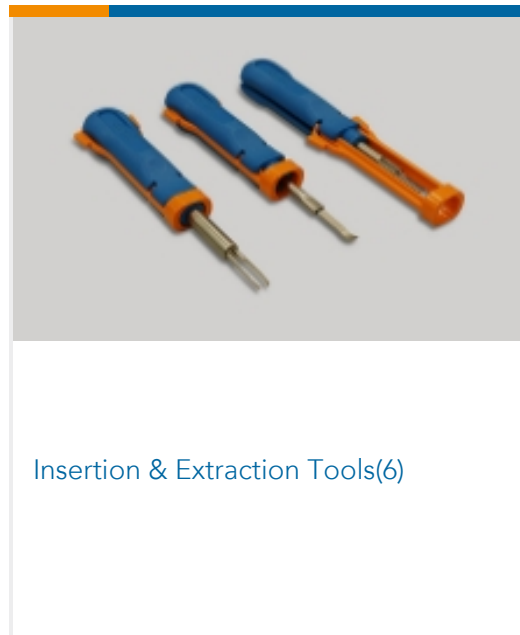
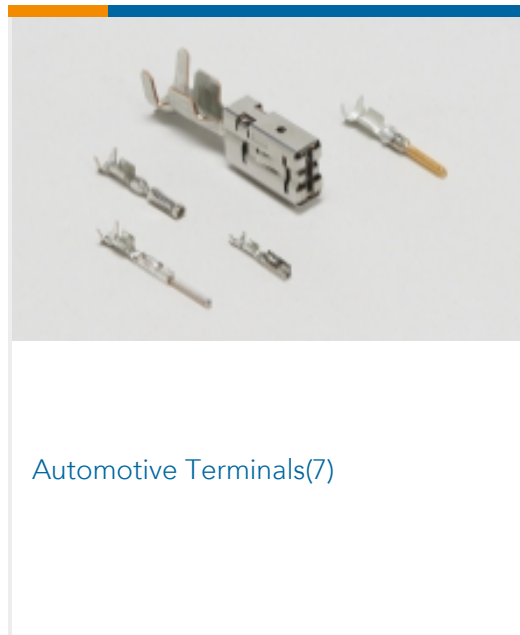
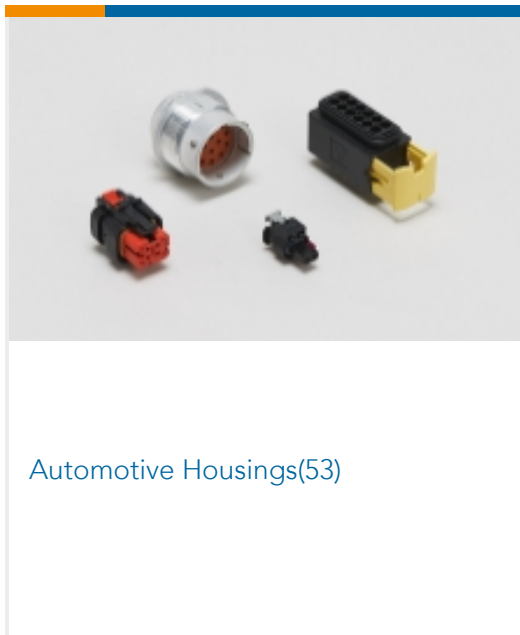

Customers Also Bought

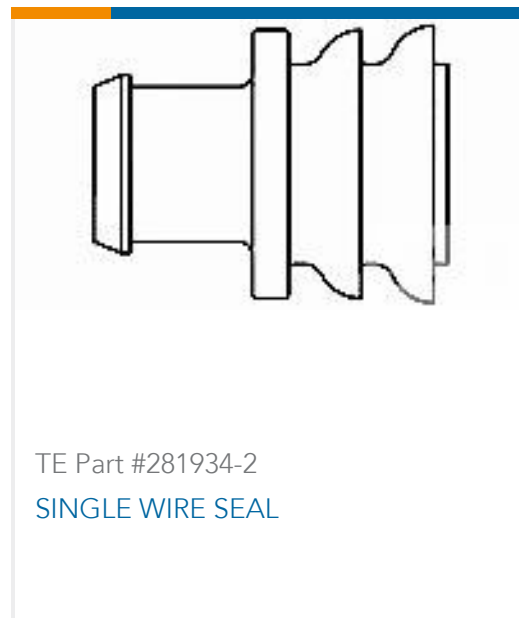
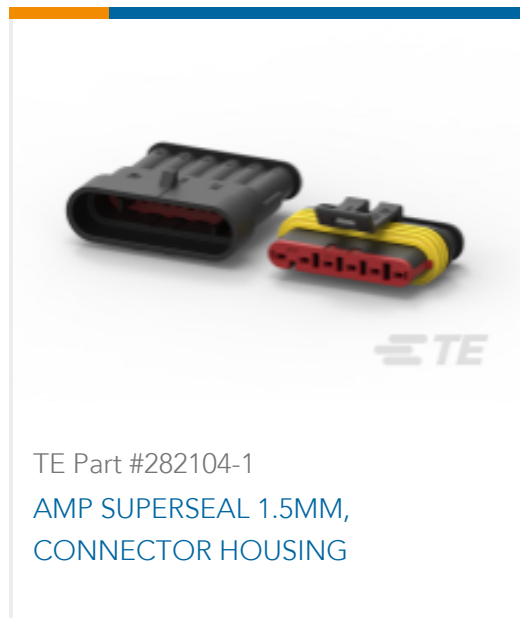
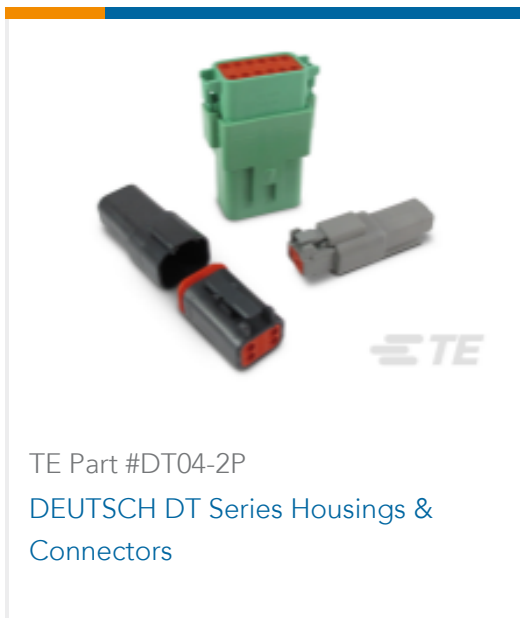

Documents

Product Drawings

20POS NANO MQS TL PLUG HOUSING, CODE C

English

CAD Files

3D PDF

3D



Customer View Model

[ENG_CVM_CVM_2177588-3_G_c-2177588-3-g.2d_dxf.zip](#)

English

Customer View Model

[ENG_CVM_CVM_2177588-3_G_c-2177588-3-g.3d_igs.zip](#)

English

Customer View Model

[ENG_CVM_CVM_2177588-3_G_c-2177588-3-g.3d_stp.zip](#)

English

By downloading the CAD file I accept and agree to the [Terms and Conditions](#) of use.

Datasheets & Catalog Pages

[Micro Quadlok Interconnection System \(MQS\)](#)

English

Product Specifications

[Product Specification](#)

English