

2141861-3 ✓ ACTIVE

MCON Interconnection System

TE Internal #: 2141861-3

Automotive Terminals, Receptacle, Mating Tab Width 1.2 mm [.047 in], Tab Thickness .024 in [.6 mm], 26 – 24 AWG Wire Size, MCON Interconnection System

[View on TE.com >](#)



Terminals & Splices > Automotive Terminals > MCON, RECEPTACLE AND TAB

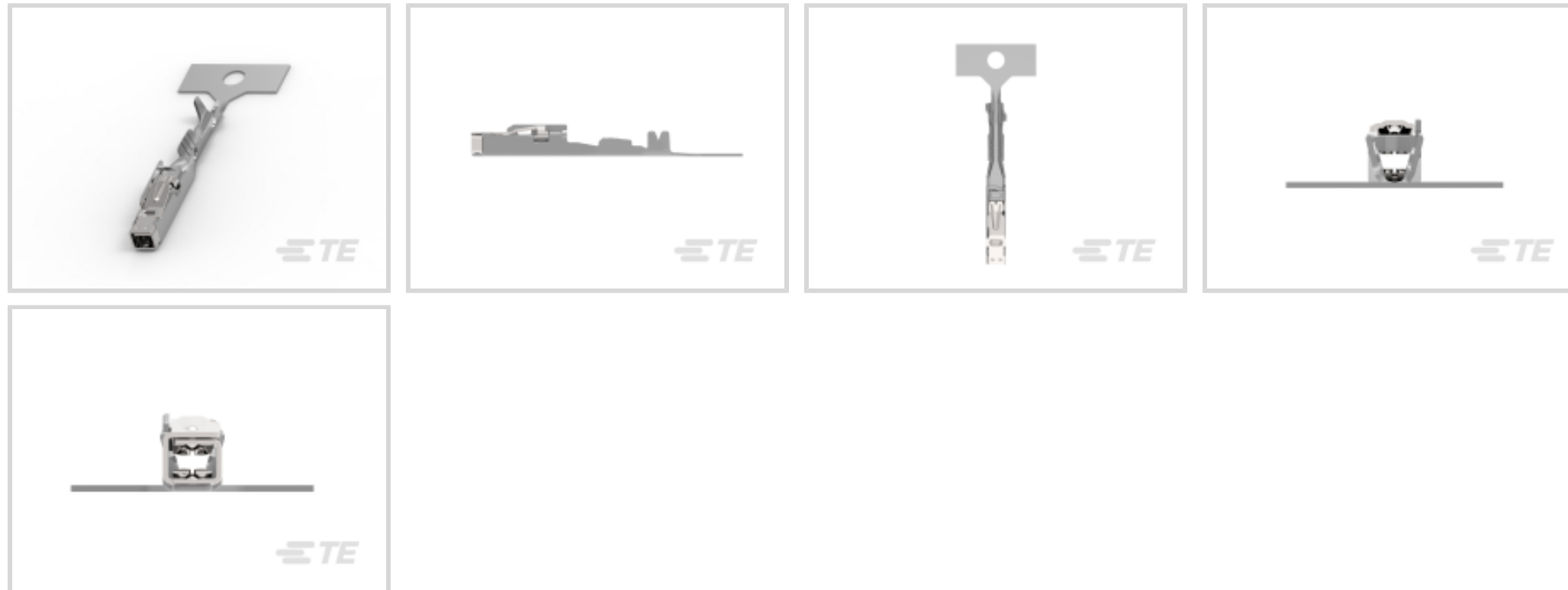

Terminal Type: **Receptacle**

Mating Tab Width: 1.2 mm [.047 in]

Mating Tab Thickness: .6 mm [.024 in]

Terminal Transmits: 0 – 24 A (Low Power)

Wire Size: 26 – 24 AWG

[All MCON, RECEPTACLE AND TAB \(103\)](#)

Features

Product Type Features

Receptacle Style	180°
Sealable	No
Primary Locking Feature	Locking Lance

Contact Features

Contact Size	1.2mm
Contact Fabrication	Stamped & Formed
Typical Current Rating	7 A
Crimp Type	F-Crimp
Terminal Type	Receptacle
Mating Tab Width	1.2 mm [.047 in]
Mating Tab Thickness	.6 mm [.024 in]
Interface Plating	Silver (Ag)
Contact Termination Area Plating Material	Tin (Sn)



Termination Features

Termination Method to Wire & Cable	Crimp
Product Terminates To	Wire

Dimensions

Wire Size	.13 – .22 mm ²
Wire Size Search	24 AWG, 25 AWG, 26 AWG
Wire Insulation Diameter	.85 – 1.2 mm [.033 – .047 in]

Usage Conditions

Insulation Option	Uninsulated
Operating Temperature (Max)	80 °C, 85 °C, 90 °C, 100 °C, 105 °C, 110 °C, 120 °C, 125 °C, 130 °C, 140 °C, 145 °C, 150 °C [176 °F][185 °F][194 °F][212 °F][221 °F][230 °F][248 °F][257 °F][266 °F][284 °F][293 °F][302 °F]
Operating Temperature Range	-40 – 150 °C [-40 – 302 °F]

Operation/Application

Compatible With Wire Base Material	Copper
------------------------------------	--------

Industry Standards

Agency/Standard	LV214
-----------------	-------

Packaging Features

Packaging Method	Reel
Packaging Quantity	10000

Other

Terminal Transmits	0 – 24 A (Low Power)
--------------------	----------------------

Product Compliance

For compliance documentation, visit the product page on TE.com>

EU RoHS Directive 2011/65/EU	Compliant
EU ELV Directive 2000/53/EC	Compliant
China RoHS 2 Directive MIIT Order No 32, 2016	No Restricted Materials Above Threshold
EU REACH Regulation (EC) No. 1907/2006	Current ECHA Candidate List: JUNE 2022 (224) Candidate List Declared Against: JAN 2022 (223)



SVHC > Threshold:
Not Yet Reviewed

Halogen Content
Low Halogen - Br, Cl, F, I < 900 ppm per homogenous material. Also BFR/CFR/PVC Free

Solder Process Capability
Not reviewed for solder process capability

Product Compliance Disclaimer

This information is provided based on reasonable inquiry of our suppliers and represents our current actual knowledge based on the information they provided. This information is subject to change. The part numbers that TE has identified as EU RoHS compliant have a maximum concentration of 0.1% by weight in homogenous materials for lead, hexavalent chromium, mercury, PBB, PBDE, DBP, BBP, DEHP, DIBP, and 0.01% for cadmium, or qualify for an exemption to these limits as defined in the Annexes of Directive 2011/65/EU (RoHS2). Finished electrical and electronic equipment products will be CE marked as required by Directive 2011/65/EU. Components may not be CE marked. Additionally, the part numbers that TE has identified as EU ELV compliant have a maximum concentration of 0.1% by weight in homogenous materials for lead, hexavalent chromium, and mercury, and 0.01% for cadmium, or qualify for an exemption to these limits as defined in the Annexes of Directive 2000/53/EC (ELV). Regarding the REACH Regulation, the information TE provides on SVHC in articles for this part number is based on the latest European Chemicals Agency (ECHA) 'Guidance on requirements for substances in articles' posted at this URL: <https://echa.europa.eu/guidance-documents/guidance-on-reach>

Compatible Parts



TE Part # 2305570-1
TERMINAL CUTTER, SIDE FEED



TE Part # 2-1670442-9
38POS, MIXED, REC. HSG



TE Part # 2-2151333-1
OCEAN_2.0_APPLICATOR-S-040F062O



TE Part # 2-2151333-2
OCEAN_2.0_APPLICATOR-S-040F062O



TE Part # 2-4151061-1
APPLICATOR TO MAKE LOOSE PIECE TERMINALS



TE Part # 2-4151061-2
APPLICATOR TO MAKE LOOSE PIECE TERMINALS



TE Part # 2151333-1
OCEAN_2.0_APPLICATOR-S-040F062O



TE Part # 2151333-2
OCEAN_2.0_APPLICATOR-S-040F062O



TE Part # 4151061-1
APPLICATOR TO MAKE LOOSE PIECE TERMINALS



TE Part # 4151061-2
APPLICATOR TO MAKE LOOSE PIECE TERMINALS



TE Part # 7-2151333-1
OCEAN_2.0_APPLICATOR-S-040F062O



TE Part # 7-2151333-2
OCEAN_2.0_APPLICATOR-S-040F062O





KIT

REPRESENTATION ONLY

TE Part # 7-2151333-7
OCEAN_2.0_SPARE_PART_KIT-040F062O



TE Part # 7-4151061-1
APPLICATOR TO MAKE LOOSE PIECE TERMINALS



TE Part # 7-4151061-2
APPLICATOR TO MAKE LOOSE PIECE TERMINALS

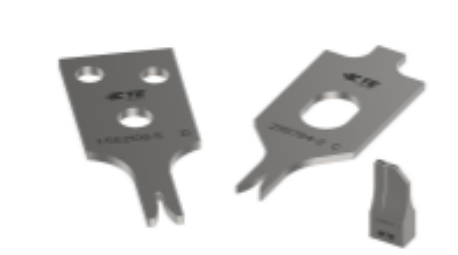

KIT

REPRESENTATION ONLY

TE Part # 7-4151061-7
TOOLING KIT TO MAKE LOOSE PIECE TERMINAL

TE Part # 2382871-1
16POS,MCON 1.2,REC HSG ASSY, UNSLD,COD A

TE Part # 2382871-2
16POS,MCON 1.2,REC HSG ASSY, UNSLD,COD A

TE Part # 2382871-3
16POS,MCON 1.2,REC HSG ASSY, UNSLD,COD A

TE Part # 2382871-4
16POS,MCON 1.2,REC HSG ASSY, UNSLD,COD A

Also in the Series | MCON Interconnection System



Automotive Connector Caps & Covers (24)



Automotive Connector Locks & Position Assurance(11)



Automotive Housings(288)



Automotive Seals & Cavity Plugs(4)



Automotive Terminals(113)



Insertion & Extraction Tools(31)



Other Automotive Connector Accessories(6)



PCB Headers & Receptacles(1)

Customers Also Bought



TE Part #DT04-2P
DEUTSCH DT Series Housings & Connectors



TE Part #W2S
DEUTSCH DT WEDGELOCKS



TE Part #282104-1
AMP SUPERSEAL 1.5MM, CONNECTOR HOUSING

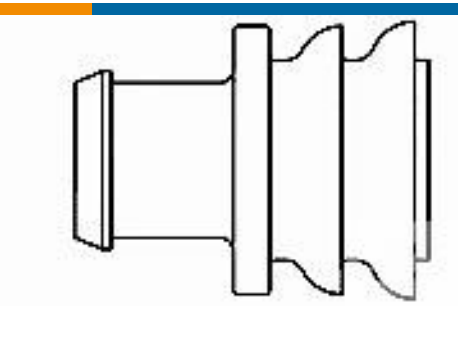

TE Part #281934-2
SINGLE WIRE SEAL



Documents

Product Drawings

MCON 1.2 LL REC SRC AG

English

CAD Files

3D PDF

3D

Customer View Model

[ENG_CVM_CVM_2141861-3_A.2d_dxf.zip](#)

English

Customer View Model

[ENG_CVM_CVM_2141861-3_A.3d_igs.zip](#)

English

Customer View Model

[ENG_CVM_CVM_2141861-3_A.3d_stp.zip](#)

English

By downloading the CAD file I accept and agree to the [Terms and Conditions](#) of use.

Datasheets & Catalog Pages

MCON Interconnection System

English

Product Specifications

Product Specification

English