

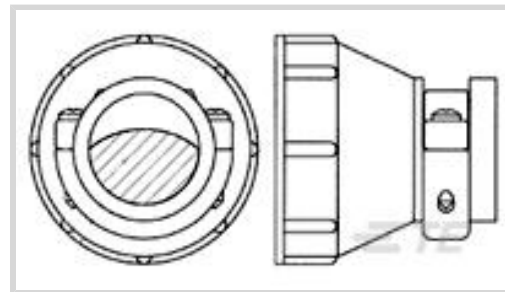

[Connectors](#) > [Circular Connectors](#) > [Circular Connector Accessories](#) > [Unscreened Circular Connector Backshells & Clamps](#) >

CPC SERIES 5 SEALED CABLE CLAMP



Backshell & Clamp Accessory Type: **Cable Clamp**

Compatible With Circular Connector Shell Size: **17**

Body Orientation: **Straight**

Accepts Cable Diameter (Max): **17.86 mm [.703 in]**

Protective Cover: **Without**

[All CPC SERIES 5 SEALED CABLE CLAMP \(2\)](#)

Features

Product Type Features

| | |
|----------------------------------|-------------|
| Product Type | Accessory |
| Backshell & Clamp Accessory Type | Cable Clamp |
| Protective Cover | Without |

Body Features

| | |
|---------------------------------|----------|
| Cable Clamp Material | Nylon |
| Cable Clamp Flammability Rating | UL 94V-1 |
| Cable Clamp Color | Black |

Mechanical Attachment

| | |
|--------------------------|------------------------------|
| Screw Plating Material | Zinc with Trivalent Chromate |
| Screw & Hole Thread Size | 15/16-20 |

Housing Features

| | |
|------------------|----------|
| Body Orientation | Straight |
|------------------|----------|

Dimensions

| | |
|------------------------------|-------------------|
| Accepts Cable Diameter (Max) | 17.86 mm[.703 in] |
|------------------------------|-------------------|

Operation/Application

| | |
|---|----|
| Compatible With Circular Connector Shell Size | 17 |
|---|----|



Packaging Features

| | |
|--------------------|------------|
| Packaging Quantity | 1 |
| Packaging Method | Individual |

Product Compliance

[For compliance documentation, visit the product page on TE.com>](#)

| | |
|---|--|
| EU RoHS Directive 2011/65/EU | Compliant |
| EU ELV Directive 2000/53/EC | Compliant |
| China RoHS 2 Directive MIIT Order No 32, 2016 | No Restricted Materials Above Threshold |
| EU REACH Regulation (EC) No. 1907/2006 | Current ECHA Candidate List: JUNE 2022 (224) Candidate List Declared Against: JAN 2022 (223) SVHC > Threshold: Not Yet Reviewed |
| Halogen Content | Low Halogen - Br, Cl, F, I < 900 ppm per homogenous material. Also BFR/CFR/PVC Free |
| Solder Process Capability | Not applicable for solder process capability |

Product Compliance Disclaimer

This information is provided based on reasonable inquiry of our suppliers and represents our current actual knowledge based on the information they provided. This information is subject to change. The part numbers that TE has identified as EU RoHS compliant have a maximum concentration of 0.1% by weight in homogenous materials for lead, hexavalent chromium, mercury, PBB, PBDE, DBP, BBP, DEHP, DIBP, and 0.01% for cadmium, or qualify for an exemption to these limits as defined in the Annexes of Directive 2011/65/EU (RoHS2). Finished electrical and electronic equipment products will be CE marked as required by Directive 2011/65/EU. Components may not be CE marked. Additionally, the part numbers that TE has identified as EU ELV compliant have a maximum concentration of 0.1% by weight in homogenous materials for lead, hexavalent chromium, and mercury, and 0.01% for cadmium, or qualify for an exemption to these limits as defined in the Annexes of Directive 2000/53/EC (ELV). Regarding the REACH Regulation, the information TE provides on SVHC in articles for this part number is based on the latest European Chemicals Agency (ECHA) 'Guidance on requirements for substances in articles' posted at this URL: <https://echa.europa.eu/guidance-documents/guidance-on-reach>

Compatible Parts

| | | | |
|--|---|--|--|
|  <p>TE Part # 213906-1 CPC PLUG ASSY, SRS 6, SZ 17-10</p> |  <p>TE Part # 213902-2 CPC CBL CLMP KIT, LRG, SZ17, BULK</p> |  <p>TE Part # 213905-1 CPC PLUG ASSY, SERIES 5, SZ 17-3</p> |  <p>TE Part # 213899-1 CPC SEAL ASSY KIT, SRS 5, 17-3</p> |
|--|---|--|--|



Also in the Series | AMP CPC

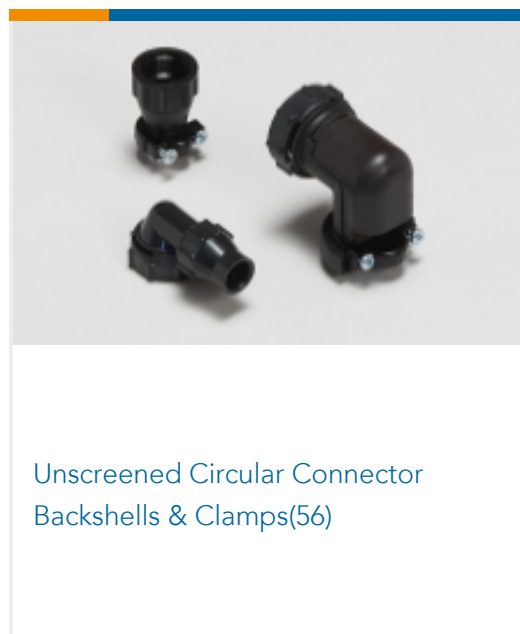
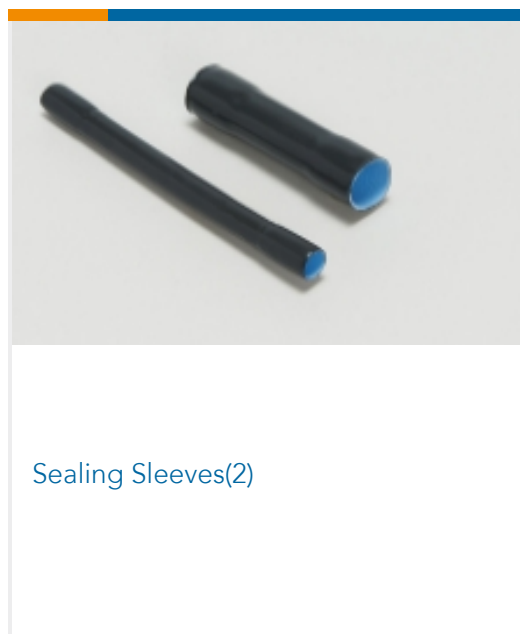
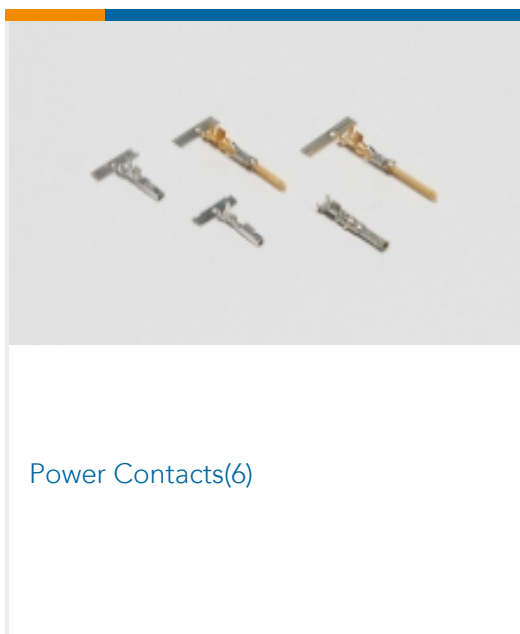
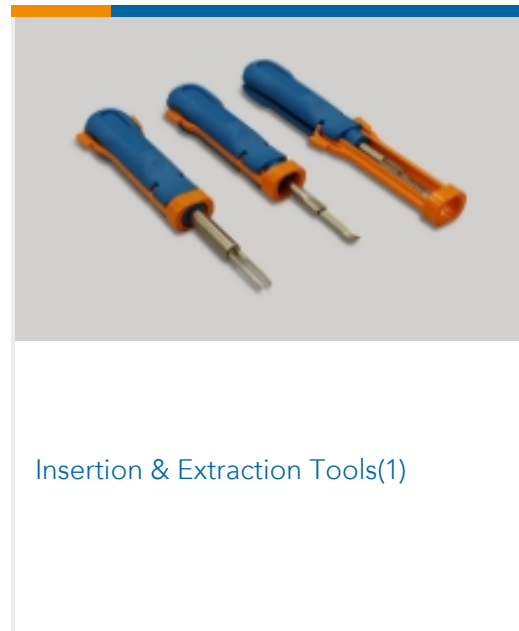
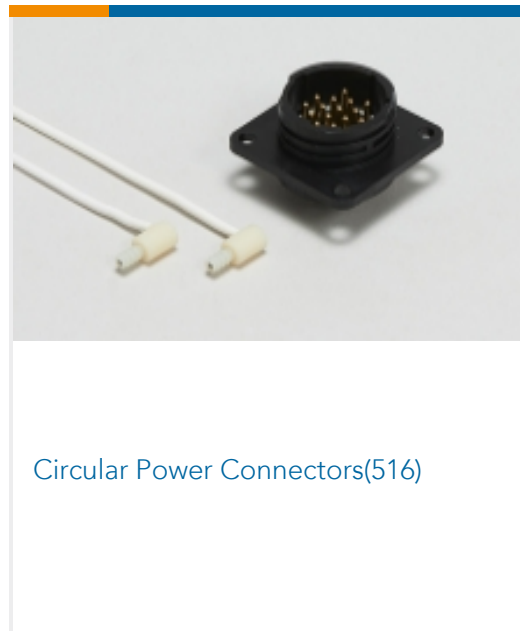
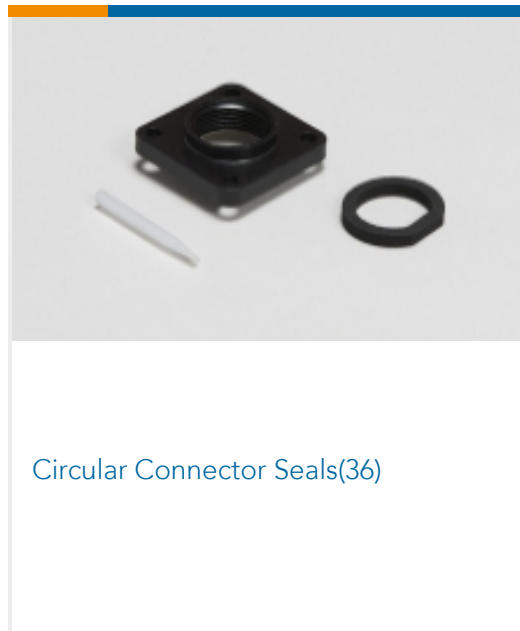
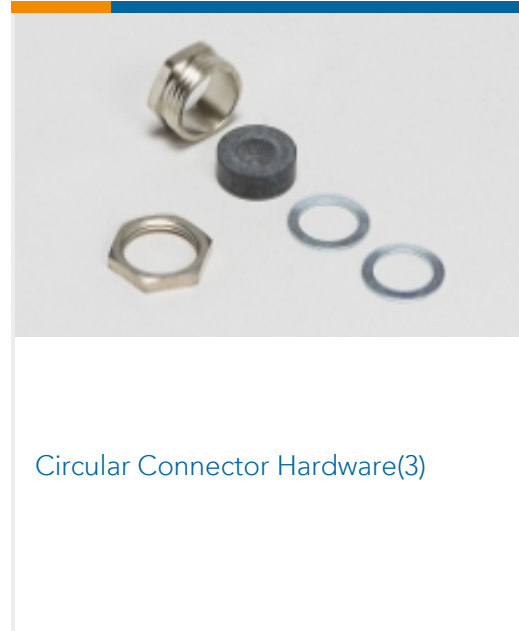
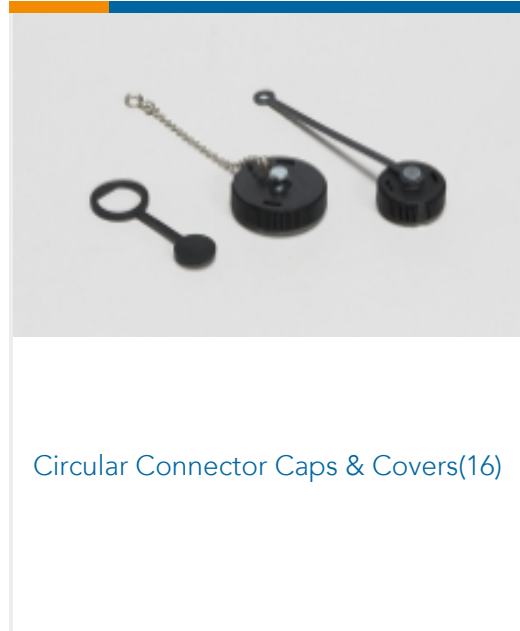
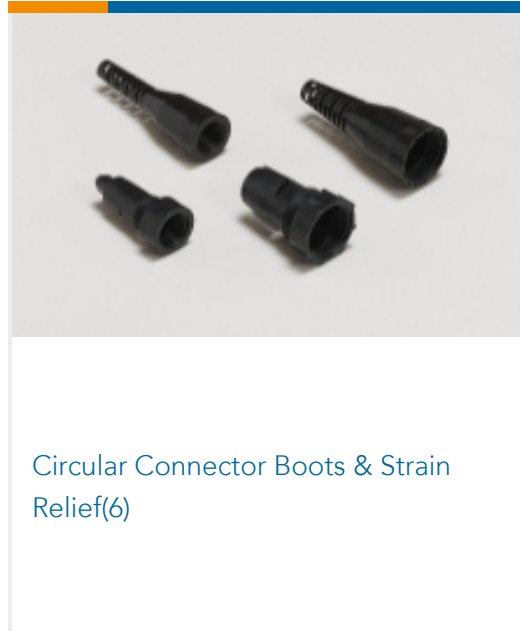
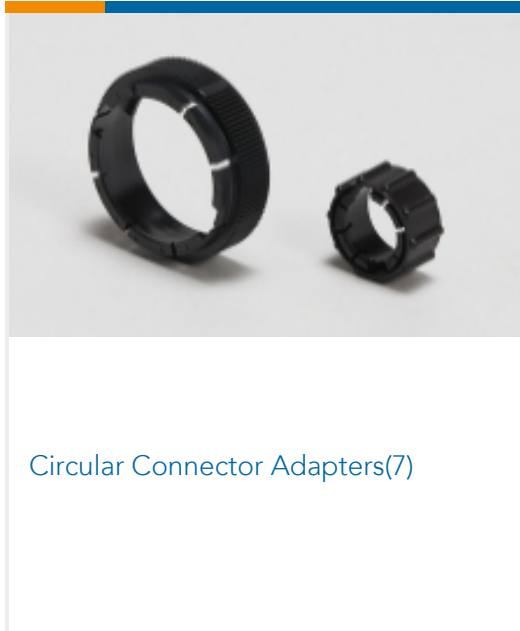

Customers Also Bought

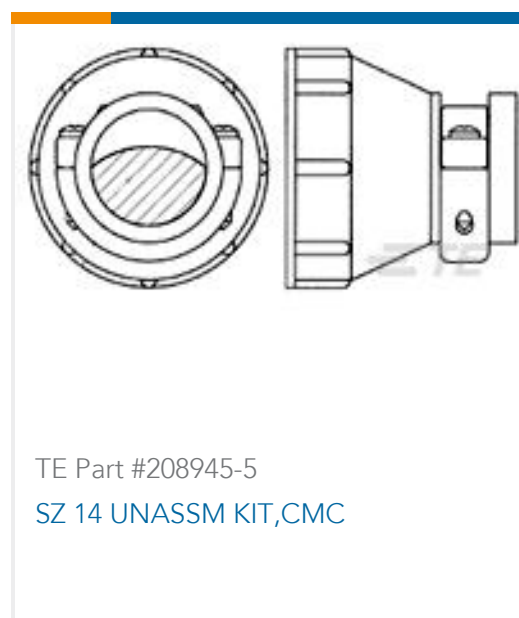



TE Part #206306-1
23-37 RECEPT REV SEX



TE Part #4-1393238-4
RTB74012

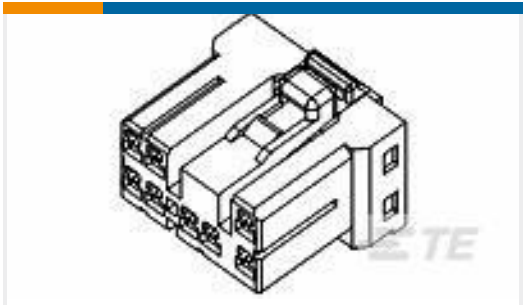

TE Part #176118-6
070 MLC II PLUG ASSY 18P GRAY

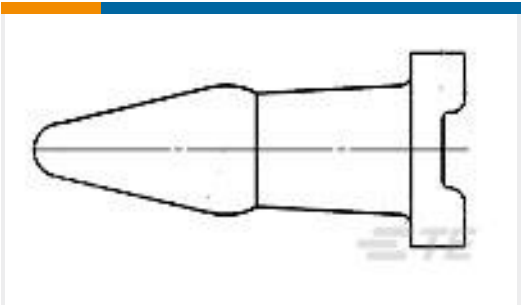

TE Part #212980-1
PLUG,SEAL,ECMSC

Documents

Product Drawings

[CPC CABLE CLAMP KIT,LRG,SZ 17](#)

English

CAD Files

Customer View Model

[ENG_CVM_213902-3_B.2d_dxf.zip](#)

English

3D PDF

English

Customer View Model

[ENG_CVM_213902-3_B.3d_igs.zip](#)

English

Customer View Model

[ENG_CVM_213902-3_B.3d_stp.zip](#)

English

By downloading the CAD file I accept and agree to the [Terms and Conditions](#) of use.

Product Specifications

[Product Specification](#)

English

Product Environmental Compliance

[TE Material Declaration](#)

English

Agency Approvals

[CSA Certificate](#)

English