

2137358-4 ✓ ACTIVE

AMP MCP 2.8, AMP MCP Connector System

TE Internal #: 2137358-4

Housing for Female Terminals, Wire-to-Wire, 18 Position, .098 in [2.5 mm] Centerline, Violet, Wire & Cable, Signal, Cable Mount (Free-Hanging), Hybrid

[View on TE.com >](#)



Connectors > Automotive Connectors > Connector Housings > AMP MCP, UNSEALED CONNECTOR HOUSING



Connector & Housing Type: **Housing for Female Terminals**

Mating Tab Width: **2.8 mm [.11 in]**

Connector System: **Wire-to-Wire**

Number of Positions: **18**

Centerline (Pitch): **2.5 mm [.098 in]**

[All AMP MCP, UNSEALED CONNECTOR HOUSING \(187\)](#)

Features

Product Type Features

Connector & Housing Shape	Rectangular
Connector & Housing Type	Housing for Female Terminals
Connector System	Wire-to-Wire
Sealable	No
Hybrid Connector	No
Primary Locking Feature	Integrated in Housing
Connector & Contact Terminates To	Wire & Cable

Configuration Features

Number of Positions	18
Number of Rows	3

Electrical Characteristics

Operating Voltage	28 VDC
-------------------	--------



Nominal Voltage Architecture	12 V, 24 V
------------------------------	------------

Body Features

Cable Exit Angle	180°
Body Material	PBT GF
Primary Product Color	Violet
Connector Code	D

Contact Features

Contact Size	2.8mm
Contact Type	Receptacle
Mating Tab Width	2.8 mm[.11 in]

Mechanical Attachment

Mounting Feature	Without
Terminal Position Assurance	No
Strain Relief	With
Mating Alignment Type	Keyed
Mating Alignment	With
Connector Mounting Type	Cable Mount (Free-Hanging)

Housing Features

Centerline (Pitch)	2.5 mm[.098 in]
--------------------	-----------------

Dimensions

Row-to-Row Spacing	5.5 mm[.216 in]
--------------------	-----------------

Usage Conditions

Operating Temperature (Max)	70 °C, 75 °C, 80 °C, 85 °C, 90 °C, 100 °C, 105 °C, 110 °C, 120 °C[158 °F][167 °F][176 °F][185 °F][194 °F][212 °F][221 °F][230 °F][248 °F]
Operating Temperature Range	-40 – 120 °C[-40 – 248 °F]

Operation/Application

Circuit Application	Signal
---------------------	--------

Industry Standards

Degree of Protection	IP30
----------------------	------

Packaging Features

Packaging Quantity	350
--------------------	-----



Packaging Method	Package
------------------	---------

Other

Serviceable	No
Connector Position Assurance Capable	No

Product Compliance

[For compliance documentation, visit the product page on TE.com>](#)

EU RoHS Directive 2011/65/EU	Compliant
EU ELV Directive 2000/53/EC	Compliant
China RoHS 2 Directive MIIT Order No 32, 2016	No Restricted Materials Above Threshold
EU REACH Regulation (EC) No. 1907/2006	Current ECHA Candidate List: JUNE 2022 (224) Candidate List Declared Against: JAN 2022 (223) SVHC > Threshold: Not Yet Reviewed
Halogen Content	Low Halogen - Br, Cl, F, I < 900 ppm per homogenous material. Also BFR/CFR/PVC Free
Solder Process Capability	Not reviewed for solder process capability

Product Compliance Disclaimer

This information is provided based on reasonable inquiry of our suppliers and represents our current actual knowledge based on the information they provided. This information is subject to change. The part numbers that TE has identified as EU RoHS compliant have a maximum concentration of 0.1% by weight in homogenous materials for lead, hexavalent chromium, mercury, PBB, PBDE, DBP, BBP, DEHP, DIBP, and 0.01% for cadmium, or qualify for an exemption to these limits as defined in the Annexes of Directive 2011/65/EU (RoHS2). Finished electrical and electronic equipment products will be CE marked as required by Directive 2011/65/EU. Components may not be CE marked. Additionally, the part numbers that TE has identified as EU ELV compliant have a maximum concentration of 0.1% by weight in homogenous materials for lead, hexavalent chromium, and mercury, and 0.01% for cadmium, or qualify for an exemption to these limits as defined in the Annexes of Directive 2000/53/EC (ELV). Regarding the REACH Regulation, the information TE provides on SVHC in articles for this part number is based on the latest European Chemicals Agency (ECHA) 'Guidance on requirements for substances in articles' posted at this URL: <https://echa.europa.eu/guidance-documents/guidance-on-reach>

Compatible Parts



TE Part # 2137352-4
AMP-MCP 2.8mm TAB HOUSING,
18POS

Also in the Series | AMP MCP 2.8



Automotive Connector Caps & Covers
(1)

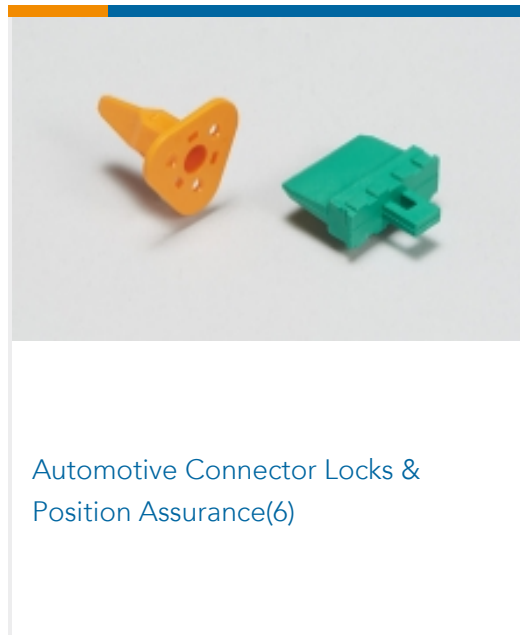

Automotive Connector Locks &
Position Assurance(6)

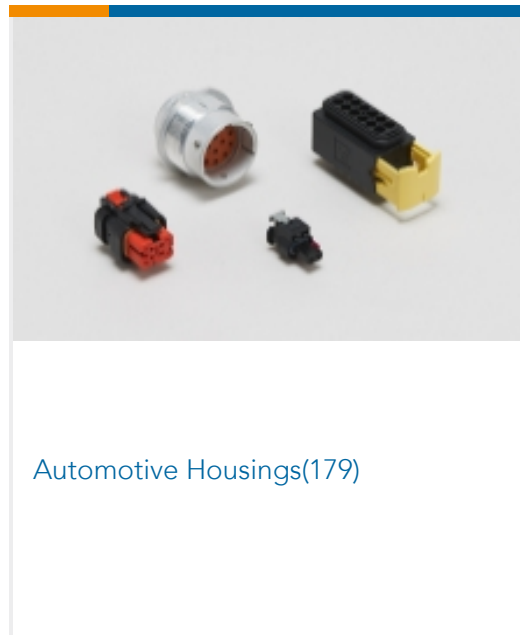

Automotive Housings(179)

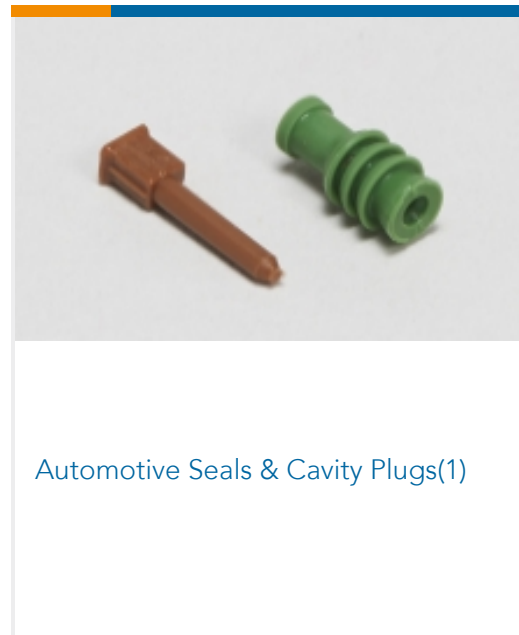

Automotive Seals & Cavity Plugs(1)

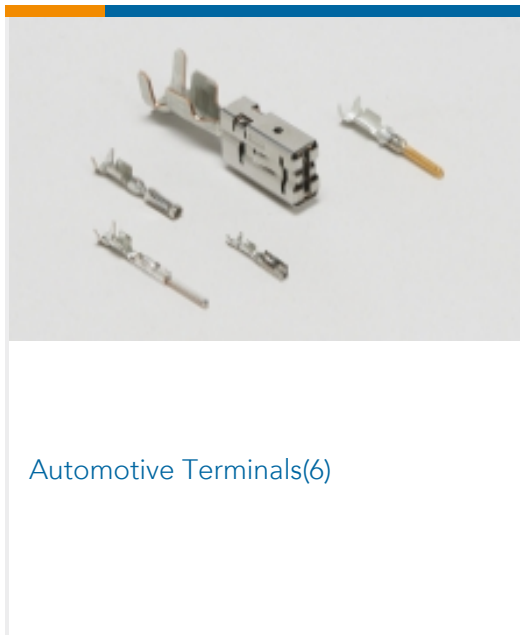

Automotive Terminals(6)

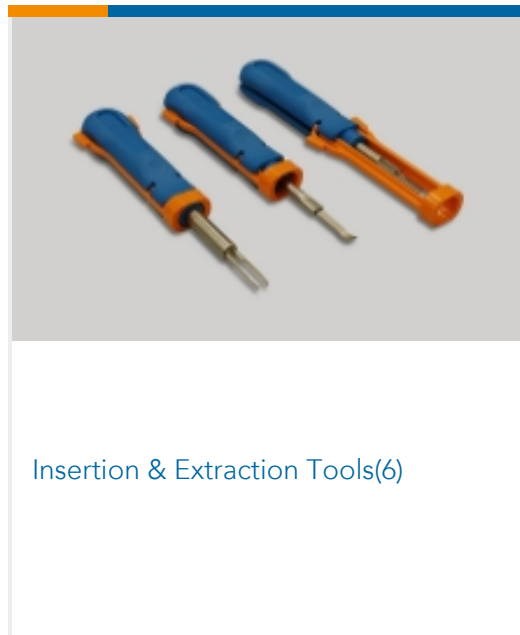

Insertion & Extraction Tools(6)



Module Components(1)



PCB Headers & Receptacles(1)

Also in the Series | AMP MCP Connector System

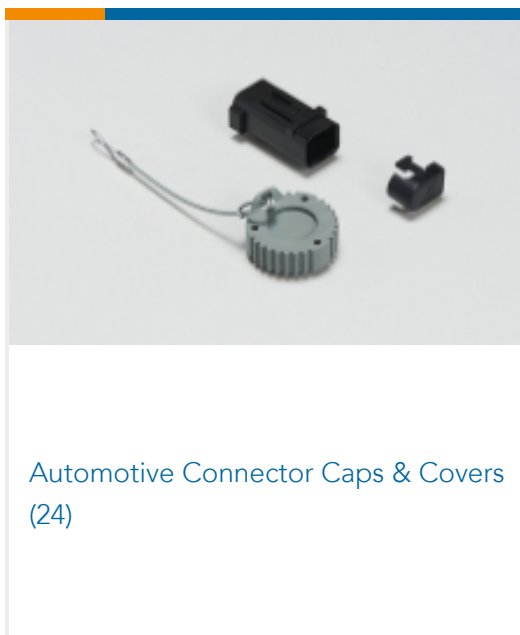

Automotive Connector Caps & Covers
(24)



Automotive Connector Locks &
Position Assurance(7)

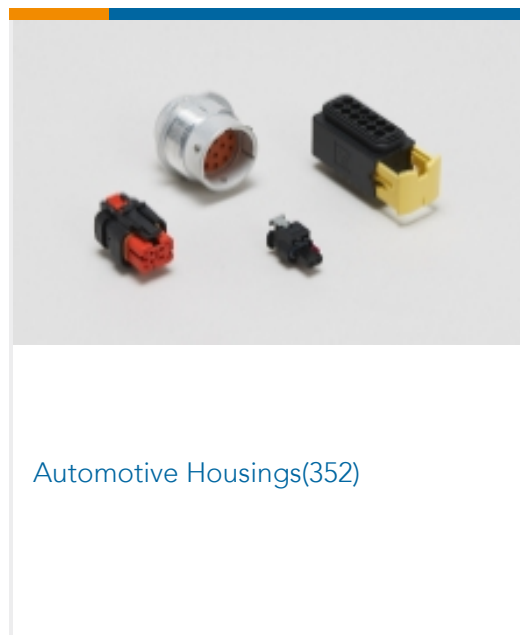

Automotive Housings(352)

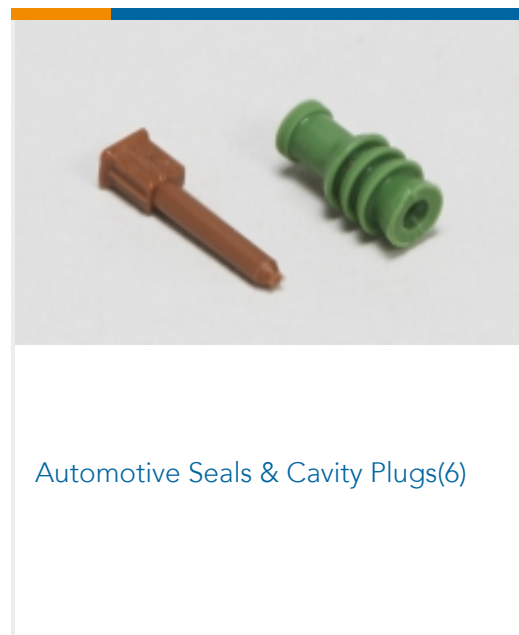

Automotive Seals & Cavity Plugs(6)



Automotive Terminals(125)



Insertion & Extraction Tools(13)

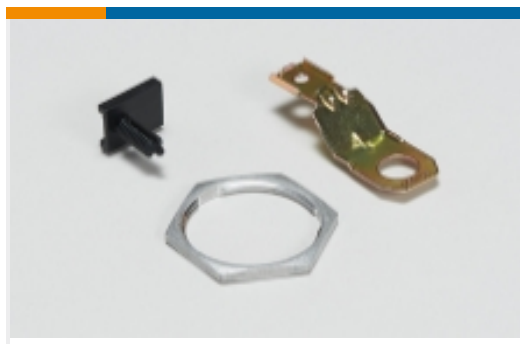

Other Automotive Connector Accessories(2)

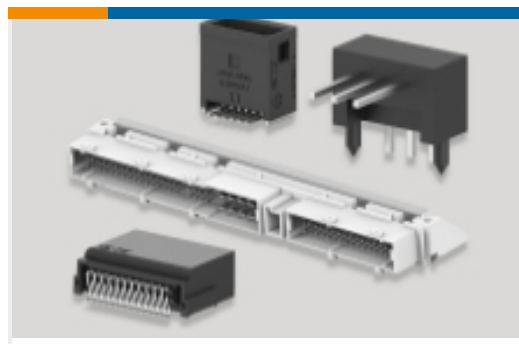

PCB Headers & Receptacles(29)

Customers Also Bought

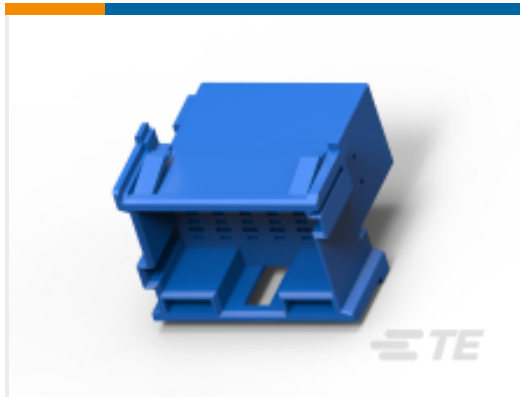

TE Part #1-967629-5
FLACHSTE-GEH2,8 18P



TE Part #2137358-1
AMP MCP, UNSEALED CONNECTOR HOUSING

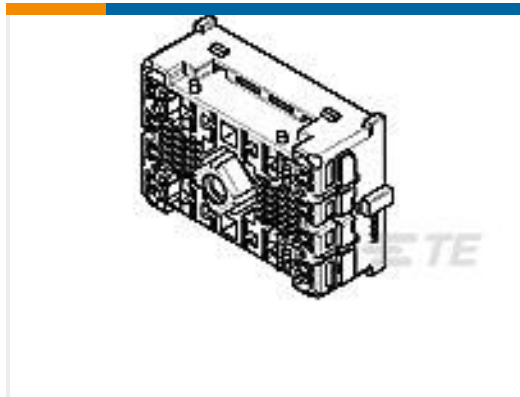

TE Part #179216-6
S/ALIGN. I/CONN PLUG ASSY 100P



TE Part #2304926-2
MINI-RELAY RETAINER

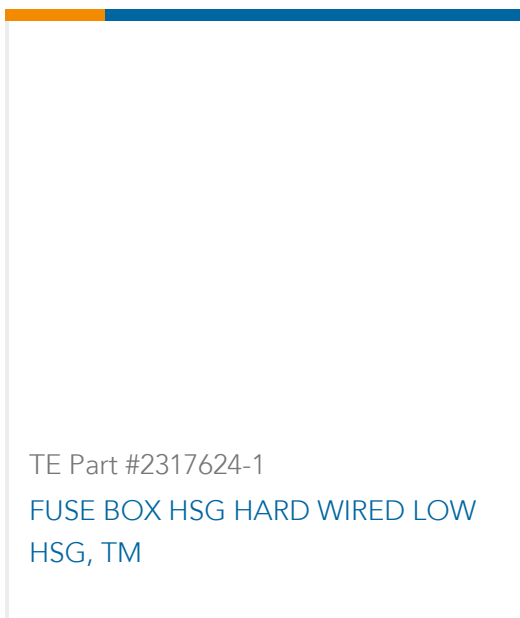

TE Part #2317624-1
FUSE BOX HSG HARD WIRED LOW HSG, TM

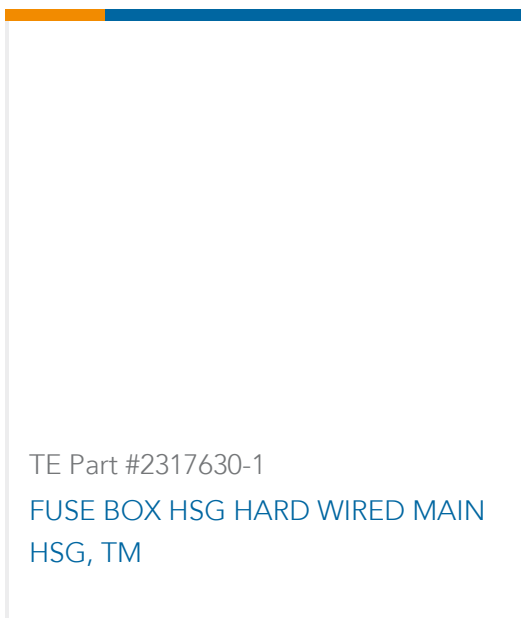

TE Part #2317630-1
FUSE BOX HSG HARD WIRED MAIN HSG, TM

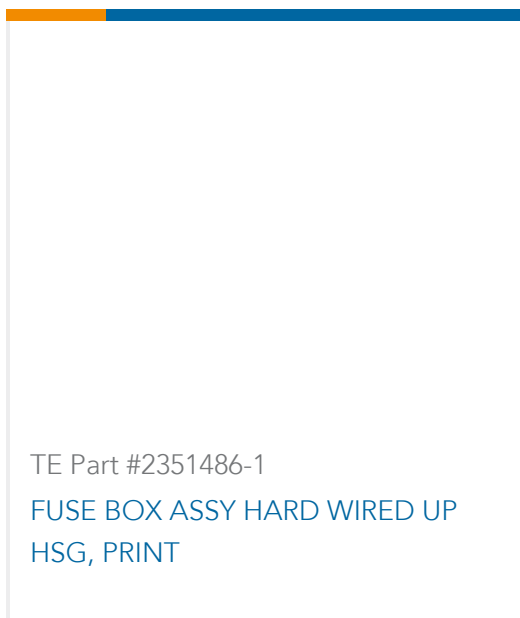

TE Part #2351486-1
FUSE BOX ASSY HARD WIRED UP HSG, PRINT



TE Part #3-1813099-1
2.5mm SOCKET HSG ASSEMBLY (GREEN 4POS)

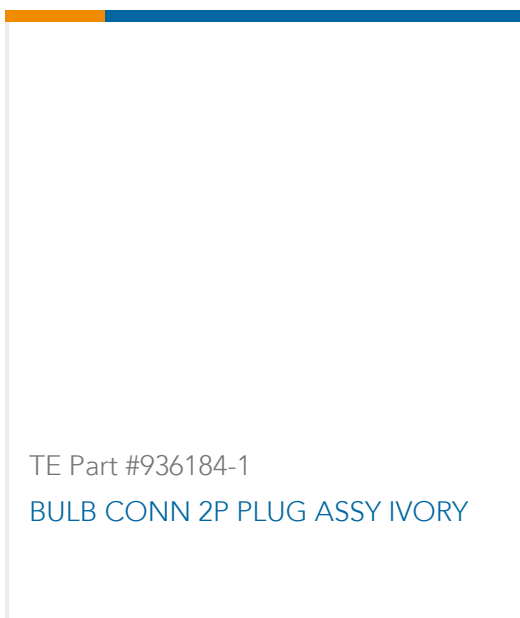

TE Part #936184-1
BULB CONN 2P PLUG ASSY IVORY

Documents

Product Drawings

[AMP-MCP 2.8mm RECEPTACLE HOUSING , 18POS](#)

English

CAD Files

[3D PDF](#)

[3D](#)

Customer View Model

[ENG_CVM_CVM_2137358-4_B.2d_dxf.zip](#)



English

Customer View Model

[ENG_CVM_CVM_2137358-4_B.3d_igs.zip](#)

English

Customer View Model

[ENG_CVM_CVM_2137358-4_B.3d_stp.zip](#)

English

By downloading the CAD file I accept and agree to the [Terms and Conditions](#) of use.

Product Specifications

[Application Specification](#)

English