



Connectors > Circular Connectors > Circular Connector Accessories > Unscreened Circular Connector Backshells & Clamps >

CPC SERIES 5 SEALED CABLE CLAMP



Backshell & Clamp Accessory Type: **Cable Clamp**

Compatible With Circular Connector Shell Size: **17**

Body Orientation: **Straight**

Accepts Cable Diameter (Max): **11.51 mm [.453 in]**

Protective Cover: **Without**

[All CPC SERIES 5 SEALED CABLE CLAMP \(2\)](#)

Features

Product Type Features

Product Type	Accessory
Backshell & Clamp Accessory Type	Cable Clamp
Protective Cover	Without

Body Features

Cable Clamp Material	Nylon
Cable Clamp Flammability Rating	UL 94V-1
Cable Clamp Color	Black

Mechanical Attachment

Screw & Hole Thread Size	15/16-20
--------------------------	----------

Housing Features

Body Orientation	Straight
------------------	----------

Dimensions



Accepts Cable Diameter (Max)	11.51 mm[.453 in]
------------------------------	-------------------

Operation/Application

Compatible With Circular Connector Shell Size	17
---	----

Packaging Features

Packaging Quantity	100
--------------------	-----

Packaging Method	Individual
------------------	------------

Product Compliance

[For compliance documentation, visit the product page on TE.com>](#)

EU RoHS Directive 2011/65/EU	Compliant
------------------------------	-----------

EU ELV Directive 2000/53/EC	Compliant
-----------------------------	-----------

China RoHS 2 Directive MIIT Order No 32, 2016	No Restricted Materials Above Threshold
---	---

EU REACH Regulation (EC) No. 1907/2006	Current ECHA Candidate List: JUNE 2022 (224) Candidate List Declared Against: JUNE 2022 (224) Does not contain REACH SVHC
--	---

Halogen Content	BFR/CFR/PVC Free, but Br/Cl >900 ppm in other sources.
-----------------	--

Solder Process Capability	Not applicable for solder process capability
---------------------------	--

Product Compliance Disclaimer

This information is provided based on reasonable inquiry of our suppliers and represents our current actual knowledge based on the information they provided. This information is subject to change. The part numbers that TE has identified as EU RoHS compliant have a maximum concentration of 0.1% by weight in homogenous materials for lead, hexavalent chromium, mercury, PBB, PBDE, DBP, BBP, DEHP, DIBP, and 0.01% for cadmium, or qualify for an exemption to these limits as defined in the Annexes of Directive 2011/65/EU (RoHS2). Finished electrical and electronic equipment products will be CE marked as required by Directive 2011/65/EU. Components may not be CE marked. Additionally, the part numbers that TE has identified as EU ELV compliant have a maximum concentration of 0.1% by weight in homogenous materials for lead, hexavalent chromium, and mercury, and 0.01% for cadmium, or qualify for an exemption to these limits as defined in the Annexes of Directive 2000/53/EC (ELV). Regarding the REACH Regulation, the information TE provides on SVHC in articles for this part number is based on the latest European Chemicals Agency (ECHA) 'Guidance on requirements for substances in articles' posted at this URL: <https://echa.europa.eu/guidance-documents/guidance-on-reach>

Compatible Parts



TE Part # 213906-1
CPC PLUG ASSY, SRS 6, SZ 17-10



TE Part # 213905-1
CPC PLUG ASSY, SERIES 5, SZ 17-3



TE Part # 213899-1
CPC SEAL ASSY KIT, SRS 5, 17-3



TE Part # 213900-1
CPC SEAL ASSY KIT, SRS 6, 17-10

Also in the Series | AMP CPC

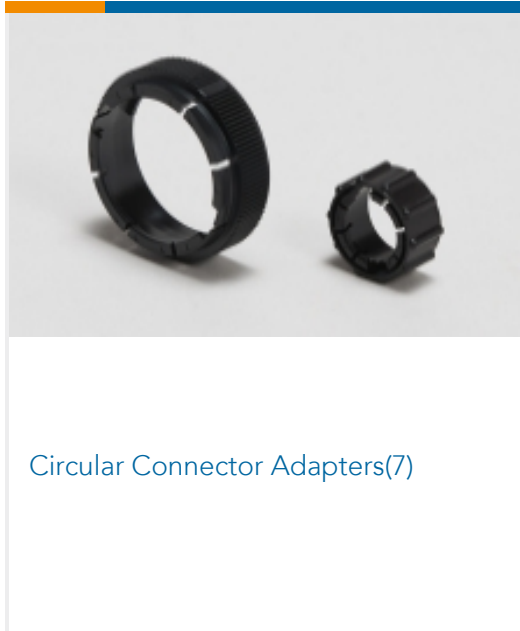

Circular Connector Adapters(7)

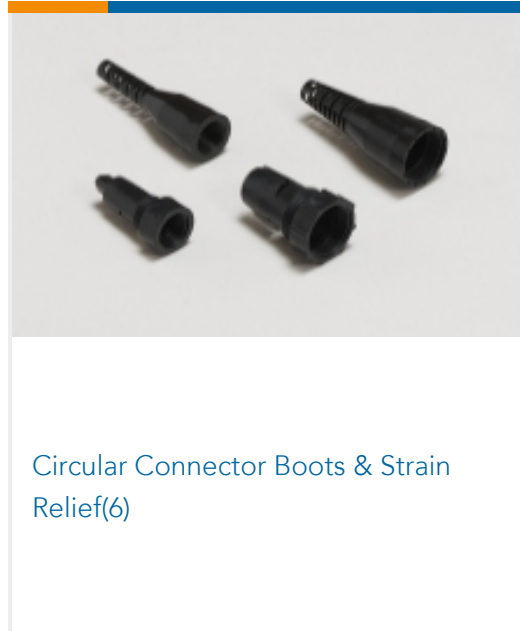

Circular Connector Boots & Strain Relief(6)

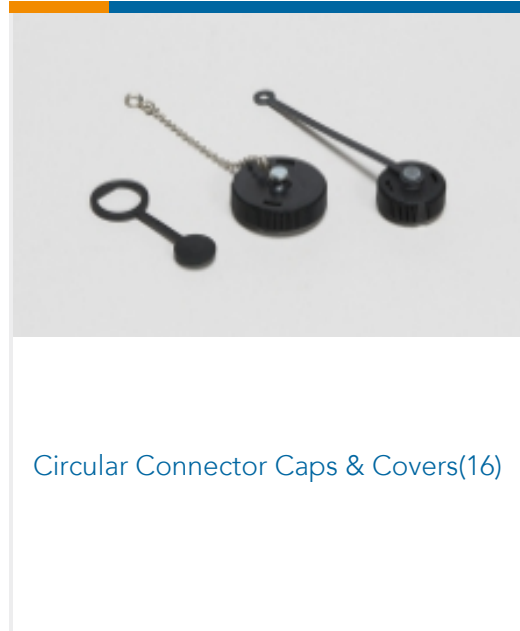

Circular Connector Caps & Covers(16)

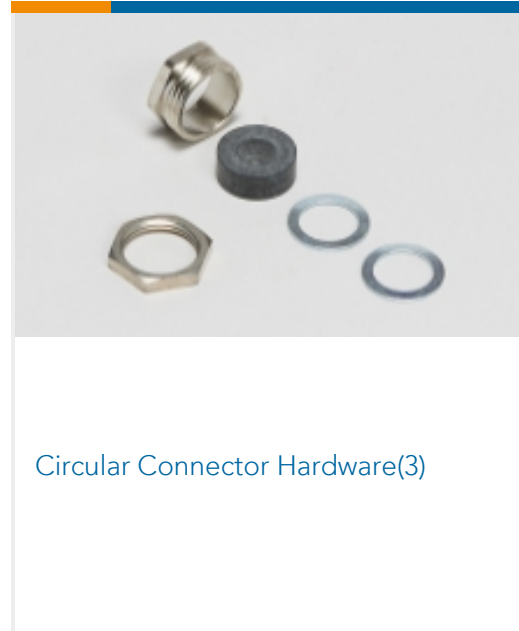

Circular Connector Hardware(3)

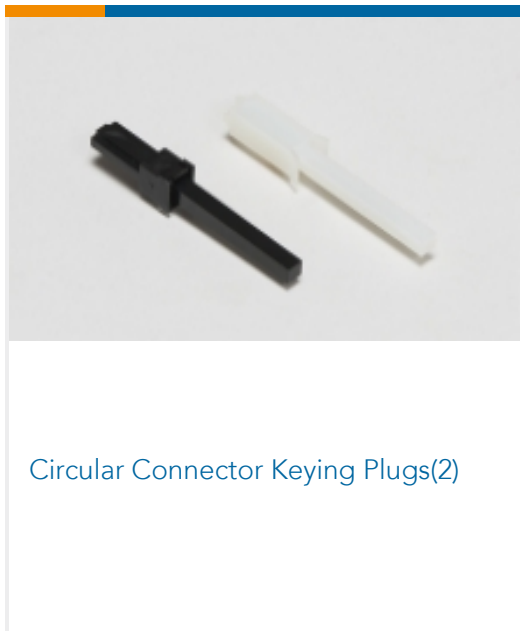

Circular Connector Keying Plugs(2)



Circular Connector Seals(36)

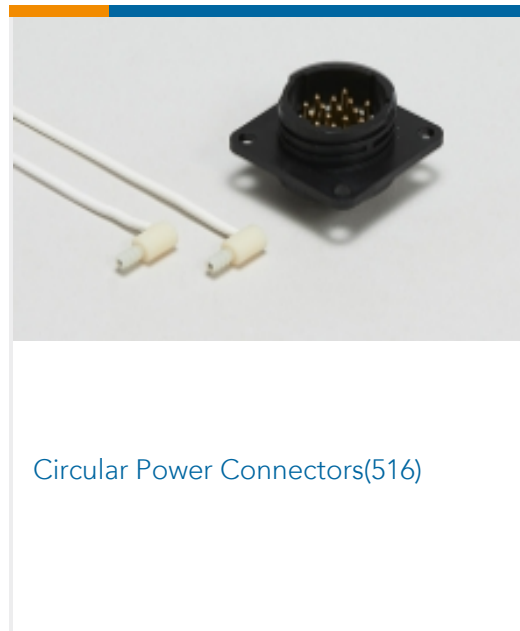

Circular Power Connectors(516)

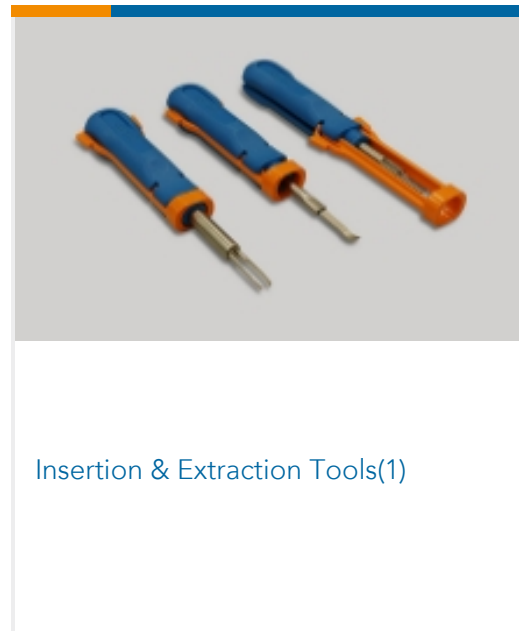

Insertion & Extraction Tools(1)

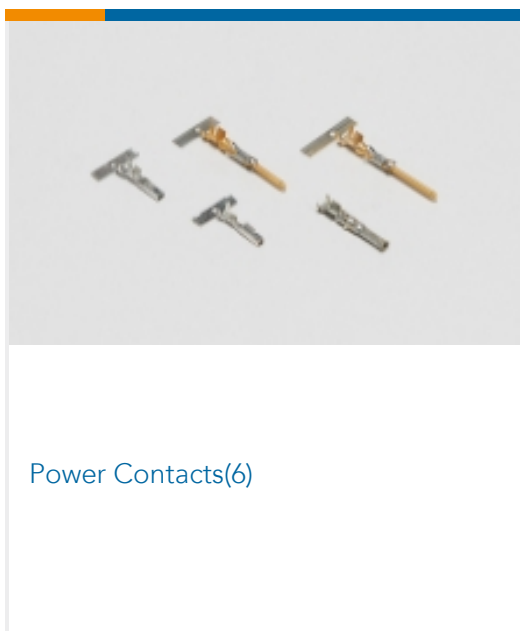

Power Contacts(6)

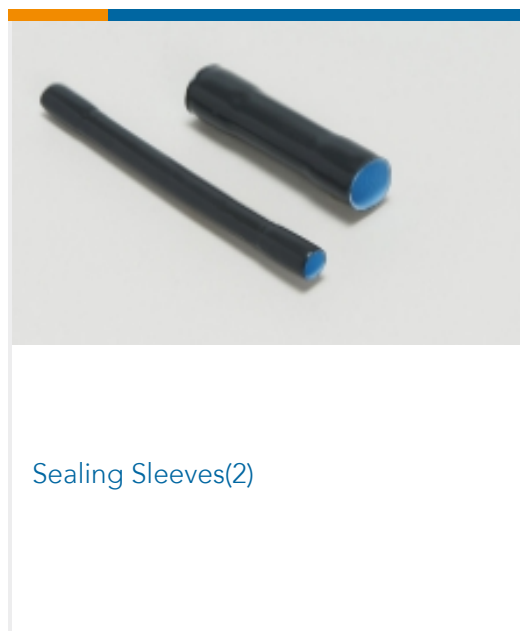

Sealing Sleeves(2)

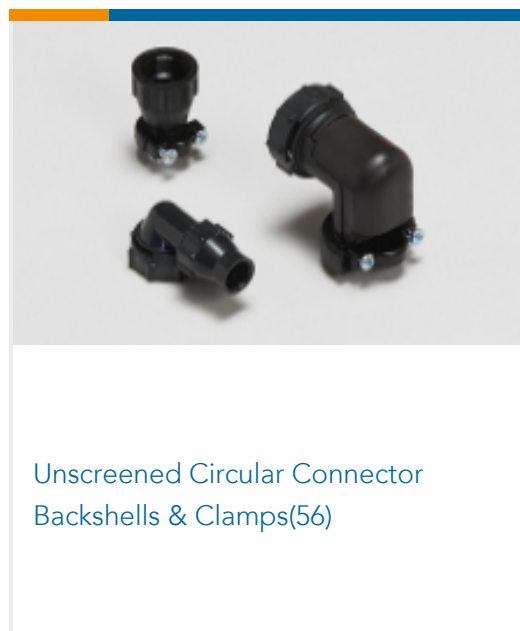

Unscreened Circular Connector Backshells & Clamps(56)

Customers Also Bought



TE Part #206137-2
23-7 FREE HANGING RECEPT



TE Part #DT04-12PA-E003
REC, 12P, GRY, N, CAP, A

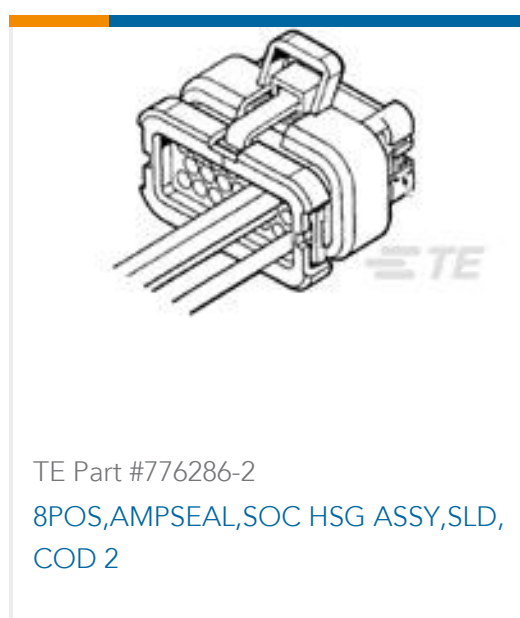

TE Part #776286-2
8POS, AMPSEAL, SOC HSG ASSY, SLD, COD 2



TE Part #213841-3
POWERBAND CONT ASSY, SILVER PLT, COD 2

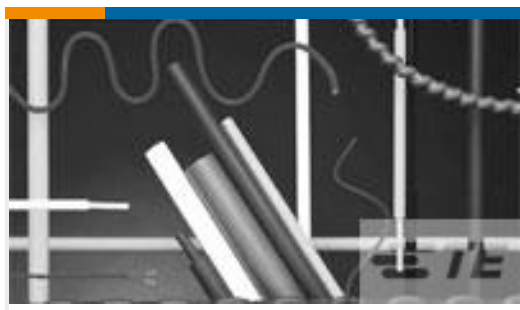

TE Part #5068084007
CGPT-9.5/4.8-2-SP



TE Part #DTM04-6P-E005
REC, 6P, BLK, N, CAP



TE Part #66259-4
MALE CONTACT ASSY. (L.P.)

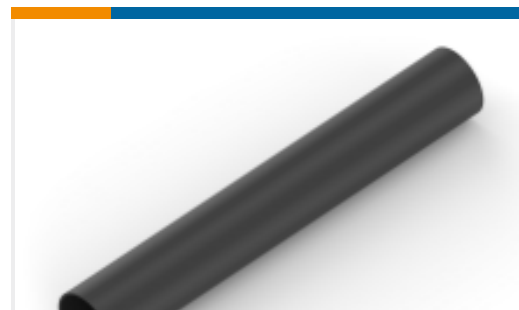

TE Part #NB17632001
TAT-125-1-1/2-0-STK

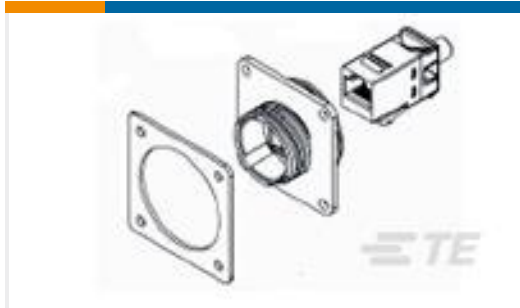

TE Part #1546908-1
CPC RCP ASSY, IND ETHERNET, SHLD

Documents

Product Drawings

[CPC CABLE CLAMP KIT, STD, SZ 17](#)

English

CAD Files

Customer View Model

[ENG_CVM_213904-3_A.3d_stp.zip](#)

English

Customer View Model

[ENG_CVM_213904-3_A.3d_igs.zip](#)

English

Customer View Model

[ENG_CVM_213904-3_A.2d_dxf.zip](#)

English

3D PDF

English

By downloading the CAD file I accept and agree to the [Terms and Conditions](#) of use.

Product Specifications

[Product Specification](#)

English