

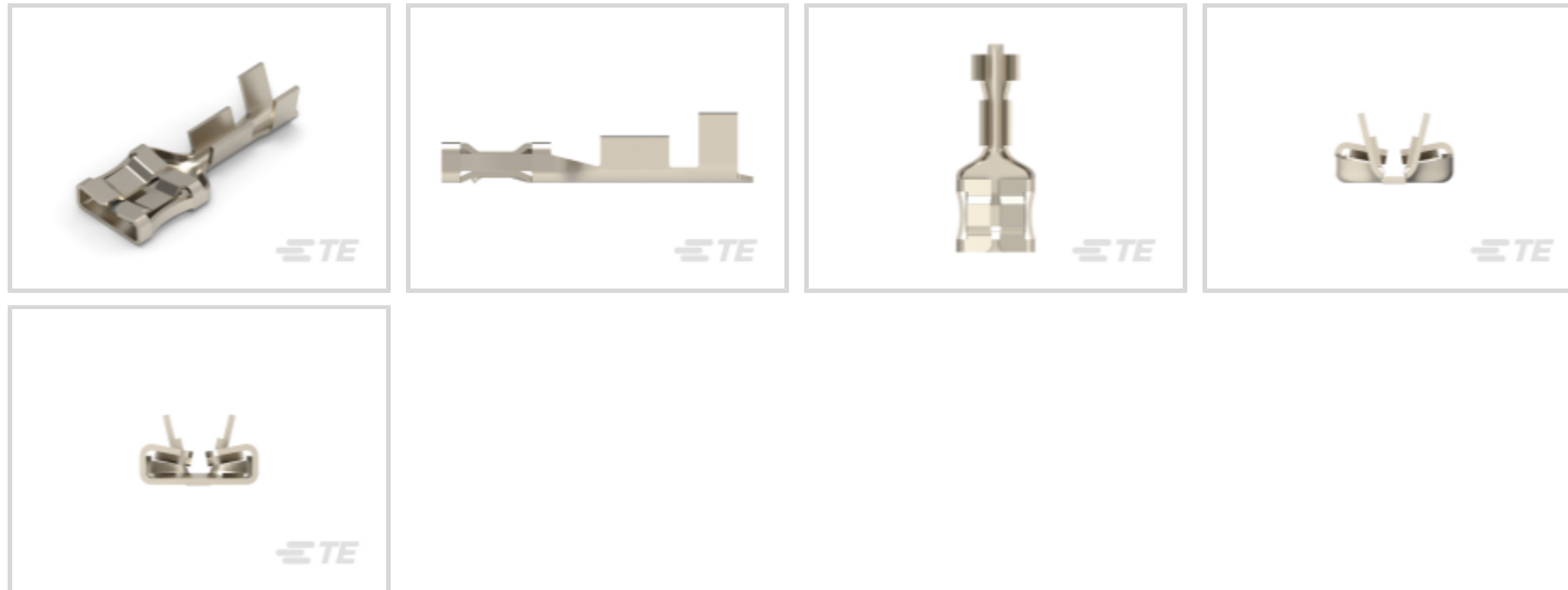

Terminals & Splices > Quick Disconnects



Quick Disconnect Terminal Type: **Receptacle**

Wire Size: .51 – .82 mm²

Mating Tab Width: 6.35 mm [.25 in]

Mating Tab Thickness: .81 mm [.032 in]

Features

Product Type Features

Terminates To	Wire & Cable
Wire/Cable Type	Regular Wire
Wire Stop	No
Insertion Force	Low
Sealable	No

Configuration Features

Connection Capacity	Single
---------------------	--------

Contact Features

Quick Disconnect Terminal Type	Receptacle
Mating Tab Width	6.35 mm [.25 in]
Mating Tab Thickness	.81 mm [.032 in]
Terminal Orientation	Straight
Contact Base Material	Steel
Terminal Plating Material	Pre-Nickel
Crimp Type	F-Crimp



Barrel Type	Open
-------------	------

Mechanical Attachment

Mating Retention Type	Dimple
Extraction Force	40 Newton
Wire Insulation Support	With

Dimensions

Accepts Wire Insulation Diameter Range	1.8 – 2.5 mm [.071 – .098 in]
Receptacle Terminal Stock Thickness	.41 mm [.016 in]
Overall Length	19 mm [.748 in]
Wire Size	.51 – .82 mm ²

Usage Conditions

Insulation Option	Uninsulated
Operating Temperature Range	-40 – 250 °C [-40 – 482 °F]

Industry Standards

UL Rating	Listed
-----------	--------

Packaging Features

Packaging Quantity	5000
Packaging Method	Strip/Reel

Other

Comment	With locking lance.
---------	---------------------

Product Compliance

[For compliance documentation, visit the product page on TE.com>](#)

EU RoHS Directive 2011/65/EU	Compliant
EU ELV Directive 2000/53/EC	Compliant
China RoHS 2 Directive MIIT Order No 32, 2016	No Restricted Materials Above Threshold
EU REACH Regulation (EC) No. 1907/2006	Current ECHA Candidate List: JUNE 2022 (224) Candidate List Declared Against: JAN 2022 (223) SVHC > Threshold: Not Yet Reviewed
Halogen Content	Low Halogen - Br, Cl, F, I < 900 ppm per homogenous material. Also BFR/CFR/PVC

Free

Solder Process Capability

Not reviewed for solder process capability

Product Compliance Disclaimer

This information is provided based on reasonable inquiry of our suppliers and represents our current actual knowledge based on the information they provided. This information is subject to change. The part numbers that TE has identified as EU RoHS compliant have a maximum concentration of 0.1% by weight in homogenous materials for lead, hexavalent chromium, mercury, PBB, PBDE, DBP, BBP, DEHP, DIBP, and 0.01% for cadmium, or qualify for an exemption to these limits as defined in the Annexes of Directive 2011/65/EU (RoHS2). Finished electrical and electronic equipment products will be CE marked as required by Directive 2011/65/EU. Components may not be CE marked. Additionally, the part numbers that TE has identified as EU ELV compliant have a maximum concentration of 0.1% by weight in homogenous materials for lead, hexavalent chromium, and mercury, and 0.01% for cadmium, or qualify for an exemption to these limits as defined in the Annexes of Directive 2000/53/EC (ELV). Regarding the REACH Regulation, the information TE provides on SVHC in articles for this part number is based on the latest European Chemicals Agency (ECHA) 'Guidance on requirements for substances in articles' posted at this URL: <https://echa.europa.eu/guidance-documents/guidance-on-reach>

Compatible Parts



TE Part # 2-2150340-1
OCEAN_2.0_Applicator-E-080F126F



TE Part # 2-2150340-2
OCEAN_2.0_Applicator-E-080F126F



TE Part # 2150340-1
OCEAN_2.0_Applicator-E-080F126F



TE Part # 2150340-2
OCEAN_2.0_Applicator-E-080F126F



TE Part # 7-2150340-1
OCEAN_2.0_Applicator-E-080F126F



TE Part # 7-2150340-2
OCEAN_2.0_Applicator-E-080F126F

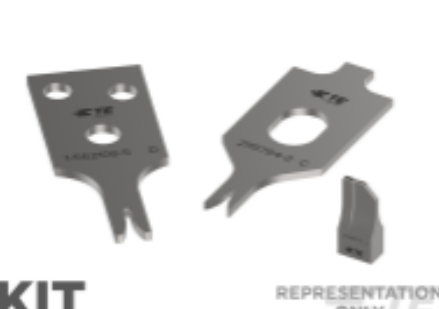

TE Part # 7-2150340-7
OCEAN_2.0_SPARE_PART_KIT-080F126F

Also in the Series | FASTON 250



Compression Connectors(4)

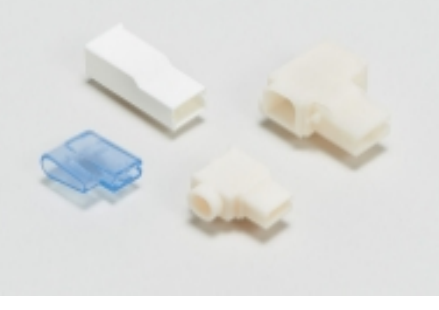

Crimp Terminal Housings(143)



Insertion & Extraction Tools(6)



Magnet Wire Terminals(1)



PCB Terminals(144)



Quick Disconnects(456)



Splices(4)

Customers Also Bought



TE Part #2-1676913-6
YR1 0.1% 1K0

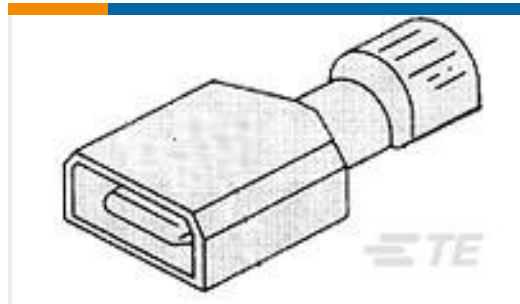

TE Part #4-521097-2
ULTRA-FAST 250 ASY TAB 12-10 AWG
TPBR

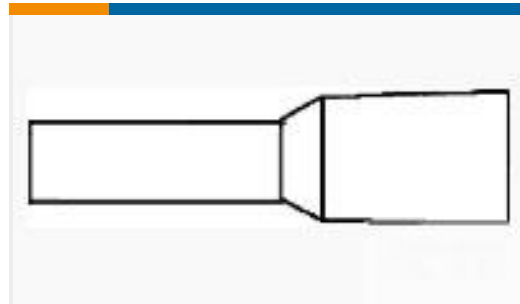

TE Part #966067-5
ADERENDHUELSE N GR



TE Part #1622796-6
YR1 0.1% 10K



TE Part #3-1676913-0
YR1 0.1% 20K



TE Part #2-320571-5
PIDG RING TONGUE TERMINALS



TE Part #599173-000
CWT-3802



TE Part #2178438-1
250 FASTON,F-SPR REC.,24-20 AWG,
PNST

Documents

Product Drawings

250 FASTON,F-SPR REC.,20-18 AWG,PNST

English

CAD Files

3D PDF

3D

Customer View Model

[ENG_CVM_CVM_2178299-1_B.2d_dxf.zip](#)

English

Customer View Model

[ENG_CVM_CVM_2178299-1_B.3d_igs.zip](#)

English

Customer View Model

[ENG_CVM_CVM_2178299-1_B.3d_stp.zip](#)

English

By downloading the CAD file I accept and agree to the [Terms and Conditions](#) of use.



Datasheets & Catalog Pages

F-spring Contact FASTON Terminal Flyer

English

White Paper - Improving Connector Reliability and Safety - F-Spring Contact FASTON Terminal

English

White Paper - Improving Connector Reliability and Safety - F-Spring Contact FASTON Terminal

English

Data sheet_2178299-1

English

Product Specifications

PRODUCT SPECIFICATION

English

Crimping for Faston steel Nickel plated product

English

Product Environmental Compliance

TE Material Declaration

English

Agency Approvals

VDE Certificate

English